

# 3RW30/3RW40 Soft Starters

Catalog News LV 1 N · January 2008



# sirius

[www.siemens.com/automation](http://www.siemens.com/automation)

**SIEMENS**

## Related catalogs

### Low-Voltage Controls and Distribution

SIRIUS · SENTRON · SIVACON  
Order No.:

Catalog LV 1  
E86060-K1002-A101-A7-7600  
Technical Information incl. LV 1 T



**Low-Voltage** LV 16  
Controls and Components  
for Applications according to UL  
Order no.:  
E86060-K1816-A101-A1-7600



### Industrial Communication

Industrial Communication  
for Automation and Drives  
Order No.:  
E86060-K6710-A101-B6-7600  
E86060-K6710-A121-A2-7600

IK PI  
IK PI N



**SICUBE** LV 50  
System Cubicles and  
Cubicle Air-Conditioning  
Order No.:  
E86060-K1920-A101-A3-7600



**SIDAC** LV 60  
Reactors and Filters  
Order No.:  
E86060-K2803-A101-A4-7600



**SIVACON 8PS** LV 70  
CD-K, BD01, BD2  
Busbar Trunking Systems  
up to 1250 A  
Order No.:  
E86060-K1870-A101-A3-7600



**Automation & Drives** CA 01  
The A&D Offline Mail  
CD-ROM:  
E86060-D4001-A110-C6-7600  
DVD:  
E86060-D4001-A510-C6-7600



**A&D Mail**  
Internet:  
<http://www.siemens.com/automation/mail>



**Catalog-PDF**  
Internet:  
<http://www.automation.siemens.com/cd>



## Contents

Systems • Controlgear: Contactors and contactor assemblies, solid-state switching devices • Protection equipment • Load feeders, motor starters and soft starters • Monitoring and control devices • Detecting devices • Commanding and signaling devices • Transformers • Power supplies • Planning and configuration with SIRIUS • Power Management System • SIVACON Power, distribution boards, busway and cubicle systems • SENTRON switching and protection devices for power distribution • Air circuit breakers, molded case circuit breakers, switch disconnectors • Software for power distribution • BETA low-voltage circuit protection

SIRIUS 3RV17 and 3RV18 circuit breakers according to UL 489 • SIVACON Components for 8US Distribution Systems according to UL 508A • SENTRON 3WL5 air circuit breakers/ non-automatic air circuit breakers according to UL 489/IEC • SENTRON 3VL Molded Case Circuit Breakers according to UL 489/IEC • ALPHA Devices according to UL Standard • BETA Devices according to UL standard

PROFINET/Industrial Ethernet • Industrial Mobile Communicator • PROFIBUS to IEC 61158/EN 50170 • SIMATIC ET 200 distributed I/Os • AS-Interface to EN 50295/IEC 61158 • Remote operation with SINAUT Telecontrol • Routers • ECOFAST system

System cubicles • Cubicle modifications • Cubicle expansion components • Accessories • Special cubicles  
Cubicle solutions in applications • Cubicle air-conditioning • Special colors

Commutating reactors for converters • Mains reactors for frequency converters • Iron-core output reactors • Ferrite output reactors • Iron-core smoothing reactors • Smoothing air-core reactors • Filter reactors • Application-specific reactors • Radio interference suppression filters • dv/dt filters • Sinewave filters

Busbar trunking systems, overview • CD-K system (25 A to 40 A) • BD01 system (40 A to 160 A) • BD2 system (160 A to 1250 A)

All Automation and Drives products, including those in the catalogs listed above.

All Automation and Drives products, including those in the catalogs listed above.

All catalogs for low-voltage controls and distribution can be downloaded as PDF files.

## Registered trademarks

All product designations may be registered trademarks or product names of Siemens AG or other supplying companies. Third parties using these trademarks or product names for their own purposes may infringe upon the rights of the trademark owners.

Further information about low-voltage controls is available on the Internet at:  
<http://www.siemens.com/lowvoltage>

## Technical Assistance



Expert technical assistance for Low-voltage controls and electrical installation.

**Tel.: +49 (9 11) 8 95-59 00**

**Fax: +49 (9 11) 8 95-59 07**

E-Mail: [technical-assistance@siemens.com](mailto:technical-assistance@siemens.com)

# 3RW30/3RW40 SIRIUS Soft Starters

## Catalog News LV 1 N · 01/2008

Invalid LV 1 · 2008 and LV 1 T · 2008,  
Chapter 6, Load Feeders, Motor Starters  
and Soft Starters,  
Section: 3RW30 and 3RW40 Soft Starters

Contact your local Siemens  
representative for further information

© Siemens AG 2008



*The products and systems listed in this catalog are manufactured using a certified quality management system which complies with EN ISO 9001 (for the Certificate Register No. see the Appendix). The TÜV certificate is recognized in all IQ Net countries.*

# SIEMENS



SIRIUS Industrial Controls	<b>1</b>	<b>Introduction</b> Siemens Automation and Drives. Welcome. Sharpen your competitive edge. Totally Integrated Automation. Integrated energy distribution from a single source. Totally Integrated Power. Low-Voltage Controls and Distribution - The basis for progressive solutions. SIRIUS Industrial Controls Low-Voltage Power Distribution	<b>11</b>	<b>Power Supplies</b> 4AV Non-Stabilized Power Supplies 6EP Stabilized Power Supplies - SITOP - LOGO!Power
	<b>2</b>	<b>Systems</b> AS-Interface ECOFASST System SIRIUS Safety Integrated PROFIBUS SIRIUS Modular System	<b>12</b>	<b>Engineering Software Planning and Configuration with SIRIUS</b> Motor Starter ES ECOFASST ES SIMOCODE ES Soft Starter ES
	<b>3</b>	<b>Controls – Contactors and Contactor Assemblies</b> 3RT, 3TB, 3TF Contactors for Switching Motors 3RA13, 3RA14, 3TD, 3TE Contactor Assemblies 3RT, 3RH, 3TB, 3TC, 3TH, 3TK Contactors for Special Applications 3RH, 3TH Contactor Relays · 3RT Coupling Relays 3TX7, 3RS18 Coupling Relays · LZS, LZX Plug-In Relays · 3TG10 Power Relays/Miniature Contactors	<b>13</b>	<b>Power Management System</b> System Overview - SIMATIC powercontrol - SIMATIC powercost
	<b>4</b>	<b>Controls – Solid-State Switching Devices</b> For resistive loads: 3RF20, 3RF21, 3RF22 Solid-State Relays 3RF23, 3RF24 Solid-State Contactors · 3RF29 Function Modules For switching motors: 3RF24 Solid-State Contactors and Solid-State Reversing Contactors	<b>14</b>	<b>SIVACON Power Distribution Boards, Busway Systems and Cubicle Systems</b> S8, 8PV and 8PT Power Distribution Boards and Motor Control Centers, 8PS Busbar Trunking Systems · 8MC, 8MF Cubicle Systems, 8MR, 8ME Cubicle Air-Conditioning ALPHA 630-DIN Floor-Mounted Distribution Boards · ALPHA FIX Terminal Blocks; ALPHA 8HP Molded-Plastic Distribution Systems Components for 8US, 8UC, 4NC Distribution Systems:
	<b>5</b>	<b>Protection Equipment</b> 3RV Motor Starter Protectors 3RB2 Solid-State Overload Relays 3RU1 Thermal Overload Relays	<b>15</b>	<b>SENTRON Switching and Protection Devices for Power Distribution</b> 3WL Air Circuit Breakers
	<b>6</b>	<b>Load Feeders, Motor Starters and Soft Starters</b> 3RW Soft Starters 3RA Fuseless Load Feeders 3RA71 Load Feeders with Safety Integrated AS-Interface Motor Starters and Soft Starters ET 200S, ET 200pro Motor Starters ET 200S Safety Motor Starter Solutions Local / PROFIsafe ECOFASST Motor Starters and Soft Starters 3RE Encapsulated Starters	<b>16</b>	<b>SENTRON Switching and Protection Devices for Power Distribution</b> 3VL, 3VF2 Molded Case Circuit Breakers
	<b>7</b>	<b>Monitoring and Control Devices</b> SIMOCODE 3UF Motor Management and Control Devices LOGO! Logic Modules · 3RP, 3RT19 Timing Relays 3UG Monitoring Relays for Electrical and Additional Measurements 3RS10, 3RS11 Temperature Monitoring Relays 3RN1 Thermistor Motor Protection 3TK28 Safety Relays 3RS17 Interface Converters	<b>17</b>	<b>SENTRON Switching and Protection Devices for Power Distribution</b> 3KA, 3KE, 3LD Switch Disconnectors 3KL, 3KM, 3NJ6 Switch Disconnectors with Fuses 3NP, 3NJ4, 3NJ5 Fuse Switch Disconnectors
	<b>8</b>	<b>Detecting Devices</b> 3SE2, 3SE3, 3SE5, 3SF1 Position Switches 3SF1 Hinge Switches 3SE6 Magnetically Operated Switches	<b>18</b>	<b>Software for Power Distribution</b> Dimensioning with SIMARIS design Configuring, Visualizing and Controlling with SIMATIC Configuring, Visualizing and Controlling with SENTRON
	<b>9</b>	<b>Commanding and Signaling devices</b> 3SB2, 3SB3, 3SF5 Pushbutton Units and Indicator Lights 3SE7, 3SF2 Cable-Operated Switches 3SE2, 3SE3 Foot Switches 8WD4 Signaling Columns 8WD5 Integrated Signal Lamps	<b>19</b>	<b>BETA Low-Voltage Circuit Protection</b> Miniature Circuit Breakers (MCBs) Residual Current Protective Devices Low-Voltage Fuse Systems SITOR Semiconductor Fuses SR 60 Busbar Systems Overvoltage Protection Devices Socket Outlets Measuring Devices
	<b>10</b>	<b>Transformers</b> Single-Phase Transformers Three-Phase Transformers	<b>20</b>	<b>Appendix</b> Glossary · Training · Ordering notes · Further documentation · Standards and approvals · Quality management · Online services · Customer support · Software licenses · Subject index Order number index including export markings · Terms and conditions of sale and delivery

# Explanations

## General information

### Things you should know about Catalog LV 1 · 2008 and Technical Information LV 1 T · 2008

Catalog LV 1 · 2008 contains selection- and order-relevant data under the topic headings "Overview", "Benefits", "Application", "Selection and ordering data", "Accessories", "Options" and "More information".

The topics "Design", "Function", "Integration", "Configuration", "Programming", "Technical specifications", "Characteristic curves", "Schematics" and "Dimensional drawings" can be found if required in the Technical Information LV 1 T · 2008.

The Technical Information LV 1 T is saved as a PDF file on the CD-ROM which is enclosed with this catalog (inside front cover).

### Delivery time class (DT)

▶ Preferred type	Preferred types are available immediately from stock, i.e. are dispatched within 24 hours.
A 2 working days	
B 1 week	Normal quantities of the products are usually delivered within the specified time following receipt of your order at our branch.
C 3 weeks	
D 6 weeks	In exceptional cases, the actual delivery time may differ from that specified.
X On request	

The delivery times apply up to the ramp at Siemens AG (products ready for dispatch). The transport times depend on the destination and type of shipping. The standard transport time for Germany is 1 day.

The delivery times specified here represent the state of 10/2007. They are permanently optimized. Up-to-date information can be found at <http://www.siemens.com/automation/mall>.

Note:

*For transformers, delivery time class B is applicable to an order quantity of up to 5 units. For an order quantity of more than 5 units, delivery time class C is applicable instead of delivery time class B.*

### Price units (PU)

The price unit defines the number of units, sets or meters to which the specified price and weight apply.

### Packaging sizes (PS)

The packaging size defines the number, e.g. of units, sets or meters, for outer packaging. Only the quantity defined by the packaging size or a multiple thereof can be ordered!

For multi-unit packing and reusable packaging see [Appendix](#)

### Price groups (PG)

Each product is assigned to a price group.

### Weight

The defined weight in kg refers to the price unit (PU).

### Dimensions

All dimensions in mm.

## Order number index

### Order number index with export regulation

Order number	Export regulation		Page
	ECCN	AL	
<b>3R</b>			
3RA	N	N	6/5, 6/11
3RP	N	N	6/5
3RT	N	N	6/5, 6/10
3RU19 00-1	N	N	6/10
3RU19 00-2	N	N	6/10
3RW30 0	N	N	6/4
3RW30 1	N	N	6/4
3RW30 2	N	N	6/4
3RW30 3	EAR99	N	6/4
3RW30 4	EAR99	N	6/4
3RW40 2	N	N	6/7 ... 8
3RW40 3	N	N	6/7 ... 8
3RW40 4	N	N	6/7 ... 8
3RW40 5	N	N	6/9
3RW40 7	N	N	6/9
3RW49	N	N	6/10 ... 11

Order number	Export regulation		Page
	ECCN	AL	
<b>3S</b>			
3SB	N	N	6/10
3SX	N	N	6/10
<b>3Z</b>			
3ZX	on request		6/5, 6/11

# 3RW30/3RW40 SIRIUS Soft Starters



Catalog	3RW Soft Starters
	General data
6/2	- Overview
	3RW30 for standard applications
6/3	- Overview
6/3	- Application
6/4	- Selection and ordering data
	3RW40 for standard applications
6/6	- Overview
6/6	- Application
6/7	- Selection and ordering data
Technical Information	3RW Soft Starters
	3RW30 for standard applications
6/12	- Function
6/12	- Technical specifications
6/21	- Characteristic curves
6/21	- More information
	3RW40 for standard applications
6/23	- Function
6/24	- Technical specifications
6/34	- Characteristic curves
6/35	- More information
	Project planning aids
6/37	- Dimensional drawings
6/39	- Schematics





# 3RW Soft Starters

## General data

### Overview

The advantages of the SIRIUS soft starters at a glance:

- Soft starting and smooth ramp-down<sup>1)</sup>
- Stepless starting
- Reduction of current peaks
- Avoidance of mains voltage fluctuations during starting
- Reduced load on the power supply network
- Reduction of the mechanical load in the operating mechanism
- Considerable space savings and reduced wiring compared with conventional starters
- Maintenance-free switching
- Very easy handling
- Fits perfectly in the SIRIUS modular system



		SIRIUS 3RW30 Standard applications	SIRIUS 3RW40 Standard applications	SIRIUS 3RW44 High-Feature applications
Rated current up to 40 °C	A	3 ... 106	12.5 ... 432	29 ... 1214
Rated operational voltage	V	200 ... 480	200 ... 600	200 ... 690
Motor rating at 400 V				
• Inline circuit	kW	1.5 ... 55	5.5 ... 250	15 ... 710
• Inside-delta circuit	kW	--	--	22 ... 1200
Ambient temperature	°C	-25 ... +60	-25 ... +60	0 ... +60
Soft starting/ramp-down		✓ <sup>1)</sup>	✓	✓
Voltage ramp		✓	✓	✓
Starting/stopping voltage	%	40 ... 100	40 ... 100	20 ... 100
Starting and ramp-down time	s	0 ... 20	0 ... 20	1 ... 360
Torque control		--	--	✓
Starting/stopping torque	%	--	--	20 ... 100
Torque limit	%	--	--	20 ... 200
Ramp time	s	--	--	1 ... 360
Integral bypass contact system		✓	✓	✓
Intrinsic device protection		--	✓	✓
Motor overload protection		--	✓	✓
Thermistor motor protection		--	✓ <sup>2)</sup>	✓
Integrated remote RESET		--	✓ <sup>3)</sup>	✓
Adjustable current limiting		--	✓	✓
Inside-delta circuit		--	--	✓
Breakaway pulse		--	--	✓
Creep speed in both directions of rotation		--	--	✓
Pump ramp-down		--	--	✓ <sup>4)</sup>
DC braking		--	--	✓ <sup>4) 5)</sup>
Combined braking		--	--	✓ <sup>4) 5)</sup>
Motor heating		--	--	✓
Communication		--	--	with PROFIBUS DP (optional)
External display and operator module		--	--	(optional)
Operating measured value display		--	--	✓
Error logbook		--	--	✓
Event list		--	--	✓
Slave pointer function		--	--	✓
Trace function		--	--	✓ <sup>6)</sup>
Programmable control inputs and outputs		--	--	✓
Number of parameter sets		1	1	3
Parameterization software (Soft Starter ES)		--	--	✓
Power semiconductors (thyristors)		2 controlled phases	2 controlled phases	3 controlled phases
Screw terminals		✓	✓	✓
Spring-loaded terminals		✓	✓	✓
UL/CSA		✓	✓	✓
CE marking		✓	✓	✓
Soft starting under heavy starting conditions		--	--	✓ <sup>4)</sup>

#### Configuring support

Win-Soft Starter, electronic selection slider ruler, Technical Assistance ++49 911 895 5900

✓ Function is available; -- Function is not available.

<sup>1)</sup> Only soft starting available for 3RW30.

<sup>2)</sup> Optional up to size S3 (device variant).

<sup>3)</sup> Available for 3RW40 2. to 3RW40 4.; optional for 3RW40 5. and 3RW40 7..

<sup>4)</sup> Calculate soft starter and motor with size allowance where required.

<sup>5)</sup> Not possible in inside-delta circuit.

<sup>6)</sup> Trace function with Soft Starter ES software.

More information can be found on the Internet at

<http://www.siemens.com/softstarter>



**Overview**

The SIRIUS 3RW30 soft starters reduce the motor voltage through variable phase control and increase it in ramp-like mode from a selectable starting voltage up to mains voltage. During starting, these devices limit the torque as well as the current and prevent the shocks which arise during direct starts or wye-delta starts. In this way, mechanical loads and mains voltage dips can be reliably reduced.

Soft starting reduces the stress on the connected equipment and results in lower wear and therefore longer periods of trouble-free production. The selectable start value means that the soft starters can be adjusted individually to the requirements of the application in question and unlike wye-delta starters are not restricted to two-stage starting with fixed voltage ratios.

The SIRIUS 3RW30 soft starters are characterized above all by their small space requirements. Integrated bypass contacts mean that no power loss has to be taken into the bargain at the power semiconductors (thyristors) after the motor has started up. This cuts down on heat losses, enabling a more compact design and making external bypass circuits superfluous.

Various versions of the SIRIUS 3RW30 soft starters are available:

- Standard version for fixed-speed three-phase motors, sizes S00, S0, S2 and S3, with integrated bypass contact system
- Version for fixed-speed three-phase motors in a 22.5 mm enclosure without bypass

Soft starters rated up to 55 kW (at 400 V) for standard applications in three-phase networks are available. Extremely small sizes, low power losses and simple start-up are just three of the many advantages of this soft starter.

**Application**

The 3RW30 soft starters are suitable for soft starting of three-phase asynchronous motors.

Due to two-phase control, the current is kept at minimum values in all three phases throughout the entire starting time. Due to continuous voltage influencing, current and torque peaks, which are unavoidable in the case of wye-delta starters, for instance, do not occur.

**Application areas**

- Pumps
- Heat pumps
- Hydraulic pumps
- Presses
- Conveyors
- Roller conveyors
- Screw conveyors

# 3RW Soft Starters

## 3RW30 for standard applications

### Selection and ordering data



Ambient temperature 40 °C				Ambient temperature 50 °C				Size	DT	Order No.	Price per PU	PU (UNIT, SET, M)	PS*	PG	Weight per PU approx. kg
Rated operational current $I_e^{1)}$	Rated power of three-phase induction motors for rated operational voltage $U_e$			Rated operational current $I_e^{1)}$	Rated power of three-phase induction motors for rated operational voltage $U_e$										
A	230 V	400 V	500 V	A	200 V	230 V	460 V	575 V							
	kW	kW	kW		hp	hp	hp	hp							

#### Rated operational voltage $U_e$ 200 ... 480 V<sup>2)</sup>

- With screw terminals

3.6	0.75	1.5	--	3	0.5	0.5	1.5	--	S00	▶	3RW30 13-1BB□4	1	1 unit	131	0.580
6.5	1.5	3	--	4.8	1	1	3	--	S00	▶	3RW30 14-1BB□4	1	1 unit	131	0.580
9	2.2	4	--	7.8	2	2	5	--	S00	▶	3RW30 16-1BB□4	1	1 unit	131	0.580
12.5	3	5.5	--	11	3	3	7.5	--	S00	▶	3RW30 17-1BB□4	1	1 unit	131	0.580
17.6	4	7.5	--	17	3	3	10	--	S00	▶	3RW30 18-1BB□4	1	1 unit	131	0.580

- With spring-loaded terminals

3.6	0.75	1.5	--	3	0.5	0.5	1.5	--	S00	B	3RW30 13-2BB□4	1	1 unit	131	0.580
6.5	1.5	3	--	4.8	1	1	3	--	S00	B	3RW30 14-2BB□4	1	1 unit	131	0.580
9	2.2	4	--	7.8	2	2	5	--	S00	B	3RW30 16-2BB□4	1	1 unit	131	0.580
12.5	3	5.5	--	11	3	3	7.5	--	S00	B	3RW30 17-2BB□4	1	1 unit	131	0.580
17.6	4	7.5	--	17	3	3	10	--	S00	B	3RW30 18-2BB□4	1	1 unit	131	0.580

- With screw terminals

25	5.5	11	--	23	5	5	15	--	S0	▶	3RW30 26-1BB□4	1	1 unit	131	0.690
32	7.5	15	--	29	7.5	7.5	20	--	S0	▶	3RW30 27-1BB□4	1	1 unit	131	0.690
38	11	18.5	--	34	10	10	25	--	S0	▶	3RW30 28-1BB□4	1	1 unit	131	0.690

- With spring-loaded terminals

25	5.5	11	--	23	5	5	15	--	S0	B	3RW30 26-2BB□4	1	1 unit	131	0.690
32	7.5	15	--	29	7.5	7.5	20	--	S0	B	3RW30 27-2BB□4	1	1 unit	131	0.690
38	11	18.5	--	34	10	10	25	--	S0	B	3RW30 28-2BB□4	1	1 unit	131	0.690

- With screw-type or spring-loaded terminals

45	11	22	--	42	10	15	30	--	S2	B	3RW30 36-□BB□4	1	1 unit	131	1.200
63	18.5	30	--	58	15	20	40	--	S2	B	3RW30 37-□BB□4	1	1 unit	131	1.200
72	22	37	--	62	20	20	40	--	S2	B	3RW30 38-□BB□4	1	1 unit	131	1.200

- With screw-type or spring-loaded terminals

80	22	45	--	73	20	25	50	--	S3	B	3RW30 46-□BB□4	1	1 unit	131	1.710
106	30	55	--	98	30	30	75	--	S3	B	3RW30 47-□BB□4	1	1 unit	131	1.710

#### Order No. supplement for connection types

- With screw terminals
- With spring-loaded terminals<sup>3)</sup>

#### Order No. supplement for rated control supply voltage $U_s$

- 24 V AC/DC
- 110 ... 230 V AC/DC

1  
2  
0  
1

#### Soft starters for easy starting conditions and high switching frequency, rated operational voltage $U_e$ 200 ... 400 V, rated control supply voltage $U_s$ 24 ... 230 V AC/DC

3	0.55	1.1	--	2.6	0.5	0.5	--	--	22.5 mm	▶	3RW30 03-1CB54	1	1 unit	131	0.207
										A	3RW30 03-2CB54	1	1 unit	131	0.188

1) Stand-alone installation.

2) Soft starter with screw terminals: delivery time class ▶ (preferred type).

3) Main circuit connection: screw terminals.

#### Note:

Selection of the soft starter depends on the rated motor current.

The SIRIUS 3RW30 solid-state soft starters are designed for easy starting conditions.  $J_{Load} < 10 \times J_{Motor}$ . In the event of deviating conditions or increased switching frequency, it may be necessary to choose a larger device.



Siemens recommends the use of the selection and simulation program Win-Soft Starter. For information about rated currents for ambient temperatures > 40 °C, see technical specifications (see Technical Information LV 1 T).

\* You can order this quantity or a multiple thereof.

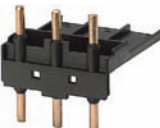
## Accessories

For soft starters		Motor starter protectors		DT	Order No.	Price per PU	PU (UNIT, SET, M)	PS*	PG	Weight per PU approx. kg
Type	Size	Size	Size							
<b>Auxiliary terminals</b>										
<b>Auxiliary terminals, 3-pole</b>										
3RW30 4.	<b>S3</b>			B	<b>3RT19 46-4F</b>		1	1 unit	101	0.035
<b>Covers for soft starters</b>										
<b>Terminal covers for box terminals</b>										
Additional touch protection to be fitted at the box terminals (2 units required per device)										
3RW30 3.	<b>S2</b>			▶	<b>3RT19 36-4EA2</b>		1	1 unit	101	0.020
3RW30 4.	<b>S3</b>			▶	<b>3RT19 46-4EA2</b>		1	1 unit	101	0.025
<b>Terminal covers for cable lugs and busbar connections</b>										
For complying with the phase clearances and as touch protection if box terminal is removed (2 units required per contactor)										
3RW30 4.	<b>S3</b>			▶	<b>3RT19 46-4EA1</b>		1	1 unit	101	0.040
<b>Link modules to motor starter protectors</b>										
	3RW30 13,	<b>S00</b>	<b>S0</b>	▶	<b>3RA19 21-1A</b>		1	10 units	101	0.028
	3RW30 14,									
	3RW30 16,			▶	<b>3RA19 21-1A</b>		1	10 units	101	0.028
	3RW30 17,			D	<b>3RA19 31-1D</b>		1	5 units	101	0.041
	3RW30 18									
	3RW30 26	<b>S0</b>	<b>S0</b>	▶	<b>3RA19 21-1A</b>		1	10 units	101	0.028
	3RW30 27,		<b>S2</b>	D	<b>3RA19 31-1D</b>		1	5 units	101	0.041
	3RW30 28									
	3RW30 36	<b>S2</b>	<b>S2</b>	▶	<b>3RA19 31-1A</b>		1	5 units	101	0.033
	3RW30 37,		<b>S3</b>	D	<b>3RA19 41-1D</b>		1	5 units	101	0.042
	3RW30 38									
	3RW30 46,	<b>S3</b>	<b>S3</b>	▶	<b>3RA19 41-1A</b>		1	5 units	101	0.072
	3RW30 47									
<b>Operating instructions<sup>1)</sup></b>										
For soft starters										
3RW30 1.	<b>S00</b>				<b>3ZX10 12-0RW30-2DA1</b>					
3RW30 2.	<b>S0</b>									
3RW30 3.	<b>S2</b>									
3RW30 4.	<b>S3</b>									

<sup>1)</sup> The operating instructions are included in the scope of supply.

Version	Functionality Functions	Use	DT	Order No.	Price per PU	PU (UNIT, SET, M)	PS*	PG	Weight per PU approx. kg	
<b>Covers and push-in lugs (only for 3RW30 03)</b>										
	<b>Sealable covers</b>	For securing against unauthorized adjustment of setting knobs	For devices with 1 or 2 CO contacts	▶	<b>3RP19 02</b>		1	5 units	101	0.004
	3RP19 02									
	<b>Push-in lugs for screw mounting</b>		For devices with 1 or 2 CO contacts	▶	<b>3RP19 03</b>		1	10 units	101	0.002
	3RP19 03									

\* You can order this quantity or a multiple thereof.

# 3RW Soft Starters

## 3RW40 for standard applications

### Overview

SIRIUS 3RW40 soft starters have all the same advantages as the 3RW30 soft starters.

The SIRIUS 3RW40 soft starters are characterized above all by their small space requirements. Integrated bypass contacts mean that no power loss has to be taken into the bargain at the power semiconductors (thyristors) after the motor has started up. This cuts down on heat losses, enabling a more compact design and making external bypass circuits superfluous.

At the same time this soft starter comes with additional integrated functions such as adjustable current limiting, motor overload and intrinsic device protection, and optional thermistor motor protection. The higher the motor rating, the more important these functions because they make it unnecessary to purchase and install protection equipment such as overload relays.

Internal intrinsic device protection prevents the thermal overloading of the thyristors and the power section defects this can cause. As an option the thyristors can also be protected by semiconductor fuses from short-circuiting.

Thanks to integrated status monitoring and fault monitoring, this compact soft starter offers many different diagnostics options. Up to four LEDs and relay outputs permit differentiated monitoring and diagnosis of the operating mechanism by indicating the operating state as well as for example mains or phase failure, missing load, non-permissible tripping time/class setting, thermal overloading or device faults.

Soft starters rated up to 250 kW (at 400 V) for standard applications in three-phase networks are available. Extremely small sizes, low power losses and simple start-up are just three of the many advantages of the SIRIUS 3RW40 soft starters.

### **"Increased safety" type of protection EEx e according to ATEX directive 94/9/EC**

The 3RW40 soft starters size S6, S10 and S12 are suitable for starting explosion-proof motors with "increased safety" type of protection EEx e;

see Catalog LV 1 "Appendix" -> "Standards and approvals" -> "Type overview of approved devices for explosion-protected areas (ATEX explosion protection)".

### Application

The SIRIUS 3RW40 solid-state soft starters are suitable for soft starting and stopping of three-phase asynchronous motors.

Due to two-phase control, the current is kept at minimum values in all three phases throughout the entire starting time and disturbing direct current components are eliminated in addition. This not only enables the two-phase starting of motors up to 250 kW (at 400 V) but also avoids the current and torque peaks which occur e.g. with wye-delta starters.

### Application areas

- Pumps
- Heat pumps
- Hydraulic pumps
- Presses
- Conveyors
- Roller conveyors
- Screw conveyors
- Escalators
- Piston compressors
- Screw compressors
- Small fans
- Centrifugal blowers
- Bow thrusters
- Stirrers
- Extruders
- Lathes
- Milling machines

## Selection and ordering data



3RW40 28-1BB14



3RW40 38-1BB14



3RW40 47-1BB14

Ambient temperature 40 °C				Ambient temperature 50 °C				Size	DT	Order No.	Price per PU	PU (UNIT, SET, M)	PS*	PG	Weight per PU approx. kg
Rated power of three-phase induction motors for rated operational voltage $U_e$				Rated power of three-phase induction motors for rated operational voltage $U_e$											
Rated operational current $I_e^{1)}$	230 V			400 V			500 V								
	A	kW	kW	kW	A	hp	hp	hp	hp						
<b>Rated operational voltage <math>U_e</math> 200 ... 480 V<sup>2)</sup></b>															
• With screw terminals															
12.5	3	5.5	--	11	3	3	7.5	--	S0	▶	3RW40 24-1BB□4	1	1 unit	131	0.770
25	5.5	11	--	23	5	5	15	--	S0	▶	3RW40 26-1BB□4	1	1 unit	131	0.770
32	7.5	15	--	29	7.5	7.5	20	--	S0	▶	3RW40 27-1BB□4	1	1 unit	131	0.770
38	11	18.5	--	34	10	10	25	--	S0	▶	3RW40 28-1BB□4	1	1 unit	131	0.770
• With spring-loaded terminals															
12.5	3	5.5	--	11	3	3	7.5	--	S0	B	3RW40 24-2BB□4	1	1 unit	131	0.770
25	5.5	11	--	23	5	5	15	--	S0	B	3RW40 26-2BB□4	1	1 unit	131	0.770
32	7.5	15	--	29	7.5	7.5	20	--	S0	B	3RW40 27-2BB□4	1	1 unit	131	0.770
38	11	18.5	--	34	10	10	25	--	S0	B	3RW40 28-2BB□4	1	1 unit	131	0.770
• With screw-type or spring-loaded terminals															
45	11	22	--	42	10	15	30	--	S2	B	3RW40 36-□BB□4	1	1 unit	131	1.350
63	18.5	30	--	58	15	20	40	--	S2	B	3RW40 37-□BB□4	1	1 unit	131	1.350
72	22	37	--	62	20	20	40	--	S2	B	3RW40 38-□BB□4	1	1 unit	131	1.350
• With screw-type or spring-loaded terminals															
80	22	45	--	73	20	25	50	--	S3	B	3RW40 46-□BB□4	1	1 unit	131	1.900
106	30	55	--	98	30	30	75	--	S3	B	3RW40 47-□BB□4	1	1 unit	131	1.900
<b>Rated operational voltage <math>U_e</math> 400 ... 600 V</b>															
• With screw terminals															
12.5	--	5.5	7.5	11	--	--	7.5	10	S0	B	3RW40 24-1BB□5	1	1 unit	131	0.770
25	--	11	15	23	--	--	15	20	S0	B	3RW40 26-1BB□5	1	1 unit	131	0.770
32	--	15	18.5	29	--	--	20	25	S0	B	3RW40 27-1BB□5	1	1 unit	131	0.770
38	--	18.5	22	34	--	--	25	30	S0	B	3RW40 28-1BB□5	1	1 unit	131	0.770
• With spring-loaded terminals															
12.5	--	5.5	7.5	11	--	--	7.5	10	S0	B	3RW40 24-2BB□5	1	1 unit	131	0.770
25	--	11	15	23	--	--	15	20	S0	B	3RW40 26-2BB□5	1	1 unit	131	0.770
32	--	15	18.5	29	--	--	20	25	S0	B	3RW40 27-2BB□5	1	1 unit	131	0.770
38	--	18.5	22	34	--	--	25	30	S0	B	3RW40 28-2BB□5	1	1 unit	131	0.770
• With screw-type or spring-loaded terminals															
45	--	22	30	42	--	--	30	40	S2	B	3RW40 36-□BB□5	1	1 unit	131	1.350
63	--	30	37	58	--	--	40	50	S2	B	3RW40 37-□BB□5	1	1 unit	131	1.350
72	--	37	45	62	--	--	40	60	S2	B	3RW40 38-□BB□5	1	1 unit	131	1.350
• With screw-type or spring-loaded terminals															
80	--	45	55	73	--	--	50	60	S3	B	3RW40 46-□BB□5	1	1 unit	131	1.900
106	--	55	75	98	--	--	75	75	S3	B	3RW40 47-□BB□5	1	1 unit	131	1.900

## Order No. supplement for connection types

- With screw terminals
- With spring-loaded terminals<sup>3)</sup>

Order No. supplement for rated control supply voltage  $U_c$ 

- 24 V AC/DC
- 110 ... 230 V AC/DC

1) Stand-alone installation without auxiliary fan.

2) Soft starter with screw terminals: delivery time class ▶ (preferred type).

3) Main circuit connection: screw terminals.

## Note:

Selection of the soft starter depends on the rated motor current.

The SIRIUS 3RW40 solid-state soft starters are designed for easy starting conditions.  $J_{Load} < 10 \times J_{Motor}$ . In the event of deviating conditions or increased switching frequency, it may be necessary to choose a larger device. Siemens recommends the use of the selection and simulation program Win-Soft Starter. For information about rated currents for ambient temperatures  $> 40$  °C, see technical specifications.

# 3RW Soft Starters

## 3RW40 for standard applications



3RW40 28-1TB04



3RW40 38-1TB04



3RW40 47-1TB04

Ambient temperature 40 °C				Ambient temperature 50 °C				Size	DT	Order No.	Price per PU	PU (UNIT, SET, M)	PS*	PG	Weight per PU approx. kg	
Rated operational current $I_e^{1)}$	Rated power of three-phase induction motors for rated operational voltage $U_e$			Rated operational current $I_e^{1)}$	Rated power of three-phase induction motors for rated operational voltage $U_e$											
	230 V	400 V	500 V		200 V	230 V	460 V	575 V								
A	kW	kW	kW	A	hp	hp	hp	hp								
<b>Rated operational voltage <math>U_e</math> 200 ... 480 V<sup>2)</sup>, with thermistor motor protection, rated control supply voltage <math>U_s</math> 24 V AC/DC</b>																
• With screw terminals																
12.5	3	<b>5.5</b>	--	11	3	3	<b>7.5</b>	--	<b>S0</b>	▶	<b>3RW40 24-1TB04</b>		1	1 unit	131	0.770
25	5.5	<b>11</b>	--	23	5	5	<b>15</b>	--	<b>S0</b>	▶	<b>3RW40 26-1TB04</b>		1	1 unit	131	0.770
32	7.5	<b>15</b>	--	29	7.5	7.5	<b>20</b>	--	<b>S0</b>	▶	<b>3RW40 27-1TB04</b>		1	1 unit	131	0.770
38	11	<b>18.5</b>	--	34	10	10	<b>25</b>	--	<b>S0</b>	▶	<b>3RW40 28-1TB04</b>		1	1 unit	131	0.770
• With spring-loaded terminals																
12.5	3	<b>5.5</b>	--	11	3	3	<b>7.5</b>	--	<b>S0</b>	B	<b>3RW40 24-2TB04</b>		1	1 unit	131	0.770
25	5.5	<b>11</b>	--	23	5	5	<b>15</b>	--	<b>S0</b>	B	<b>3RW40 26-2TB04</b>		1	1 unit	131	0.770
32	7.5	<b>15</b>	--	29	7.5	7.5	<b>20</b>	--	<b>S0</b>	B	<b>3RW40 27-2TB04</b>		1	1 unit	131	0.770
38	11	<b>18.5</b>	--	34	10	10	<b>25</b>	--	<b>S0</b>	B	<b>3RW40 28-2TB04</b>		1	1 unit	131	0.770
• With screw-type or spring-loaded terminals																
45	11	<b>22</b>	--	42	10	15	<b>30</b>	--	<b>S2</b>	B	<b>3RW40 36-□TB04</b>		1	1 unit	131	1.350
63	18.5	<b>30</b>	--	58	15	20	<b>40</b>	--	<b>S2</b>	B	<b>3RW40 37-□TB04</b>		1	1 unit	131	1.350
72	22	<b>37</b>	--	62	20	20	<b>40</b>	--	<b>S2</b>	B	<b>3RW40 38-□TB04</b>		1	1 unit	131	1.350
• With screw-type or spring-loaded terminals																
80	22	<b>45</b>	--	73	20	25	<b>50</b>	--	<b>S3</b>	B	<b>3RW40 46-□TB04</b>		1	1 unit	131	1.900
106	30	<b>55</b>	--	98	30	30	<b>75</b>	--	<b>S3</b>	B	<b>3RW40 47-□TB04</b>		1	1 unit	131	1.900
<b>Rated operational voltage <math>U_e</math> 400 ... 600 V, with thermistor motor protection, rated control supply voltage <math>U_s</math> 24 V AC/DC</b>																
• With screw terminals																
12.5	--	5.5	<b>7.5</b>	11	--	--	7.5	<b>10</b>	<b>S0</b>	B	<b>3RW40 24-1TB05</b>		1	1 unit	131	0.770
25	--	11	<b>15</b>	23	--	--	15	<b>20</b>	<b>S0</b>	B	<b>3RW40 26-1TB05</b>		1	1 unit	131	0.770
32	--	15	<b>18.5</b>	29	--	--	20	<b>25</b>	<b>S0</b>	B	<b>3RW40 27-1TB05</b>		1	1 unit	131	0.770
38	--	18.5	<b>22</b>	34	--	--	25	<b>30</b>	<b>S0</b>	B	<b>3RW40 28-1TB05</b>		1	1 unit	131	0.770
• With spring-loaded terminals																
12.5	--	5.5	<b>7.5</b>	11	--	--	7.5	<b>10</b>	<b>S0</b>	B	<b>3RW40 24-2TB05</b>		1	1 unit	131	0.770
25	--	11	<b>15</b>	23	--	--	15	<b>20</b>	<b>S0</b>	B	<b>3RW40 26-2TB05</b>		1	1 unit	131	0.770
32	--	15	<b>18.5</b>	29	--	--	20	<b>25</b>	<b>S0</b>	B	<b>3RW40 27-2TB05</b>		1	1 unit	131	0.770
38	--	18.5	<b>22</b>	34	--	--	25	<b>30</b>	<b>S0</b>	B	<b>3RW40 28-2TB05</b>		1	1 unit	131	0.770
• With screw-type or spring-loaded terminals																
45	--	22	<b>30</b>	42	--	--	30	<b>40</b>	<b>S2</b>	B	<b>3RW40 36-□TB05</b>		1	1 unit	131	1.350
63	--	30	<b>37</b>	58	--	--	40	<b>50</b>	<b>S2</b>	B	<b>3RW40 37-□TB05</b>		1	1 unit	131	1.350
72	--	37	<b>45</b>	62	--	--	40	<b>60</b>	<b>S2</b>	B	<b>3RW40 38-□TB05</b>		1	1 unit	131	1.350
• With screw-type or spring-loaded terminals																
80	--	45	<b>55</b>	73	--	--	50	<b>60</b>	<b>S3</b>	B	<b>3RW40 46-□TB05</b>		1	1 unit	131	1.900
106	--	55	<b>75</b>	98	--	--	75	<b>75</b>	<b>S3</b>	B	<b>3RW40 47-□TB05</b>		1	1 unit	131	1.900

### Order No. supplement for connection types

- With screw terminals
- With spring-loaded terminals<sup>3)</sup>

1) Stand-alone installation without auxiliary fan.

2) Soft starter with screw terminals: delivery time class ▶ (preferred type).

3) Main circuit connection: screw terminals.

1  
2

### Note:

Selection of the soft starter depends on the rated motor current.

The SIRIUS 3RW40 solid-state soft starters are designed for easy starting conditions.  $J_{Load} < 10 \times J_{Motor}$ . In the event of deviating conditions or increased switching frequency, it may be necessary to choose a larger device. Siemens recommends the use of the selection and simulation program Win-Soft Starter. For information about rated currents for ambient temperatures > 40 °C, see technical specifications.

\* You can order this quantity or a multiple thereof.

3RW40  
for standard applications

3RW40 56-6BB44



3RW40 76-6BB44

Ambient temperature 40 °C				Ambient temperature 50 °C				Size	DT	Order No.	Price per PU	PU (UNIT, SET, M)	PS*	PG	Weight per PU approx.
Rated operational current $I_e^{1)}$	Rated power of three-phase induction motors for rated operational voltage $U_e$			Rated operational current $I_e^{1)}$	Rated power of three-phase induction motors for rated operational voltage $U_e$										
	230 V	400 V	500 V		200 V	230 V	460 V	575 V							
A	kW	kW	kW	A	hp	hp	hp	hp						kg	
<b>Rated operational voltage <math>U_e</math> 200 ... 460 V<sup>2)</sup></b>															
• With screw-type or spring-loaded terminals															
134	37	<b>75</b>	--	117	30	40	<b>75</b>	--	<b>S6</b>	B	<b>3RW40 55-□BB□4</b>	1	1 unit	131	4.900
162	45	<b>90</b>	--	145	40	50	<b>100</b>	--		B	<b>3RW40 56-□BB□4</b>	1	1 unit	131	6.900
• With screw-type or spring-loaded terminals															
230	75	<b>132</b>	--	205	60	75	<b>150</b>	--	<b>S12</b>	B	<b>3RW40 73-□BB□4</b>	1	1 unit	131	8.900
280	90	<b>160</b>	--	248	75	100	<b>200</b>	--		B	<b>3RW40 74-□BB□4</b>	1	1 unit	131	8.900
356	110	<b>200</b>	--	315	100	125	<b>250</b>	--		B	<b>3RW40 75-□BB□4</b>	1	1 unit	131	8.900
432	132	<b>250</b>	--	385	125	150	<b>300</b>	--		B	<b>3RW40 76-□BB□4</b>	1	1 unit	131	8.900
<b>Rated operational voltage <math>U_e</math> 400 ... 600 V<sup>3)</sup></b>															
• With screw-type or spring-loaded terminals															
134	--	75	<b>90</b>	117	--	--	75	<b>100</b>	<b>S6</b>	B	<b>3RW40 55-□BB□5</b>	1	1 unit	131	4.900
162	--	90	<b>110</b>	145	--	--	100	<b>150</b>		B	<b>3RW40 56-□BB□5</b>	1	1 unit	131	6.900
• With screw-type or spring-loaded terminals															
230	--	132	<b>160</b>	205	--	--	150	<b>200</b>	<b>S12</b>	B	<b>3RW40 73-□BB□5</b>	1	1 unit	131	8.900
280	--	160	<b>200</b>	248	--	--	200	<b>250</b>		B	<b>3RW40 74-□BB□5</b>	1	1 unit	131	8.900
356	--	200	<b>250</b>	315	--	--	250	<b>300</b>		B	<b>3RW40 75-□BB□5</b>	1	1 unit	131	8.900
432	--	250	<b>315</b>	385	--	--	300	<b>400</b>		B	<b>3RW40 76-□BB□5</b>	1	1 unit	131	8.900
<b>Order No. supplement for connection types<sup>4)</sup></b>															
• With screw terminals															
• With spring-loaded terminals															
<b>Order No. supplement for the rated control supply voltage <math>U_s</math><sup>5)</sup></b>															
• 115 V AC															
• 230 V AC															

1) Stand-alone installation.

2) Soft starter with screw terminals: delivery time class ▶ (preferred type).

3) Soft starter with screw terminals: delivery time class A.

4) Main circuit connection: busbar connection.

5) Control by way of the internal 24 V DC supply and direct control by means of PLC possible.

**Note:**

Selection of the soft starter depends on the rated motor current.







The SIRIUS 3RW40 solid-state soft starters are designed for easy starting conditions.  $J_{Load} < 10 \times J_{Motor}$ . In the event of deviating conditions or increased switching frequency, it may be necessary to choose a larger device. Siemens recommends the use of the selection and simulation program Win-Soft Starter. For information about rated currents for ambient temperatures > 40 °C, see technical specifications.



# 3RW Soft Starters

## 3RW40 for standard applications

### Accessories

For soft starters		Version	DT	Order No.	Price per PU	PU (UNIT, SET, M)	PS*	PG	Weight per PU approx. kg
Type	Size								
<b>Box terminal blocks for soft starters</b>									
<b>For round and ribbon cables</b>									
	3RW40 5.	<b>S6</b>	<ul style="list-style-type: none"> <li>Up to 70 mm<sup>2</sup></li> <li>Up to 120 mm<sup>2</sup></li> </ul>	▶	<b>3RT19 55-4G</b>	1	1 unit	101	0.230
	3RW40 7.	<b>S12</b>	<ul style="list-style-type: none"> <li>Up to 240 mm<sup>2</sup></li> </ul>	▶	<b>3RT19 56-4G</b>	1	1 unit	101	0.260
				▶	<b>3RT19 66-4G</b>	1	1 unit	101	0.676
<b>Auxiliary terminals</b>									
<b>Auxiliary terminals, 3-pole</b>									
	3RW40 4.	<b>S3</b>		B	<b>3RT19 46-4F</b>	1	1 unit	101	0.035
<b>Covers for soft starters</b>									
<b>Terminal covers for box terminals</b>									
Additional touch protection to be fitted at the box terminals (2 units required per device)									
	3RW40 3.	<b>S2</b>		▶	<b>3RT19 36-4EA2</b>	1	1 unit	101	0.020
	3RW40 4.	<b>S3</b>		▶	<b>3RT19 46-4EA2</b>	1	1 unit	101	0.025
	3RW40 5.	<b>S6</b>		▶	<b>3RT19 56-4EA2</b>	1	1 unit	101	0.030
	3RW40 7.	<b>S12</b>		▶	<b>3RT19 66-4EA2</b>	1	1 unit	101	0.040
<b>Terminal covers for cable lugs and busbar connections</b>									
	3RW40 4.	<b>S3</b>	For complying with the phase clearances and as touch protection if box terminal is removed	▶	<b>3RT19 46-4EA1</b>	1	1 unit	101	0.040
	3RW40 5.	<b>S6</b>		▶	<b>3RT19 56-4EA1</b>	1	1 unit	101	0.070
	3RW40 7.	<b>S12</b>	(2 units required per contactor)	▶	<b>3RT19 66-4EA1</b>	1	1 unit	101	0.130
<b>Sealing covers</b>									
	3RW40 2. to 3RW40 4.	<b>S0, S2, S3</b>		▶	<b>3RW49 00-0PB10</b>	1	1 unit	131	0.005
	3RW40 5. and 3RW40 7.	<b>S6, S12</b>		▶	<b>3RW49 00-0PB00</b>	1	1 unit	131	0.010
<b>Modules for RESET<sup>1)</sup></b>									
<b>Modules for remote RESET, electrical</b>									
Operating range 0.85 ... 1.1 x U <sub>s</sub> , power consumption AC 80 VA, DC 70 W, ON period 0.2 s ... 4 s, switching frequency 60/h									
	3RW40 5. and 3RW40 7.	<b>S6, S12</b>	<ul style="list-style-type: none"> <li>24 ... 30 V AC/DC</li> <li>110 ... 127 V AC/DC</li> <li>220 ... 250 V AC/DC</li> </ul>	▶	<b>3RU19 00-2AB71</b>	1	1 unit	101	0.066
				▶	<b>3RU19 00-2AF71</b>	1	1 unit	101	0.067
				▶	<b>3RU19 00-2AM71</b>	1	1 unit	101	0.066
<b>Mechanical RESET comprising</b>									
	3RW40 5. and 3RW40 7.	<b>S6, S12</b>	<ul style="list-style-type: none"> <li>Resetting plunger, holder and former</li> <li>Suitable pushbutton IP65, Ø 22 mm, 12 mm stroke</li> <li>Extension plunger</li> </ul>	▶	<b>3RU19 00-1A</b>	1	1 unit	101	0.038
				B	<b>3SB30 00-0EA11</b>	1	1 unit	102	0.020
				A	<b>3SX13 35</b>	1	1 unit	102	0.004
<b>Cable releases with holder for RESET</b>									
For Ø 6.5 mm holes in the control panel; max. control panel thickness 8 mm									
	3RW40 5. and 3RW40 7.	<b>S6, S12</b>	<ul style="list-style-type: none"> <li>Length 400 mm</li> <li>Length 600 mm</li> </ul>	▶	<b>3RU19 00-1B</b>	1	1 unit	101	0.063
				▶	<b>3RU19 00-1C</b>	1	1 unit	101	0.073

<sup>1)</sup> Remote RESET already integrated in the soft starters 3RW40 2. to 3RW40 4..

**3RW40**  
 for standard applications

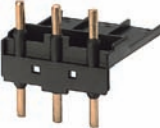
For soft starters		Motor starter protectors		DT	Order No.	Price per PU	PU (UNIT, SET, M)	PS*	PG	Weight per PU approx. kg
Type	Size	Type	Size							
<b>Link modules to motor starter protectors</b>										
	3RW40 24, 3RW40 26	<b>S0</b>	<b>S0</b>	▶	<b>3RA19 21-1A</b>		1	10 units	101	0.028
	3RW40 27, 3RW40 28		<b>S2</b>	D	<b>3RA19 31-1D</b>		1	5 units	101	0.041
	3RW40 36	<b>S2</b>	<b>S2</b>	▶	<b>3RA19 31-1A</b>		1	5 units	101	0.033
	3RW40 37, 3RW40 38		<b>S3</b>	D	<b>3RA19 41-1D</b>		1	5 units	101	0.042
	3RW40 46, 3RW40 47	<b>S3</b>	<b>S3</b>	▶	<b>3RA19 41-1A</b>		1	5 units	101	0.072

**Fans (to increase switching frequency and for device mounting in positions different from the normal position)**

	3RW40 2.	<b>S0</b>		▶	<b>3RW49 28-8VB00</b>		1	1 unit	131	0.010
	3RW40 3., 3RW40 4.	<b>S2,</b> <b>S3</b>		▶	<b>3RW49 47-8VB00</b>		1	1 unit	131	0.020

**Operating instructions<sup>1)</sup>**

For soft starters

 3RW40 2. **S0**  
 3RW40 3. **S2**  
 3RW40 4. **S3**  
 3RW40 5. **S6**  
 3RW40 7. **S12**
**3ZX10 12-0RW40-1AA1****3ZX10 12-0RW40-2DA1**
<sup>1)</sup> The operating instructions are included in the scope of supply.

**Spare parts**

For soft starters		Version		DT	Order No.	Price per PU	PU (UNIT, SET, M)	PS*	PG	Weight per PU approx. kg
Type	Size	Rated control supply voltage $U_s$								
<b>Fans</b>										
	3RW40 5.-.BB3.	<b>S6</b>	115 V AC	▶	<b>3RW49 36-8VX30</b>		1	1 unit	131	0.300
	3RW40 5.-.BB4.	<b>S6</b>	230 V AC	▶	<b>3RW49 36-8VX40</b>		1	1 unit	131	0.300
	3RW40 7.-.BB3.	<b>S12</b>	115 V AC	▶	<b>3RW49 47-8VX30</b>		1	1 unit	131	0.500
	3RW40 7.-.BB4.	<b>S12</b>	230 V AC	▶	<b>3RW49 47-8VX40</b>		1	1 unit	131	0.500

# 3RW Soft Starters

## 3RW30 for standard applications

### Function

The space required by the compact SIRIUS 3RW30 soft starter is often only about one third of that required by a wye-delta assembly of comparable rating. This not only saves space in the control cabinet and on the standard mounting rail but also does away completely with the wiring work needed for wye-delta starters. This is notable in particular for higher motor ratings which are only rarely available as fully wired solutions.

At the same time the number of cables from the starter to the motor is reduced from six to three. Compact dimensions, short start-up times, easy wiring and fast commissioning make themselves felt as clear-cut cost advantages.

The bypass contacts of these soft starters are protected during operation by an integrated solid-state arc quenching system. This prevents damage to the bypass contacts in the event of a fault, e.g. brief disconnection of the control voltage, mechanical shocks or life-related component defects on the coil operating mechanism or main contact spring.

The new series of devices comes with the "polarity balancing" control method, which is designed to prevent direct current components in two-phase controlled soft starters. On two-phase controlled soft starters the current resulting from superimposition of the two controlled phases flows in the uncontrolled phase. This results for physical reasons in an asymmetric distribution of the three phase currents during the motor ramp-up. This phenomenon cannot be influenced, but in most applications it is non-critical.

Controlling the power semiconductors results not only in this asymmetry, however, but also in the previously mentioned direct current components which can cause severe noise generation on the motor at starting voltages of less than 50 %. The control method used for these soft starters eliminates these direct current components during the ramp-up phase and prevents the braking torque which they can cause.

It creates a motor ramp-up that is uniform in speed, torque and current rise, thus permitting a particularly gentle, two-phase starting of the motors. At the same time the acoustic quality of the starting operation comes close to the quality of a three-phase controlled soft starter. This is made possible by the on-going dynamic harmonizing and balancing of current half-waves of different polarity during the motor ramp-up. Hence the name "polarity balancing".

- Soft starting with voltage ramp; the starting voltage setting range  $U_s$  is 40 % to 100 % and the ramp time  $t_R$  can be set from 0 s to 20 s.
- Integrated bypass contact system to minimize power loss
- Setting with two potentiometers
- Simple mounting and start-up
- Mains voltages at 50/60 Hz, 200 to 480 V
- Two control voltage versions 24 V AC/DC and 110 to 230 V AC/DC
- Wide temperature range from -25 °C to +60 °C
- The built-in auxiliary contact ensures user-friendly control and possible further processing within the system ([for status graphs see page 6/22](#)).

### Technical specifications

Type	3RW30 1., 3RW30 2.		3RW30 3., 3RW30 4.			
<b>Control electronics</b>						
<b>Rated values</b>	Terminal A1/A2	V	24	110 ... 230	24	110 ... 230
Rated control supply voltage		%	±20	-15/+10	±20	-15/+10
• Tolerance						
Rated control supply current		mA	< 50	6	20	< 50
• STANDBY		mA	< 100	15	< 4000	< 500
• During pick-up		mA	< 100	15	20	< 50
• ON						
Rated frequency		Hz	50/60			
• Tolerance		%	±10			
<b>Control input</b>						
IN			ON/OFF			
Power consumption with version		mA	approx. 12			
• 24 V DC		mA	AC: 3/6; DC: 1.5/3			
• 110/230 V AC						
<b>Relay outputs</b>						
Output 1	ON	13/14	Operating indication (NO)			
Rated operational current		A	3 AC-15/AC-14 at 230 V, 1 DC-13 at 24 V			
Protection against overvoltages			Protection by means of varistor through contact			
Short-circuit protection			4 A gL/gG operational class; 6 A quick (fuse is not included in scope of supply)			
<b>Operating indications</b>						
		LED	<b>DEVICE</b>	<b>STATE/BYPASSED/FAILURE</b>	<b>DEVICE</b>	<b>STATE/BYPASSED/FAILURE</b>
Off			Green	Off	Green	Off
Start			Green	Green flashing	Green	Green flashing
Bypass			Green	Green	Green	Green
<b>Error signals</b>						
• 24 V DC: $U < 0.75 \times U_s$ or $U > 1.25 \times U_s$			Off	Red	Off	Red
• 110 ... 230 V AC: $U < 0.75 \times U_s$ or $U > 1.15 \times U_s$			Off	Red	Off	Red
Electrical overloading of bypass (reset by removing IN command)			Yellow	Red	--	--
Missing mains voltage, phase failure, missing load			Green	Red	Green	Red
Device fault			Red	Red	Red	Red

Type	3RW30 1. ... 3RW30 4.		
			Factory default
<b>Control times and parameters</b>			
<b>Control times</b>			
Closing delay (with connected control voltage)	ms	< 50	
Closing delay (automatic/mains contactor mode)	ms	< 300	
<b>Mains failure bridging time</b>			
Control supply voltage	ms	50	
<b>Mains failure response time<sup>1)</sup></b>			
Load current circuit	ms	500	
<b>Starting parameters</b>			
• Starting time	s	0 ... 20	7.5
• Starting voltage	%	40 ... 100	40
<b>Start-up detection</b>			
No			
<b>Operating mode output 13/14</b>			
Rising edge at	Start command	ON	
Falling edge at	Off command		

<sup>1)</sup> Mains failure detection only in standby state, not during operation.

Type	3RW30 1.-.BB.4 ... 3RW30 4.-.BB.4		
<b>Power electronics</b>			
<b>Rated operational voltage</b>			
Tolerance	V AC	200 ... 480	
	%	-15/+10	
<b>Rated frequency</b>			
Tolerance	Hz	50/60	
	%	±10	
<b>Continuous duty at 40 °C (% of <math>I_e</math>)</b>			
	%	115	
<b>Minimum load (% of <math>I_e</math>)</b>			
	%	10 (at least 2 A)	
<b>Maximum cable length between soft starter and motor</b>			
	m	300	
<b>Permissible installation height</b>			
	m	5000	(derating from 1000, see characteristic curves); higher on request
<b>Permissible mounting position</b> (auxiliary fan not available)			
<b>Permissible ambient temperature</b>			
Operation	°C	-25 ... +60; (derating from +40)	
Storage	°C	-40 ... +80	
<b>Degree of protection</b>			
		IP20 for 3RW30 1. and 3RW30 2.; IP00 for 3RW30 3. and 3RW30 4.	

Type	3RW30 13	3RW30 14	3RW30 16	3RW30 17	3RW30 18	
<b>Power electronics</b>						
<b>Load rating with rated operational current <math>I_e</math></b>						
• According to IEC and UL/CSA <sup>1)</sup> , for individual mounting, AC-53a						
- at 40 °C	A	3.6	6.5	9	12.5	17.6
- at 50 °C	A	3.3	6	8	12	17
- at 60 °C	A	3	5.5	7	11	14
<b>Power loss</b>						
• In operation after completed ramp-up with uninterrupted rated operational current (40 °C) approx.						
	W	0.25	0.5	1	2	4
• During starting with 300 % $I_M$ (40°C)						
	W	6	13	20	20	29
<b>Permissible rated motor current and starts per hour for normal starting (Class 10)</b>						
- rated motor current $I_M^{(2)}$ , starting time 3 s	A	3.6	6.5	9	12.5	17.6
- starts per hour <sup>3)</sup>	1/h	200	87	50	85	62
- rated motor current $I_M^{(2)}$ , starting time 4 s	A	3.6	6.5	9	12.5	17.6
- starts per hour <sup>3)</sup>	1/h	150	64	35	62	45

<sup>1)</sup> Measurement at 60 °C according to UL/CSA not required.

<sup>2)</sup> With 300 %  $I_M$ .

<sup>3)</sup> For intermittent duty S4 with ON period = 30 %,  $T_U = 40$  °C, stand-alone installation vertical. The quoted switching frequencies do not apply for automatic mode.

# 3RW Soft Starters

## 3RW30 for standard applications

Type		3RW30 26	3RW30 27	3RW30 28
<b>Power electronics</b>				
<b>Load rating with rated operational current <math>I_e</math></b>				
• According to IEC and UL/CSA <sup>1)</sup> , for individual mounting, AC-53a				
- at 40 °C	A	25.3	32.2	38
- at 50 °C	A	23	29	34
- at 60 °C	A	21	26	31
<b>Power loss</b>				
• In operation after completed ramp-up with uninterrupted rated operational current (40 °C) approx.				
	W	8	13	19
• During starting with 300 % $I_M$ (40°C)				
	W	47	55	64
<b>Permissible rated motor current and starts per hour for normal starting (Class 10)</b>				
- rated motor current $I_M^{(2)}$ , starting time 3 s				
	A	25	32	38
- starts per hour <sup>3)</sup>	1/h	23	23	19
- rated motor current $I_M^{(2)}$ , starting time 4 s				
	A	25	32	38
- starts per hour <sup>3)</sup>	1/h	15	16	12

1) Measurement at 60 °C according to UL/CSA not required.

2) With 300 %  $I_M$ .



3) For intermittent duty S4 with ON period = 30 %,  $T_U = 40$  °C, stand-alone installation vertical. The quoted switching frequencies do not apply for automatic mode.

Type		3RW30 36	3RW30 37	3RW30 38	3RW30 46	3RW30 47
<b>Power electronics</b>						
<b>Load rating with rated operational current <math>I_e</math></b>						
• According to IEC and UL/CSA <sup>1)</sup> , for individual mounting, AC-53a						
- at 40 °C	A	45	65	72	80	106
- at 50 °C	A	42	58	62.1	73	98
- at 60 °C	A	39	53	60	66	90
<b>Power loss</b>						
• In operation after completed ramp-up with uninterrupted rated operational current (40 °C) approx.						
	W	6	12	15	12	21
• During starting with 300 % $I_M$ (40°C)						
	W	79	111	125	144	192
<b>Permissible rated motor current and starts per hour for normal starting (Class 10)</b>						
- rated motor current $I_M^{(2)}$ , starting time 3 s						
	A	45	63	72	80	106
- starts per hour <sup>3)</sup>	1/h	38	23	22	22	15
- rated motor current $I_M^{(2)}$ , starting time 4 s						
	A	45	63	72	80	106
- starts per hour <sup>3)</sup>	1/h	26	15	15	15	10

1) Measurement at 60 °C according to UL/CSA not required.

2) With 300 %  $I_M$ .

3) For intermittent duty S4 with ON period = 70 %,  $T_U = 40$  °C, stand-alone installation vertical. The quoted switching frequencies do not apply for automatic mode.

Soft starters	Type	3RW30 1.	3RW30 2.	3RW30 3.	3RW30 4.	
<b>Conductor cross-sections</b>						
<b>Screw terminals</b>	<b>Main conductors</b>					
<b>Front clamping point connected</b> 	• Solid	mm <sup>2</sup>	2 x (1 ... 2.5); 2 x (2.5 ... 6) acc. to IEC 60947	2 x (1 ... 2.5); 2 x (2.5 ... 6) acc. to IEC 60947; max. 1 x 10	2 x (1.5 ... 16)	2 x (2.5 ... 16)
	• Finely stranded with end sleeve	mm <sup>2</sup>	2 x (1.5 ... 2.5); 2 x (2.5 ... 6)	2 x (1 ... 2.5); 2 x (2.5 ... 6)	1 x (0.75 ... 25)	1 x (2.5 ... 35)
	• Stranded	mm <sup>2</sup>	--	--	1 x (0.75 ... 35)	1 x (4 ... 70)
<b>Rear clamping point connected</b> 	• AWG cables - solid or stranded - stranded	AWG AWG	2 x (14 ... 10) 1 x 8	2 x (14 ... 10) 1 x 8	1 x (18 ... 2) --	1 x (10 ... 2/0) --
	• Solid	mm <sup>2</sup>	--	--	2 x (1.5 ... 16)	2 x (2.5 ... 16)
	• Finely stranded with end sleeve	mm <sup>2</sup>	--	--	1 x (1.5 ... 25)	1 x (2.5 ... 50)
<b>Both clamping points connected</b> 	• Stranded	mm <sup>2</sup>	--	--	1 x (1.5 ... 35)	1 x (10 ... 70)
	• AWG cables - solid or stranded	AWG	--	--	1 x (16 ... 2)	1 x (10 ... 2/0)
	• Solid	mm <sup>2</sup>	--	--	2 x (1.5 ... 16)	2 x (2.5 ... 16)
	• Stranded	mm <sup>2</sup>	--	--	2 x (1.5 ... 25)	2 x (10 ... 50)
	• Finely stranded with end sleeve	mm <sup>2</sup>	--	--	2 x (1.5 ... 16)	2 x (2.5 ... 35)
	• AWG cables - solid or stranded	AWG	--	--	2 x (16 ... 2)	2 x (10 ... 1/0)
	• Tightening torque	Nm lb.in	2 ... 2.5 18 ... 22	2 ... 2.5 18 ... 22	4.5 40	6.5 58
	Tools		PZ 2	PZ 2	PZ 2	Allen screw 4 mm
	Degree of protection		IP20	IP20	IP20 (IP00 terminal compartment)	IP20 (IP00 terminal compartment)
<b>Spring-loaded terminals</b>	<b>Main conductors</b>					
	• Solid	mm <sup>2</sup>	1 ... 4	1 ... 10	--	--
	• Finely stranded with end sleeve	mm <sup>2</sup>	1 ... 2.5	1 ... 6, end sleeves without plastic collar	--	--
	• AWG cables - solid or stranded (finely stranded) - stranded	AWG AWG	16 ... 14 16 ... 12	16 ... 10 1 x 8	-- --	-- --
	Tools		DIN ISO 2380-1A0; 5 x 3	DIN ISO 2380-1A0; 5 x 3	--	--
	Degree of protection		IP20	IP20	--	--
<b>Busbar connections</b>	<b>Main conductors</b>					
	• With cable lug according to DIN 46234 or max. 20 mm wide - stranded	mm <sup>2</sup>	--	--	--	2 x (10 ... 70)
	- finely stranded	mm <sup>2</sup>	--	--	--	2 x (10 ... 50)
	• AWG cables, solid or stranded	AWG	--	--	--	2 x (7 ... 1/0)

Soft starters	Type	3RW30 1. ... 3RW30 4.
<b>Conductor cross-sections</b>		
<b>Auxiliary conductors</b> (1 or 2 conductors can be connected):		
<b>Screw terminals</b>		
• Solid	mm <sup>2</sup>	2 x (0.5 ... 2.5)
• Finely stranded with end sleeve	mm <sup>2</sup>	2 x (0.5 ... 1.5)
• AWG cables - solid or stranded - finely stranded with end sleeve	AWG AWG	2 x (20 ... 14) 2 x (20 ... 16)
• Terminal screws - tightening torque	Nm lb.in	0.8 ... 1.2 7 ... 10.3
<b>Spring-loaded terminals</b>		
• Solid	mm <sup>2</sup>	2 x (0.25 ... 2.5)
• Finely stranded with end sleeve	mm <sup>2</sup>	2 x (0.25 ... 1.5)
• AWG cables, solid or stranded	AWG	2 x (24 ... 14)

# 3RW Soft Starters

## 3RW30 for standard applications

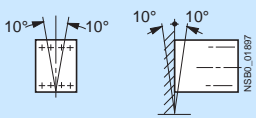
Type	3RW30 03	
<b>Control electronics</b>		
<b>Rated values</b>		
Rated control supply voltage	V	24 ... 230 AC/DC
• Tolerance	%	± 10
Rated control supply current	mA	25 ... 4
Rated frequency at AC	Hz	50/60
• Tolerance	%	± 10
<b>Starting time</b>	s	0.1 ... 20 (adjustable)
<b>Starting voltage</b>	%	40 ... 100 (adjustable)
<b>Ramp-down time</b>	s	0 ... 20 (adjustable)
<b>Power electronics</b>		
<b>Rated operational voltage</b>	V AC	200 ... 400
Tolerance	%	± 10
<b>Rated frequency</b>	Hz	50/60
Tolerance	%	± 10
<b>Continuous duty</b> (% of $I_e$ )	%	100
<b>Minimum load<sup>1)</sup></b> (% of $I_e$ ); at 40 °C	%	9
<b>Maximum conductor length</b> between soft starter and motor	m	100 <sup>2)</sup>
<b>Degree of protection</b> according to IEC 60529		IP20 (IP00 terminal compartment)
<b>Permissible installation height</b>	m	5000 (derating from 1000, see characteristic curves); higher on request
<b>Permissible mounting position</b>		
<b>Permissible ambient temperature</b>		
Operation	°C	-25 ... +60; (derating from +40)
Storage	°C	-40 ... +80
<b>Load rating with rated operational current <math>I_e</math></b>		
• According to IEC and UL/CSA <sup>1)</sup> , for individual mounting, AC-53a		
- at 40 °C	A	3
- at 50 °C	A	2.6
- at 60 °C	A	2.2
• According to IEC and UL/CSA <sup>1)</sup> , for butt-mounting, AC-53a		
- at 40 °C	A	2.6
- at 50 °C	A	2.2
- at 60 °C	A	1.8
<b>Power loss</b>		
• In operation after completed ramp-up with uninterrupted rated operational current (40 °C) approx.	W	6.5
• At utilization of max. switching frequency	W	3
<b>Permissible starts per hour</b>		
• For intermittent duty S4, $T_u = 40$ °C, stand-alone installation vertical	1/h	1500
• ON period = 70 %	% $I_e$ /s	300/0.2
<b>Conductor cross-sections</b>		
<b>Screw terminals</b> (1 or 2 conductors connectable) For standard screwdriver size 2 and Pozidriv 2		
• <b>Main conductors</b>		
- solid	mm <sup>2</sup>	1 x (0.5 ... 4); 2 x (0.5 ... 2.5)
- finely stranded with end sleeve	mm <sup>2</sup>	1 x (0.5 ... 2.5); 2 x (0.5 ... 1.5)
- stranded	mm <sup>2</sup>	--
- AWG cables, solid or stranded	AWG	2 x (20 ... 14)
- terminal screws		M3, PZ2
- tightening torque	Nm lb.in	0.8 ... 1.2 7.1 ... 8.9
• <b>Auxiliary conductors</b>		
- solid	mm <sup>2</sup>	1 x (0.5 ... 4); 2 x (0.5 ... 2.5)
- finely stranded with end sleeve	mm <sup>2</sup>	1 x (0.5 ... 2.5); 2 x (0.5 ... 1.5)
- AWG cables, solid or stranded	AWG	2 x (20 ... 14)
- terminal screws		M3, PZ2
- tightening torque	Nm lb.in	0.8 ... 1.2 7 ... 8.9
<b>Spring-loaded terminals</b>	<b>Main and auxiliary conductors</b>	
	• Solid	mm <sup>2</sup> 2 x (0.25 ... 1.5)
	• Finely stranded with end sleeve	mm <sup>2</sup> 2 x (0.25 ... 1)
	• AWG cables, solid or stranded	mm <sup>2</sup> 2 x (24 ... 16)

<sup>1)</sup> The rated motor current (specified on the motor's name plate) should at least amount to the specified percentage of the SIRIUS soft starter unit's rated operational current  $I_e$ .

<sup>2)</sup> If this value is exceeded, problems with line capacities may arise, which can result in false firing.



	Standard	Parameters
<b>Electromagnetic compatibility according to EN 60947-4-2</b>		
<i>EMC interference immunity</i>		
<b>Electrostatic discharge (ESD)</b>	EN 61000-4-2	±4 kV contact discharge, ±8 kV air discharge
<b>Electromagnetic RF fields</b>	EN 61000-4-3	Frequency range: 80 ... 2000 MHz with 80 % at 1 kHz Degree of severity 3: 10 V/m
<b>Conducted RF interference</b>	EN 61000-4-6	Frequency range: 150 kHz ... 80 MHz with 80 % at 1 kHz Interference 10 V
<b>RF voltages and RF currents on cables</b>		
• Burst	EN 61000-4-4	±2 kV/5 kHz
• Surge	EN 61000-4-5	±1 kV line to line ±2 kV line to earth
<i>EMC interference emission</i>		
<b>EMC interference field strength</b>	EN 55011	Limit value of Class A at 30 ... 1000 MHz, limit value of Class B at 3RW30 2.; 24 V AC/DC
<b>Radio interference voltage</b>	EN 55011	Limit value of Class A at 0.15 ... 30 MHz, limit value of Class B for 3RW30 2.; 24 V AC/DC
<i>Radio interference suppression filters</i>		
<b>Degree of noise suppression A</b> (industrial applications)	Not required	
<b>Degree of noise suppression B</b> (applications for residential areas) Control voltage • 230 V AC/DC • 24 V AC/DC	Not available <sup>1)</sup> Not required for 3RW30 1. and 3RW30 2.; required for 3RW30 3. and 3RW30 4. (see table)	

<sup>1)</sup> Degree of noise suppression B cannot be obtained through the use of filters as the strength of the electromagnetic field is not attenuated by the filter.

Soft starter types	Rated current Soft starters A	Recommended filters <sup>1)</sup>		
		Voltage range 200 ... 480 V		
		Filter types	Rated current filters A	Terminals mm <sup>2</sup>
<b>3RW30 36</b>	45	4EF1512-1AA10	50	16
<b>3RW30 37</b>	63	4EF1512-2AA10	66	25
<b>3RW30 38</b>	72	4EF1512-3AA10	90	25
<b>3RW30 46</b>	80	4EF1512-3AA10	90	25
<b>3RW30 47</b>	106	4EF1512-4AA10	120	50

<sup>1)</sup> The radio interference suppression filter is used to remove the conducted interference from the main circuit. The field-related emissions comply with degree of noise suppression B.

# 3RW Soft Starters

## 3RW30 for standard applications

### Fuse assignment

The type of coordination to which the motor feeder with soft starter is mounted depends on the application-specific requirements. Normally, fuseless mounting (combination of motor starter protector and soft starter) is sufficient.

If type 2 coordination is to be fulfilled, semiconductor fuses must be fitted in the motor feeder.

#### Fuseless version

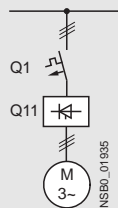

Soft starters		Motor starter protectors <sup>1)</sup>		
Q11 Type	Rated current A	Q1 Type	$I_{q \max}$ kA	Rated current A
<b>Type of coordination 1<sup>2)</sup></b>				
3RW30 03	3	3RV10 11-1EA10	50	4
3RW30 13	3.6	3RV10 21-1FA10	10	5
3RW30 14	6.5	3RV10 21-1HA10	10	8
3RW30 16	9	3RV10 21-1JA10	10	10
3RW30 17	12.5	3RV10 21-1KA10	10	12.5
3RW30 18	17.6	3RV10 21-1BA10	10	20
3RW30 26	25	3RV10 31-4DA10	55	25
3RW30 27	32	3RV10 31-4EA10	55	32
3RW30 28	38	3RV10 31-4FA10	55	40
3RW30 36	45	3RV10 31-4GA10	20	45
3RW30 37	63	3RV10 41-4JA10	20	63
3RW30 38	72	3RV10 41-4KA10	20	75
3RW30 46	80	3RV10 41-4LA10	11	90
3RW30 47	106	3RV10 41-4MA10	11	100

<sup>1)</sup> The rated motor current must be considered when selecting the devices.

<sup>2)</sup> The types of coordination are explained in more detail in Catalog LV 1, "Load Feeders, Motor Starters and Soft Starters" → "Fuseless Load Feeders".

#### Fused version (line protection only)

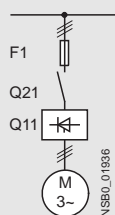

Soft starters		Line protection, maximum		Line contactors	
Q11 Type	Rated current A	F1 Type	Rated current A	Size	(optional) Q21
<b>Type of coordination 1<sup>1)</sup>: <math>I_q = 65 \text{ kA at } 480 \text{ V } 10 \%</math></b>					
3RW30 03 <sup>2)</sup>	3	3NA3 805 <sup>3)</sup>	20	000	3RT10 15
3RW30 13	3.6	3NA3 803-6	10	000	3RT10 15
3RW30 14	6.5	3NA3 805-6	16	000	3RT10 15
3RW30 16	9	3NA3 807-6	20	000	3RT10 16
3RW30 17	12.5	3NA3 810-6	25	000	3RT10 24
3RW30 18	17.6	3NA3 814-6	35	000	3RT10 26
3RW30 26	25	3NA3 822-6	63	00	3RT10 26
3RW30 27	32	3NA3 824-6	80	00	3RT10 34
3RW30 28	38	3NA3 824-6	80	00	3RT10 35
3RW30 36	45	3NA3 130-6	100	1	3RT10 36
3RW30 37	63	3NA3 132-6	125	1	3RT10 44
3RW30 38	72	3NA3 132-6	125	1	3RT10 45
3RW30 46	80	3NA3 136-6	160	1	3RT10 45
3RW30 47	106	3NA3 136-6	160	1	3RT10 46

<sup>1)</sup> The types of coordination are explained in more detail in Catalog LV 1, "Load Feeders, Motor Starters and Soft Starters" → "Fuseless Load Feeders".

<sup>3)</sup> 3NA3 805-1 (NH00), 5SB2 61 (DIAZED), 5SE2 201-6 (NEOZED).

<sup>2)</sup>  $I_q = 50 \text{ kA at } 400 \text{ V}$ .

## Fused version with 3NE1 SITOR fuses (semiconductor and line protection)

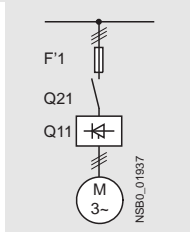

Soft starters		All-range fuses			Line contactors
Q11 Type	Rated current A	F'1 Type	Rated current A	Size	(optional) Q21
<b>Type of coordination 2<sup>1)</sup>: <math>I_q = 65 \text{ kA at } 480 \text{ V } 10 \%</math></b>					
<b>3RW30 03<sup>2)</sup></b>	3	3NE1 813-0 <sup>3)</sup>	16	000	3RT10 15
<b>3RW30 13</b>	3.6	3NE1 813-0	16	000	3RT10 15
<b>3RW30 14</b>	6.5	3NE1 813-0	16	000	3RT10 15
<b>3RW30 16</b>	9	3NE1 813-0	16	000	3RT10 16
<b>3RW30 17</b>	12.5	3NE1 813-0	16	000	3RT10 24
<b>3RW30 18</b>	17.6	3NE1 814-0	20	000	3RT10 26
<b>3RW30 26</b>	25	3NE1 803-0	35	000	3RT10 26
<b>3RW30 27</b>	32	3NE1 020-2	80	00	3RT10 34
<b>3RW30 28</b>	38	3NE1 020-2	80	00	3RT10 35
<b>3RW30 36</b>	45	3NE1 020-2	80	00	3RT10 36
<b>3RW30 37</b>	63	3NE1 820-0	80	000	3RT10 44
<b>3RW30 38</b>	72	3NE1 820-0	80	000	3RT10 45
<b>3RW30 46</b>	80	3NE1 021-0	100	00	3RT10 45
<b>3RW30 47</b>	106	3NE1 022-0	125	00	3RT10 46

<sup>1)</sup> The types of coordination are explained in more detail in Catalog LV 1, "Load Feeders, Motor Starters and Soft Starters" —> "Fuseless Load Feeders".

The type of coordination "2" refers only to soft starters, not to any components in the feeder.

<sup>2)</sup>  $I_q = 50 \text{ kA at } 400 \text{ V}$ .

<sup>3)</sup> No SITOR fuse required!  
Alternatively: 3NA3 803 (NH00), 5SB2 21 (DIAZED), 5SE2 206 (NEOZED).

# 3RW Soft Starters

## 3RW30 for standard applications

**Fused version with 3NE3 SITOR fuses** (semiconductor protection by fuse, line and overload protection by motor starter protector; alternatively, installation with contactor and overload relay possible)

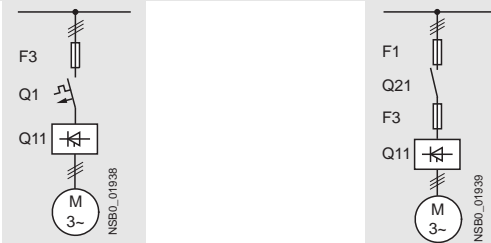

Soft starters		Semiconductor fuses, minimum			Semiconductor fuses, maximum			Semiconductor fuses, minimum		
Q11 Type	Rated current A	F3 Type	Rated current A	Size	F3 Type	Rated current A	Size	F3 Type	Rated current A	Size
<b>Type of coordination 2<sup>1)</sup>: I<sub>q</sub> = 65 kA at 480 V 10 %</b>										
3RW30 03 <sup>2)</sup>	3	--	--	--	--	--	--	--	--	--
3RW30 13	3.6	--	--	--	--	--	--	3NE4 101	32	0
3RW30 14	6.5	--	--	--	--	--	--	3NE4 101	32	0
3RW30 16	9	--	--	--	--	--	--	3NE4 101	32	0
3RW30 17	12.5	--	--	--	--	--	--	3NE4 101	32	0
3RW30 18	17.6	--	--	--	3NE3 221	100	1	3NE4 101	32	0
3RW30 26	25	--	--	--	3NE3 221	100	1	3NE4 102	40	0
3RW30 27	32	--	--	--	3NE3 222	125	1	3NE4 118	63	0
3RW30 28	38	--	--	--	3NE3 222	125	1	3NE4 118	63	0
3RW30 36	45	--	--	--	3NE3 224	160	1	3NE4 120	80	0
3RW30 37	63	--	--	--	3NE3 225	200	1	3NE4 121	100	0
3RW30 38	72	3NE3 221	100	1	3NE3 227	250	1	--	--	--
3RW30 46	80	3NE3 222	125	1	3NE3 225	200	1	--	--	--
3RW30 47	106	3NE3 224	160	1	3NE3 231	350	1	--	--	--

Soft starters		Semiconductor fuses, max.			Semiconductor fuses, min.			Semiconductor fuses, max.			Cylindrical fuses	
Q11 Type	Rated current A	F3 Type	Rated current A	Size	F3 Type	Rated current A	Size	F3 Type	Rated current A	Size	F3 Type	Rated current A
<b>Type of coordination 2<sup>1)</sup>: I<sub>q</sub> = 65 kA at 480 V 10 %</b>												
3RW30 03 <sup>2)</sup>	3	--	--	--	3NE8 015-1	25	00	3NE8 015-1	25	00	3NC1 010	10
3RW30 13	3.6	--	--	--	3NE8 015-1	25	00	3NE8 015-1	25	00	3NC2 220	20
3RW30 14	6.5	--	--	--	3NE8 015-1	25	00	3NE8 015-1	25	00	3NC2 220	20
3RW30 16	9	--	--	--	3NE8 015-1	25	00	3NE8 015-1	25	00	3NC2 220	20
3RW30 17	12.5	--	--	--	3NE8 015-1	25	00	3NE8 018-1	63	00	3NC2 250	50
3RW30 18	17.6	--	--	--	3NE8 003-1	35	00	3NE8 021-1	100	00	3NC2 263	63
3RW30 26	25	3NE4 117	50	0	3NE8 017-1	50	00	3NE8 021-1	100	00	3NC2 263	63
3RW30 27	32	3NE4 118	63	0	3NE8 018-1	63	00	3NE8 022-1	125	00	3NC2 280	80
3RW30 28	38	3NE4 118	63	0	3NE8 020-1	80	00	3NE8 022-1	125	00	3NC2 280	80
3RW30 36	45	3NE4 120	80	0	3NE8 020-1	80	00	3NE8 024-1	160	00	3NC2 280	80
3RW30 37	63	3NE4 121	100	0	3NE8 021-1	100	00	3NE8 024-1	160	00	--	--
3RW30 38	72	--	--	--	3NE8 022-1	125	00	3NE8 024-1	160	00	--	--
3RW30 46	80	--	--	--	3NE8 022-1	125	00	3NE8 024-1	160	00	--	--
3RW30 47	106	--	--	--	3NE8 024-1	160	00	3NE8 024-1	160	00	--	--

Soft starters		Line contactors (optional)	Motor starter protectors		Line protection, maximum		
Q11 Type	Rated current A	Q21	400 V + 10 % Q1 Type	Rated current A	F1 Type	Rated current A	Size
<b>Type of coordination 2<sup>1)</sup>: I<sub>q</sub> = 65 kA at 480 V 10 %</b>							
3RW30 03 <sup>2)</sup>	3	3RT10 15	3RV10 11-1EA10	4	3NA3 805 <sup>3)</sup>	20	000
3RW30 13	3.6	3RT10 15	3RV10 21-1FA10	5	3NA3 803-6	10	000
3RW30 14	6.5	3RT10 15	3RV10 21-1HA10	8	3NA3 805-6	16	000
3RW30 16	9	3RT10 16	3RV10 21-1JA10	10	3NA3 807-6	20	000
3RW30 17	12.5	3RT10 24	3RV10 21-1KA10	12.5	3NA3 810-6	25	000
3RW30 18	17.6	3RT10 26	3RV10 21-1BA10	20	3NA3 814-6	35	000
3RW30 26	25	3RT10 26	3RV10 31-4DA10	25	3NA3 822-6	63	00
3RW30 27	32	3RT10 34	3RV10 31-4EA10	32	3NA3 824-6	80	00
3RW30 28	38	3RT10 35	3RV10 31-4FA10	40	3NA3 824-6	80	00
3RW30 36	45	3RT10 36	3RV10 31-4GA10	45	3NA3 130-6	100	1
3RW30 37	63	3RT10 44	3RV10 41-4JA10	63	3NA3 132-6	125	1
3RW30 38	72	3RT10 45	3RV10 41-4KA10	75	3NA3 132-6	125	1
3RW30 46	80	3RT10 45	3RV10 41-4LA10	90	3NA3 136-6	160	1
3RW30 47	106	3RT10 46	3RV10 41-4MA10	100	3NA3 136-6	160	1

<sup>1)</sup> The types of coordination are explained in more detail in Catalog LV 1, "Load Feeders, Motor Starters and Soft Starters" → "Fuseless Load Feeders". The type of coordination "2" refers only to soft starters, not to any components in the feeder.

<sup>2)</sup> I<sub>q</sub> = 50 kA at 400 V.

<sup>3)</sup> 3NA3 805-1 (NH00), 5SB2 61 (DIAZED).

**Characteristic curves****Permissible installation height**

At an installation height above 2000 m, the max. permissible operational voltage is reduced to 460 V.

**More information****Application examples for normal starting (Class 10)**

**Normal starting Class 10** (up to 20 s with 300 %  $I_{n \text{ motor}}$ ).

The soft starter rating can be selected to be as high as the rating of the motor used

Application		Conveyor belt	Roller conveyor	Compressor	Small fan	Pump	Hydraulic pump
<b>Starting parameters</b>							
• Voltage ramp and current limiting							
- starting voltage	%	70	60	50	40	40	40
- starting time	s	10	10	20	20	10	10

**Note:**

*These tables present sample set values and device sizes. They are intended only for the purposes of information and are not binding. The set values depend on the application in question and must be optimized during start-up.*

*The soft starter dimensions should be checked where necessary with the Win-Soft Starter software or with the help of Technical Assistance.*

# 3RW Soft Starters

## 3RW30 for standard applications

### Configuration

The 3RW solid-state motor controllers are designed for easy starting conditions. In the event of deviating conditions or increased switching frequency, it may be necessary to choose a larger device. For accurate dimensioning, use the Win-Soft Starter selection and simulation program.

If necessary, an overload relay for heavy starting must be selected where long starting times are involved. PTC sensors are recommended.

In the motor feeder between the SIRIUS 3RW soft starter and the motor, no capacitive elements are permitted (e.g. no reactive-power compensation equipment). In addition, neither static systems for reactive-power compensation nor dynamic PFC (Power Factor Correction) must be operated in parallel during starting and ramp-down of the soft starter. This is important to prevent faults arising on the compensation equipment and/or the soft starter.

All elements of the main circuit (such as fuses, controls and overload relays) should be dimensioned for direct starting, following the local short-circuit conditions. Fuses, controls and overload relays must be ordered separately. Please observe the maximum switching frequencies specified in the technical specifications.

#### Note:

*When induction motors are switched on, voltage drops occur as a rule on starters of all types (direct starters, wye-delta starters, soft starters). The infeed transformer must always be dimensioned such that the voltage dip when starting the motor remains within the permissible tolerance. If the infeed transformer is dimensioned with only a small margin, it is best for the control voltage to be supplied from a separate circuit (independently of the main voltage) in order to avoid the potential switching off of the soft starter.*

### Power electronics schematic circuit diagram

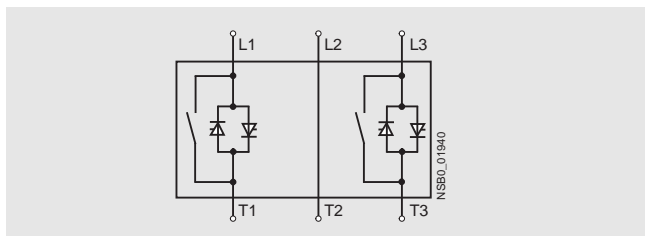

A bypass contact system is already integrated in the 3RW30 soft starter and therefore does not have to be ordered separately.

### Status graphs

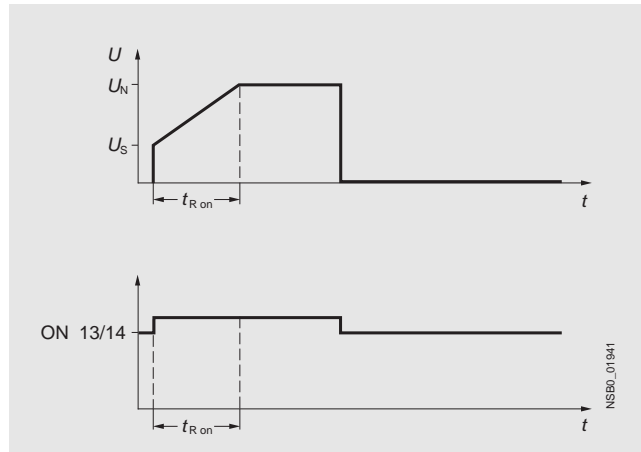

### Win-Soft Starter selection and simulation program

With this software, you can simulate and select all Siemens soft starters, taking into account various parameters such as mains properties, motor and load data, and special application requirements.

The software is a valuable tool, which makes complicated, lengthy manual calculations for determining the required soft starters superfluous.

You can order the CD-ROM under the following order number: Order No. E20001-D1020-P302-V2-7400.

You can find more information on the Internet at: <http://www.siemens.com/softstarter>

## Function

The space required by the compact SIRIUS 3RW40 soft starter is often only about one third of that required by a wye-delta assembly of comparable rating. This not only saves space in the control cabinet and on the standard mounting rail but also does away completely with the wiring work needed for wye-delta starters. This is notable in particular for higher motor ratings which are only rarely available as fully wired solutions.

At the same time the number of cables from the starter to the motor is reduced from six to three. Compact dimensions, short start-up times, easy wiring and fast commissioning make themselves felt as clear-cut cost advantages.

The bypass contacts of these soft starters are protected during operation by an integrated solid-state arc quenching system. This prevents damage to the bypass contacts in the event of a fault, e.g. brief disconnection of the control voltage, mechanical shocks or life-related component defects on the coil operating mechanism or main contact spring.

The starting current of particularly powerful operating mechanisms can place an unjustifiable load on the local supply system. Soft starters reduce this starting current by means of their voltage ramp. Thanks to the adjustable current limiting, the SIRIUS 3RW40 soft starter takes even more pressure off the supply system. It leaves the set start ramp during the ramp-up – the ramp gradient is fixed by the starting voltage and the ramp time – as soon as the selected current limit is reached. From this moment the voltage of the soft starter is controlled so that the current supplied to the motor remains constant. This process is ended either by completion of the motor ramp-up or by tripping by the intrinsic device protection or the motor overload protection. As the result of this function the actual motor ramp-up can well take longer than the ramp time selected on the soft starter.

Thanks to the integrated motor overload protection according to IEC 60947-4-2 there is no need of an additional overload relay on the new soft starters. The rated motor current, the setting of the overload tripping time (Class times) and the reset of the motor overload protection function can be adjusted easily and quickly. Using a 4-step rotary potentiometer it is possible to set different overload tripping times on the soft starter. In addition to Class 10, 15 and 20 it is also possible to switch off the motor overload protection if a different motor management control device is to be used for this function, e.g. with connection to PROFIBUS.

Device versions with thermistor motor protection evaluation are available up to a rating of 55 kW (at 400 V). A "Thermoclick" measuring probe can be connected directly, as can a PTC of type A. Thermal overloading of the motor, open-circuits and short-circuits in the sensor circuit all result in the direct disconnection of the soft starter. And if ever the soft starter trips, various reset options are available the same as with intrinsic device protection and motor load protection: manually with the reset button, automatically or remotely through brief disconnection of the control voltage.

The new series of devices comes with the "polarity balancing" control method, which is designed to prevent direct current components in two-phase controlled soft starters. On two-phase controlled soft starters the current resulting from superimposition of the two controlled phases flows in the uncontrolled phase. This results for physical reasons in an asymmetric distribution of the three phase currents during the motor ramp-up. This phenomenon cannot be influenced, but in most applications it is non-critical.

Controlling the power semiconductors results not only in this asymmetry, however, but also in the previously mentioned direct current components which can cause severe noise generation on the motor at starting voltages of less than 50 %.

The control method used for these soft starters eliminates these direct current components during the ramp-up phase and prevents the braking torque which they can cause. It creates a motor ramp-up that is uniform in speed, torque and current rise, thus permitting a particularly gentle, two-phase starting of the motors. At the same time the acoustic quality of the starting operation comes close to the quality of a three-phase controlled soft starter. This is made possible by the on-going dynamic harmonizing and balancing of current half-waves of different polarity during the motor ramp-up. Hence the name "polarity balancing".

As an option the thyristors can also be protected by SITOR semiconductor fuses from short-circuiting so that the soft starter is still functional after a short-circuit (coordination type 2). Three LEDs are used to indicate the operating state as well as possible errors, e.g. non-permissible tripping time (CLASS setting), mains or phase failure, missing load, thermal overloading or device faults.

- Soft starting with voltage ramp; the starting voltage setting range  $U_s$  is 40 to 100 % and the ramp time  $t_R$  can be set from 0 to 20 s.
- Smooth ramp-down with voltage ramp; the running down time  $t_{off}$  can be set between 0 s to 20 s.
- Solid-state motor overload and intrinsic device protection
- Optional thermistor motor protection (up to size S3)
- Remote reset (integrated up to size S3, optional for size S6 and larger)
- Adjustable current limiting
- Integrated bypass contact system to minimize power loss
- Setting with potentiometers
- Simple mounting and start-up
- Integrated status monitoring and fault monitoring
- Mains voltages 50/60 Hz, 200 ... 600 V
- Various control voltage versions
  - sizes S0 to S3: 24 V AC/DC and 110 ... 230 V AC/DC
  - sizes S6 to S12: 115 V AC and 230 V AC. Control by way of the internal 24 V DC supply and direct control by means of PLC are possible.
- Wide temperature range from -25 to +60 °C
- Built-in auxiliary contacts ensure user-friendly control and possible further processing within the system ([for status graphs see page 6/36](#))



# 3RW Soft Starters

## 3RW40 for standard applications

### Technical specifications

Type	3RW40 2.		3RW40 3., 3RW40 4.			
<b>Control electronics</b>						
<b>Rated values</b>	Terminal A1/A2	V	24	110 ... 230	24	110 ... 230
Rated control supply voltage		%	±20	-15/+10	±20	-15/+10
• Tolerance						
Rated control supply current		mA	< 150	< 50	< 200	< 50
• STANDBY		mA	< 200	< 100	< 5000	< 1500
• During pick-up		mA	< 250	< 50	< 200	< 50
• ON without fan		mA	< 300	< 70	< 250	< 70
• ON with fan		mA				
Rated frequency		Hz	50/60			
• Tolerance		%	±10			
<b>Control inputs</b>						
IN			ON/OFF			
Rated operational current		mA	Approx. 12	3/6	Approx. 12	3/6
• AC		mA	Approx. 12	1.5/3	Approx. 12	1.5/3
• DC		mA				
<b>Relay outputs</b>						
Output 1	ON/RUN mode <sup>1)</sup>	13/14	Operating indication (NO)			
Output 2	BYPASSED	23/24	Bypass indication (NO)			
Output 3	OVERLOAD/FAILURE	95/96/98	Overload/error indication (NC/NO)			
Rated operational current		A	3 AC-15/AC-14 at 230 V, 1 DC-13 at 24 V			
		A				
Protection against overvoltages			Protection by means of varistor through contact			
Short-circuit protection			4 A gL/gG operational class; 6 A quick (fuse is not included in scope of supply)			

<sup>1)</sup> Factory default: ON mode.

Type	3RW40 5.		3RW40 7.			
<b>Control electronics</b>						
<b>Rated values</b>	Terminal A1/A2	V AC	115	230	115	230
Rated control supply voltage		%	-15/+10		-15/+10	
• Tolerance						
Rated control supply current STANDBY		mA	15		15	
Rated control supply current ON <sup>1)</sup>		mA	440	200	660	360
Rated frequency		Hz	50/60		50/60	
• Tolerance		%	±10		±10	
<b>Control inputs</b>						
IN			ON/OFF			
Rated operational current		mA	Approx. 10 according to DIN 19240			
Rated operational voltage		V DC	24 from internal supply dc+ or external DC supply (according to DIN 19240) through terminals and IN			
<b>Relay outputs</b>						
Output 1	ON/RUN mode <sup>2)</sup>	13/14	Operating indication (NO)			
Output 2	BYPASSED	23/24	Bypass indication (NO)			
Output 3	OVERLOAD/FAILURE	95/96/98	Overload/error indication (NC/NO)			
Rated operational current		A	3 AC-15/AC-14 at 230 V, 1 DC-13 at 24 V			
		A				
Protection against overvoltages			Protection by means of varistor through contact			
Short-circuit protection			4 A gL/gG operational class; 6 A quick (fuse is not included in scope of supply)			

<sup>1)</sup> Values for the coil power consumption at +10 %  $U_n$ , 50 Hz.

<sup>2)</sup> Factory default: ON mode.

Type	3RW40 2., 3RW40 3., 3RW40 4.			
<b>Control electronics</b>				
<b>Operating indications</b>	LEDs	<b>DEVICE</b>	<b>STATE/BYPASSED/FAILURE</b>	<b>OVERLOAD</b>
Off		Green	Off	Off
Start		Green	Green flashing	Off
Bypass		Green	Green	Off
Ramp-down		Green	Green flashing	Off
<b>Alarm signals</b>				
$I_g$ class setting not permissible		Green	Not relevant	Red flashing
Start inhibited/thyristors too hot		Yellow flashing	Not relevant	Off
<b>Error signals</b>				
• 24 V: $U < 0.75 \times U_s$ or $U > 1.25 \times U_s$		Off	Red	Off
• 110 ... 230 V: $U < 0.75 \times U_s$ or $U > 1.15 \times U_s$		Off	Red	Off
Non-permissible $I_g$ Class setting for edge 0 → 1 on input IN		Green	Red	Red flashing
Motor protection shut-down (overload thermistor)		Green	Off	Red
Thermistor defective (open-circuit, short-circuit)		Green	Off	Red flickering
Thermal overloading of the thyristors		Yellow	Red	Off
Missing mains voltage, phase failure, missing load		Green	Red	Off
Device fault		Red	Red	Off

Type	3RW40 5. and 3RW40 7.				
<b>Control electronics</b>					
<b>Operating indications</b>	LEDs	<b>DEVICE</b>	<b>STATE/BYPASSED</b>	<b>FAILURE</b>	<b>OVERLOAD</b>
Off		Green	Off	Off	Off
Start		Green	Green flashing	Off	Off
Bypass		Green	Green	Off	Off
Ramp-down		Green	Green flashing	Off	Off
<b>Alarm signals</b>					
$I_d$ /class setting not permissible		Green	Not relevant	Not relevant	Red flashing
Start inhibited/thyristors too hot		Yellow flashing	Not relevant	Not relevant	Off
<b>Error signals</b>					
$U < 0.75 \times U_s$ or $U > 1.15 \times U_s$		Off	Off	Red	Off
Non-permissible $I_d$ /Class setting for edge 0 → 1 on input IN		Green	Off	Red	Red flashing
Motor protection shut-down		Green	Off	Off	Red
Thermal overloading of the thyristors		Yellow	Off	Red	Off
Missing mains voltage, phase failure, missing load		Green	Off	Red	Off
Device fault		Red	Off	Red	Off
<b>3RW40 ..</b>					
				Factory default	
<b>Protection functions</b>					
<b>Motor protection functions</b>					
Trips in the event of		Thermal overloading of the motor			
Trip class to IEC 60947-4-1	Class	10/15/20	10		
Phase failure sensitivity	%	> 40			
Overload warning		No			
Thermistor protection according to IEC 60947-8, type A/IEC 60947-5-1		Yes <sup>1)</sup>			
Reset option after tripping		Manual/automatic/remote reset <sup>2)</sup> (MAN/AUTO/REMOTE <sup>2)</sup> )			
Recovery time	min	5			
<b>Device protection functions</b>					
Trips in the event of		Thermal overloading of the thyristors or bypass <sup>3)</sup>			
Reset option after tripping		Manual/automatic/remote reset <sup>2)</sup> (MAN/AUTO/REMOTE <sup>2)</sup> )			
Recovery time					
• During overloading of the thyristors	s	30			
• During overloading of the bypass	s	60			
<b>Control times and parameters</b>					
<b>Control times</b>					
Closing delay (with connected control voltage)	ms	< 50			
Closing delay (automatic/mains contactor mode)	ms	<300			
Recovery time (closing command in active ramp-down)	ms	100			
<b>Mains failure bridging time</b>					
Control supply voltage	ms	50			
<b>Mains failure response time</b>					
Load current circuit	ms	500			
<b>Reclosing lockout after overload trip</b>					
Motor protection trip	min	5			
Device protection trip					
• During overloading of the thyristors	s	30			
• During overloading of the bypass	s	60			
<b>Starting parameters</b>					
Starting time	s	0 ... 20	7.5		
Starting voltage	%	40 ... 100	40		
Starting current limit		1.3 ... 5 x $I_e$	5 x $I_e$		
<b>Ramp-down parameters</b>					
Ramp-down time	s	0 ... 20	0		
<b>Reset mode parameters</b> (for motor/device protection shut-down)					
Manual reset	LEDs	Off	Off		
Automatic reset	LEDs	Yellow			
Remote reset (REMOTE) <sup>2)</sup>	LEDs	Green			
<b>Start-up detection</b>					
		Yes			
<b>Operating mode output 13/14</b>					
Rising edge at	Start command	ON			
Falling edge at	Off command	ON			
	Ramp-down end	RUN			

<sup>1)</sup> Optional up to size S3 (device variant).

<sup>2)</sup> Integrated remote reset (REMOTE) available only for 3RW40 2. to 3RW40 4.; remote reset with accessory module 3RU19 available for 3RW40 5. and 3RW40 7..

<sup>3)</sup> Bypass protection up to size S3.

# 3RW Soft Starters

## 3RW40 for standard applications

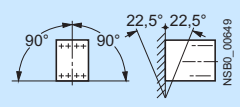
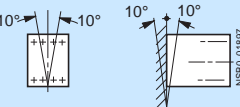
Type		3RW40 2.-..B.4, 3RW40 3.-..B.4, 3RW40 4.-..B.4	3RW40 2.-..B.5, 3RW40 3.-..B.5, 3RW40 4.-..B.5	3RW40 5.-.BB.4, 3RW40 7.-.BB.4	3RW40 5.-.BB.5, 3RW40 7.-.BB.5
<b>Power electronics</b>					
<b>Rated operational voltage</b>	V AC	200 ... 480	400 ... 600	200 ... 460	400 ... 600
Tolerance	%	-15/+10	-15/+10	-15/+10	-15/+10
<b>Rated frequency</b>	Hz	50/60			
Tolerance	%	±10			
<b>Continuous duty</b> at 40 °C (% of $I_e$ )	%	115			
<b>Minimum load</b> (% of minimum selectable rated motor current $I_M$ )	%	20 (at least 2 A)			
<b>Maximum cable length</b> between soft starter and motor	m	300			
<b>Permissible installation height</b>	m	5000 (derating from 1000, see characteristic curves); higher on request			
<b>Permissible mounting position</b>		<ul style="list-style-type: none"> <li>With auxiliary fan (for 3RW40 2. ... 3RW40 4.)</li> </ul>  <ul style="list-style-type: none"> <li>Without auxiliary fan (for 3RW40 2. ... 3RW40 4.)</li> </ul>  <p>-- (fan integrated in the soft starter)</p>			
<b>Permissible ambient temperature</b>		Operation °C: -25 ... +60; (derating from +40) Storage °C: -40 ... +80			
<b>Degree of protection</b>		IP20 for 3RW40 2.; IP00 for 3RW40 3. and 3RW40 4.		IP00	

Type		3RW40 24	3RW40 26	3RW40 27	3RW40 28
<b>Power electronics</b>					
<b>Load rating with rated operational current <math>I_e</math></b>					
<ul style="list-style-type: none"> <li>According to IEC and UL/CSA<sup>1)</sup>, for individual mounting, AC-53a</li> </ul>					
- at 40 °C	A	12.5	25.3	32.2	38
- at 50 °C	A	11	23	29	34
- at 60 °C	A	10	21	26	31
<b>Smallest adjustable rated motor current <math>I_M</math></b>					
For the motor overload protection	A	5	10	17	23
<b>Power loss</b>					
<ul style="list-style-type: none"> <li>In operation after completed ramp-up with uninterrupted rated operational current (40 °C) approx.</li> </ul>					
	W	2	8	13	19
<ul style="list-style-type: none"> <li>During starting with current limit set to 300 % <math>I_M</math> (40°C)</li> </ul>					
	W	17	47	55	64
<b>Permissible rated motor current and starts per hour</b>					
<ul style="list-style-type: none"> <li><b>For normal starting (Class 10)</b></li> </ul>					
- rated motor current $I_M^{(2)}$ , starting time 3 s	A	12.5	25	32	38
- starts per hour <sup>3)</sup>	1/h	50	23	23	19
- rated motor current $I_M^{(2)4)}$ , starting time 4 s	A	12.5	25	32	38
- starts per hour <sup>3)</sup>	1/h	36	15	16	12
<ul style="list-style-type: none"> <li><b>For heavy starting (Class 15)</b></li> </ul>					
- rated motor current $I_M^{(2)}$ , starting time 4.5 s	A	11	23	30	34
- starts per hour <sup>3)</sup>	1/h	49	21	18	18
- rated motor current $I_M^{(2)4)}$ , starting time 6 s	A	11	23	30	34
- starts per hour <sup>3)</sup>	1/h	36	14	13	13
<ul style="list-style-type: none"> <li><b>For heavy starting (Class 20)</b></li> </ul>					
- rated motor current $I_M^{(2)}$ , starting time 6 s	A	10	21	27	31
- starts per hour <sup>3)</sup>	1/h	47	21	20	18
- rated motor current $I_M^{(2)4)}$ , starting time 8 s	A	10	21	27	31
- starts per hour <sup>3)</sup>	1/h	34	15	14	13

<sup>1)</sup> Measurement at 60 °C according to UL/CSA not required.

<sup>2)</sup> Current limit on soft starter set to 300 %  $I_M$ .

<sup>3)</sup> For intermittent duty S4 with ON period = 30 %,  $T_U = 40$  °C, stand-alone installation vertical. The quoted switching frequencies do not apply for automatic mode.

<sup>4)</sup> Maximum adjustable rated motor current  $I_M$ , dependent on CLASS setting.

Type		3RW40 36	3RW40 37	3RW40 38	3RW40 46	3RW40 47
<b>Power electronics</b>						
<b>Load rating with rated operational current <math>I_e</math></b>						
• According to IEC and UL/CSA <sup>1)</sup> , for individual mounting, AC-53a						
- at 40 °C	A	45	63	72	80	106
- at 50 °C	A	42	58	62.1	73	98
- at 60 °C	A	39	53	60	66	90
<b>Smallest adjustable rated motor current <math>I_M</math></b>						
For the motor overload protection	A	23	26	35	43	46
<b>Power loss</b>						
• In operation after completed ramp-up with uninterrupted rated operational current (40 °C) approx.	W	6	12	15	12	21
• During starting with current limit set to 300 % $I_M$ (40 °C)	W	79	111	125	144	192
<b>Permissible rated motor current and starts per hour</b>						
<b>• For normal starting (Class 10)</b>						
- rated motor current $I_M^{(2)}$ , starting time 3 s	A	45	63	72	80	106
- starts per hour <sup>3)</sup>	1/h	38	23	22	22	15
- rated motor current $I_M^{(2)4)}$ , starting time 4 s	A	45	63	72	80	106
- starts per hour <sup>3)</sup>	1/h	26	15	15	15	10
<b>• For heavy starting (Class 15)</b>						
- rated motor current $I_M^{(2)}$ , starting time 4.5 s	A	42	50	56	70	84
- starts per hour <sup>3)</sup>	1/h	30	34	34	24	23
- rated motor current $I_M^{(2)4)}$ , starting time 6 s	A	42	50	56	70	84
- starts per hour <sup>3)</sup>	1/h	21	24	24	16	17
<b>• For heavy starting (Class 20)</b>						
- rated motor current $I_M^{(2)}$ , starting time 6 s	A	38	46	50	64	77
- starts per hour <sup>3)</sup>	1/h	30	31	34	23	23
- rated motor current $I_M^{(2)4)}$ , starting time 8 s	A	38	46	50	64	77
- starts per hour <sup>3)</sup>	1/h	21	22	24	16	16

1) Measurement at 60 °C according to UL/CSA not required.

2) Current limit on soft starter set to 300 %  $I_M$ .

3) For intermittent duty S4 with ON period = 30 %,  $T_U = 40$  °C, stand-alone installation vertical. The quoted switching frequencies do not apply for automatic mode.

4) Maximum adjustable rated motor current  $I_M$ , dependent on CLASS setting.

Type		3RW40 55	3RW40 56	3RW40 73	3RW40 74	3RW40 75	3RW40 76
<b>Power electronics</b>							
<b>Load rating with rated operational current <math>I_e</math></b>							
• According to IEC and UL/CSA <sup>1)</sup> , for individual mounting, AC-53a							
- at 40 °C	A	134	162	230	280	356	432
- at 50 °C	A	117	145	205	248	315	385
- at 60 °C	A	100	125	180	215	280	335
<b>Smallest adjustable rated motor current <math>I_M</math></b>							
For the motor overload protection	A	59	87	80	130	131	207
<b>Power loss</b>							
• In operation after completed ramp-up with uninterrupted rated operational current (40 °C) approx.	W	60	75	75	90	125	165
• During starting with current limit set to 350 % <sup>2)</sup> $I_M$ (40 °C)	W	1043	1355	2448	3257	3277	3600
<b>Permissible rated motor current and starts per hour</b>							
<b>• For normal starting (Class 10)</b>							
- rated motor current $I_M^{(2)}$ , starting time 10 s	A	134	162	230	280	356	432
- starts per hour <sup>3)</sup>	1/h	20	8	14	20	16	17
- rated motor current $I_M^{(2)4)}$ , starting time 20 s	A	134	162	230	280	356	432
- starts per hour <sup>3)</sup>	1/h	7	1.4	3	8	5	5
<b>• For heavy starting (Class 15)</b>							
- rated motor current $I_M^{(2)}$ , starting time 15 s	A	134	152	210	250	341	402
- starts per hour <sup>3)</sup>	1/h	11	8	11	13	11	12
- rated motor current $I_M^{(2)4)}$ , starting time 30 s	A	134	152	210	250	341	402
- starts per hour <sup>3)</sup>	1/h	1.2	1.7	1	6	2	2
<b>• For heavy starting (Class 20)</b>							
- rated motor current $I_M^{(2)}$ , starting time 20 s	A	124	142	200	230	311	372
- starts per hour <sup>3)</sup>	1/h	12	9	10	10	10	10
- rated motor current $I_M^{(2)4)}$ , starting time 40 s	A	124	142	200	230	311	372
- starts per hour <sup>3)</sup>	1/h	2	2	1	5	1	1

1) Measurement at 60 °C according to UL/CSA not required.



2) Current limit on soft starter set to 350 %  $I_M$ .





3) For intermittent duty S4 with ON period = 70 %,  $T_U = 40$  °C, stand-alone installation vertical. The quoted switching frequencies do not apply for automatic mode.

4) Maximum adjustable rated motor current  $I_M$ , dependent on CLASS setting.

# 3RW Soft Starters

## 3RW40 for standard applications

Soft starters	Type		3RW40 2.	3RW40 3.	3RW40 4.
<b>Conductor cross-sections</b>					
<b>Screw terminals</b>	<b>Main conductors</b>				
<b>Front clamping point connected</b>	• Solid	mm <sup>2</sup>	2 x (1.5 ... 2.5); 2 x (2.5 ... 6) according to IEC 60947; max. 1 x 10	2 x (1.5 ... 16)	2 x (2.5 ... 16)
	• With end sleeve	mm <sup>2</sup>	2 x (1.5 ... 2.5); 2 x (2.5 ... 6)	1 x (0.75 ... 25)	1 x (2.5 ... 35)
	• Stranded	mm <sup>2</sup>	--	1 x (0.75 ... 35)	1 x (4 ... 70)
	• AWG cables				
	- solid or stranded	AWG	2 x (14 ... 10)	1 x (18 ... 2)	2 x (10 ... 1/0)
	- stranded	AWG	1 x 8	--	--
<b>Rear clamping point connected</b>	• Solid	mm <sup>2</sup>	--	2 x (1.5 ... 16)	2 x (2.5 ... 16)
	• With end sleeve	mm <sup>2</sup>	--	1 x (1.5 ... 25)	1 x (2.5 ... 50)
	• Stranded	mm <sup>2</sup>	--	1 x (1.5 ... 35)	1 x (10 ... 70)
	• AWG cables				
	- solid or stranded	AWG	--	1 x (16 ... 2)	2 x (10 ... 1/0)
<b>Both clamping points connected</b>	• Solid	mm <sup>2</sup>	--	2 x (1.5 ... 16)	2 x (2.5 ... 16)
	• With end sleeve	mm <sup>2</sup>	--	2 x (1.5 ... 16)	2 x (2.5 ... 35)
	• Stranded	mm <sup>2</sup>	--	2 x (1.5 ... 25)	2 x (10 ... 50)
	• AWG cables				
	- solid or stranded	AWG	--	2 x (16 ... 2)	1 x (10 ... 2/0)
	• Tightening torque	Nm lb.in	2 ... 2.5 18 ... 22	4.5 40	6.5 58
	Tools		PZ 2	PZ 2	Allen screw 4 mm
	Degree of protection		IP20	IP20 (IP00 terminal compartment)	IP20 (IP00 terminal compartment)
<b>Spring-loaded terminals</b>	<b>Main conductors</b>				
	• Solid	mm <sup>2</sup>	1 ... 10	--	--
	• Finely stranded with end sleeve	mm <sup>2</sup>	1 ... 6 end sleeves with- out plastic collar	--	--
	• AWG cables				
	- solid or stranded (finely stranded)	AWG	16 ... 10	--	--
	- stranded	AWG	1 x 8	--	--
	Tools		DIN ISO 2380-1A0; 5 x 3	--	--
	Degree of protection		IP20	--	--
<b>Busbar connections</b>	<b>Main conductors</b>				
	• With cable lug according to DIN 46234 or max. 20 mm wide				
	- stranded	mm <sup>2</sup>	--	--	2 x (10 ... 70)
	- finely stranded	mm <sup>2</sup>	--	--	2 x (10 ... 50)
	• AWG cables, solid or stranded	AWG	--	--	2 x (7 ... 1/0)

Soft starters	Type		3RW40 5.	3RW40 7.
<b>Conductor cross-sections</b>				
<b>Screw terminals</b>	<b>Main conductors</b>			
<b>With box terminal</b>				
<b>Front clamping point connected</b>	<ul style="list-style-type: none"> <li>Finely stranded with end sleeve</li> <li>Finely stranded without end sleeve</li> <li>Stranded</li> <li>Ribbon cable conductors (number x width x thickness)</li> <li>AWG cables, solid or stranded</li> </ul>	mm <sup>2</sup> mm <sup>2</sup> mm <sup>2</sup> mm AWG	3RT19 55-4G (55 kW) 16 ... 70 16 ... 70 16 ... 70 Min. 3 x 9 x 0.8 Max. 6 x 15.5 x 0.8 6 ... 2/0	3RT19 66-4G 70 ... 240 70 ... 240 95 ... 300 Min. 6 x 9 x 0.8 Max. 20 x 24 x 0.5 3/0 ... 600 kcmil
				
<b>Rear clamping point connected</b>	<ul style="list-style-type: none"> <li>Finely stranded with end sleeve</li> <li>Finely stranded without end sleeve</li> <li>Stranded</li> <li>Ribbon cable conductors (number x width x thickness)</li> <li>AWG cables, solid or stranded</li> </ul>	mm <sup>2</sup> mm <sup>2</sup> mm <sup>2</sup> mm AWG	16 ... 70 16 ... 70 16 ... 70 Min. 3 x 9 x 0.8 Max. 6 x 15.5 x 0.8 6 ... 2/0	120 ... 185 120 ... 185 120 ... 240 Min. 6 x 9 x 0.8 Max. 20 x 24 x 0.5 250 ... 500 kcmil
				
<b>Both clamping points connected</b>	<ul style="list-style-type: none"> <li>Finely stranded with end sleeve</li> <li>Finely stranded without end sleeve</li> <li>Stranded</li> <li>Ribbon cable conductors (number x width x thickness)</li> <li>AWG cables, solid or stranded</li> <li>Terminal screws - tightening torque</li> </ul>	mm <sup>2</sup> mm <sup>2</sup> mm <sup>2</sup> mm AWG Nm lb.in	Max. 1 x 50, 1 x 70 Max. 1 x 50, 1 x 70 Max. 2 x 70 Max. 2 x (6 x 15.5 x 0.8) Max. 2 x 1/0 M10 (hexagon socket, A/F4) 10 ... 12 90 ... 110	Min. 2 x 50; max. 2 x 185 Min. 2 x 50; max. 2 x 185 Max. 2 x 70; max. 2 x 240 Max. 2 x (20 x 24 x 0.5) Min. 2 x 2/0 Max. 2 x 500 kcmil M12 (hexagon socket, A/F5) 20 ... 22 180 ... 195
				
<b>Screw terminals</b>	<b>Main conductors</b>			
<b>With box terminal</b>				
<b>Front or rear clamping point connected</b>	<ul style="list-style-type: none"> <li>Finely stranded with end sleeve</li> <li>Finely stranded without end sleeve</li> <li>Stranded</li> <li>Ribbon cable conductors (number x width x thickness)</li> <li>AWG cables, solid or stranded</li> </ul>	mm <sup>2</sup> mm <sup>2</sup> mm <sup>2</sup> mm AWG	3RT19 56-4G 16 ... 120 16 ... 120 16 ... 120 Min. 3 x 9 x 0.8 Max. 6 x 15.5 x 0.8 6 ... 250 kcmil	
				
<b>Both clamping points connected</b>	<ul style="list-style-type: none"> <li>Finely stranded with end sleeve</li> <li>Finely stranded without end sleeve</li> <li>Stranded</li> <li>Ribbon cable conductors (number x width x thickness)</li> <li>AWG cables, solid or stranded</li> </ul>	mm <sup>2</sup> mm <sup>2</sup> mm <sup>2</sup> mm AWG	Max. 1 x 95, 1 x 120 Max. 1 x 95, 1 x 120 Max. 2 x 120 Max. 2 x (10 x 15.5 x 0.8) Max. 2 x 3/0	
				
<b>Screw terminals</b>	<b>Main conductors</b>			
	<u>Without box terminal/busbar connection</u>			
	<ul style="list-style-type: none"> <li>Finely stranded with cable lug</li> <li>Stranded with cable lug</li> <li>AWG cables, solid or stranded</li> <li>Connecting bar (max. width)</li> <li>Terminal screws - tightening torque</li> </ul>	mm <sup>2</sup> mm <sup>2</sup> AWG mm Nm lb.in	16 ... 95 <sup>1)</sup> 25 ... 120 <sup>1)</sup> 4 ... 250 kcmil 17 M8 x 25 (A/F13) 10 ... 14 89 ... 124	50 ... 240 <sup>2)</sup> 70 ... 240 <sup>2)</sup> 2/0 ... 500 kcmil 25 M10 x 30 (A/F17) 14 ... 24 124 ... 210

<sup>1)</sup> When connecting cable lugs to DIN 46235, use 3RT19 56-4EA1 terminal cover for conductor cross-sections from 95 mm<sup>2</sup> to ensure phase spacing.

<sup>2)</sup> When connecting cable lugs to DIN 46234, the 3RT19 66-4EA1 terminal cover must be used for conductor cross-sections of 240 mm<sup>2</sup> and more as well as DIN 46235 for conductor cross-sections of 185 mm<sup>2</sup> and more to keep the phase clearance.

Soft starters	Type		3RW40 ..
<b>Conductor cross-sections</b>			
<b>Auxiliary conductors</b> (1 or 2 conductors can be connected):			
<b>Screw terminals</b>			
<ul style="list-style-type: none"> <li>Solid</li> <li>Finely stranded with end sleeve</li> <li>AWG cables - solid or stranded</li> <li>finely stranded with end sleeve</li> <li>Terminal screws - tightening torque</li> </ul>	mm <sup>2</sup> mm <sup>2</sup> AWG AWG Nm lb.in	2 x (0.5 ... 2.5) 2 x (0.5 ... 1.5) 2 x (20 ... 14) 2 x (20 ... 16) 0.8 ... 1.2 7 ... 10.3	
<b>Spring-loaded terminals</b>			
<ul style="list-style-type: none"> <li>Solid - 3RW40 2. ... 3RW40 4. - 3RW40 5., 3RW40 7.</li> <li>Finely stranded with end sleeve</li> <li>AWG cables, solid or stranded</li> </ul>	mm <sup>2</sup> mm <sup>2</sup> mm <sup>2</sup> AWG	2 x (0.25 ... 2.5) 2 x (0.25 ... 1.5) 2 x (0.25 ... 1.5) 2 x (24 ... 14) for 3RW40 2. ... 3RW40 4.; 2 x (24 ... 16) for 3RW40 5. and 3RW40 7.	

# 3RW Soft Starters

## 3RW40 for standard applications

	Standard	Parameters
<b>Electromagnetic compatibility according to EN 60947-4-2</b>		
<i>EMC interference immunity</i>		
<b>Electrostatic discharge (ESD)</b>	EN 61000-4-2	±4 kV contact discharge, ±8 kV air discharge
<b>Electromagnetic RF fields</b>	EN 61000-4-3	Frequency range: 80 ... 1000 MHz with 80 % at 1 kHz Degree of severity 3: 10 V/m
<b>Conducted RF interference</b>	EN 61000-4-6	Frequency range: 150 kHz ... 80 MHz with 80 % at 1 kHz Interference 10 V
<b>RF voltages and RF currents on cables</b>		
• Burst	EN 61000-4-4	±2 kV/5 kHz
• Surge	EN 61000-4-5	±1 kV line to line ±2 kV line to earth
<i>EMC interference emission</i>		
<b>EMC interference field strength</b>	EN 55011	Limit value of Class A at 30 ... 1000 MHz, limit value of Class B with 3RW40 2. 24 V AC/DC
<b>Radio interference voltage</b>	EN 55011	Limit value of Class A at 0.15 ... 30 MHz, limit value of Class B with 3RW40 2. 24 V AC/DC
<i>Radio interference suppression filters</i>		
<b>Degree of noise suppression A</b> (industrial applications)	Not required	
<b>Degree of noise suppression B</b> (applications for residential areas)		
Control voltage		
• 110 ... 230 V AC/DC	Not available <sup>1)</sup>	
• 115/230 V AC	Not available <sup>1)</sup>	
• 24 V AC/DC	Not required for 3RW40 2.; required for 3RW40 3. and 3RW40 4. (see Table)	

<sup>1)</sup> Degree of noise suppression B cannot be obtained through the use of filters as the strength of the electromagnetic field is not attenuated by the filter.

Soft starter types	Rated current Soft starters A	Recommended filters <sup>1)</sup>		
		Voltage range 200 ... 480 V		
		Filter types	Rated current filters A	Terminals mm <sup>2</sup>
<b>3RW40 36</b>	45	4EF1512-1AA10	50	16
<b>3RW40 37</b>	63	4EF1512-2AA10	66	25
<b>3RW40 38</b>	72	4EF1512-3AA10	90	25
<b>3RW40 46</b>	80	4EF1512-3AA10	90	25
<b>3RW40 47</b>	106	4EF1512-4AA10	120	50

<sup>1)</sup> The radio interference suppression filter is used to remove the conducted interference from the main circuit. The field-related emissions comply with degree of noise suppression B.



**Fuse assignment**

The type of coordination to which the motor feeder with soft starter is mounted depends on the application-specific requirements. Normally, fuseless mounting (combination of

motor starter protector and soft starter) is sufficient. If type 2 coordination is to be fulfilled, semiconductor fuses must be fitted in the motor feeder.

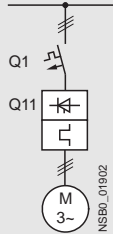
**Fuseless version****Soft starters**

Q11 Type	Rated current A
----------	-----------------

**Motor starter protectors/circuit breakers<sup>1)</sup>**

Q1 Type	Rated current A
---------	-----------------

$I_{q \max}$ kA	Rated current A
-----------------	-----------------

Q1 Type	Rated current A
---------	-----------------

$I_{q \max}$ kA	Rated current A
-----------------	-----------------

**Type of coordination 1<sup>2)</sup>**

3RW40 Type	Rated current A	3RV1 Type	3RV1 Type	$I_{q \max}$ kA	Rated current A	3RV1 Type	$I_{q \max}$ kA	Rated current A
3RW40 24	12.5	3RV1 031-4AA10	3RV1 331-4AC10	55	16	--	--	--
3RW40 26	25	3RV1 031-4DA10	3RV1 331-4DC10	55	25	--	--	--
3RW40 27	32	3RV1 031-4EA10	3RV1 331-4EC10	55	32	--	--	--
3RW40 28	38	3RV1 031-4FA10	3RV1 331-4FC10	55	40	--	--	--
3RW40 36	45	3RV1 031-4GA10	3RV1 331-4GC10	20	45	--	--	--
3RW40 37	63	3RV1 041-4JA10	3RV1 341-4JC10	20	63	--	--	--
3RW40 38	72	3RV1 041-4KA10	3RV1 341-4KC10	20	75	--	--	--
3RW40 46	80	3RV1 041-4LA10	3RV1 341-4LC10	11	90	--	--	--
3RW40 47	106	3RV1 041-4MA10	3RV1 341-4MC10	11	100	--	--	--
3RW40 55	134	3VL3 720-2DC36		35	200	3VL3 720-1DC36	12	200
3RW40 56	162	3VL3 720-2DC36		35	200	3VL3 720-1DC36	12	200
3RW40 73	230	3VL4 731-2DC36		65	315	3VL5 731-3DC36	35	315
3RW40 74	280	3VL4 731-2DC36		65	315	3VL5 731-3DC36	35	315
3RW40 75	356	3VL4 740-2DC36		65	400	3VL5 740-3DC36	35	400
3RW40 76	432	3VL5 750-2DC36		65	500	3VL5 750-3DC36	35	500

<sup>1)</sup> The rated motor current must be considered when selecting the devices.

<sup>2)</sup> The types of coordination are explained in more detail in Catalog LV 1, "Load Feeders, Motor Starters and Soft Starters" → "Fuseless Load Feeders".

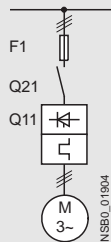
**Fused version (line protection only)****Soft starters**

Q11 Type	Rated current A
----------	-----------------

**Line protection, maximum**

F1 Type	Rated current A	Size
---------	-----------------	------

**Line contactors**

Q21 (optional)
----------------

**Type of coordination 1<sup>1)</sup>:  $I_q = 65 \text{ kA at } 600 \text{ V } +5 \%$** 

3RW40 Type	Rated current A	3NA3 Type	Rated current A	Size	3RT10 Type
3RW40 24	12.5	3NA3 820-6	50	00	3RT10 24
3RW40 26	25	3NA3 822-6	63	00	3RT10 26
3RW40 27	32	3NA3 824-6	80	00	3RT10 34
3RW40 28	38	3NA3 824-6	80	00	3RT10 35
3RW40 36	45	3NA3 130-6	100	1	3RT10 36
3RW40 37	63	3NA3 132-6	125	1	3RT10 44
3RW40 38	72	3NA3 132-6	125	1	3RT10 45
3RW40 46	80	3NA3 136-6	160	1	3RT10 45
3RW40 47	106	3NA3 136-6	160	1	3RT10 46
3RW40 55	134	3NA3 244-6	250	2	3RT10 55-6A.36
3RW40 56	162	3NA3 244-6	250	2	3RT10 56-6A.36
3RW40 73	230	2 x 3NA3 354-6	2 x 355	3	3RT10 65-6A.36
3RW40 74	280	2 x 3NA3 354-6	2 x 355	3	3RT10 66-6A.36
3RW40 75	356	2 x 3NA3 365-6	2 x 500	3	3RT10 75-6A.36
3RW40 76	432	2 x 3NA3 365-6	2 x 500	3	3RT10 76-6A.36

<sup>1)</sup> The types of coordination are explained in more detail in Catalog LV 1, "Load Feeders, Motor Starters and Soft Starters" → "Fuseless Load Feeders".

# 3RW Soft Starters

## 3RW40 for standard applications

Fused version with 3NE1 SITOP fuses (semiconductor and line protection)

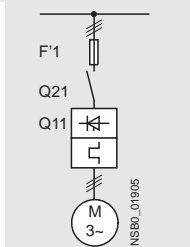

Soft starters		All-range fuses			Line contactors
Q11 Type	Rated current A	F'1 Type	Rated current A	Size	(optional) Q21
<b>Type of coordination 2<sup>1)</sup>: <math>I_q = 65 \text{ kA at } 600 \text{ V } +5 \%</math></b>					
<b>3RW40 24</b>	12.5	3NE1 814-0	20	000	3RT10 24
<b>3RW40 26</b>	25	3NE1 803-0	35	000	3RT10 26
<b>3RW40 27</b>	32	3NE1 020-2	80	00	3RT10 34
<b>3RW40 28</b>	38	3NE1 020-2	80	00	3RT10 35
<b>3RW40 36</b>	45	3NE1 020-2	80	00	3RT10 36
<b>3RW40 37</b>	63	3NE1 820-0	80	000	3RT10 44
<b>3RW40 38</b>	72	3NE1 820-0	80	000	3RT10 45
<b>3RW40 46</b>	80	3NE1 021-0	100	00	3RT10 45
<b>3RW40 47</b>	106	3NE1 022-0	125	00	3RT10 46
<b>3RW40 55</b>	134	3NE1 227-2	250	1	3RT10 55-6A.36
<b>3RW40 56</b>	162	3NE1 227-2	250	1	3RT10 56-6A.36
<b>3RW40 73</b>	230	3NE1 331-2	350	2	3RT10 65-6A.36
<b>3RW40 74</b>	280	3NE1 333-2	450	2	3RT10 66-6A.36
<b>3RW40 75</b>	356	3NE1 334-2	500	2	3RT10 75-6A.36
<b>3RW40 76</b>	432	3NE1 435-2	560	3	3RT10 76-6A.36

<sup>1)</sup> The types of coordination are explained in more detail in Catalog LV 1, "Load Feeders, Motor Starters and Soft Starters" —> "Fuseless Load Feeders".

The type of coordination "2" refers only to soft starters, not to any components in the feeder.

**Fused version with 3NE3 SITOR fuses** (semiconductor protection by fuse, line and overload protection by motor starter protector; alternatively, installation with contactor and overload relay possible)

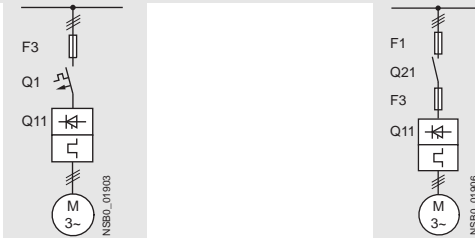

Soft starters		Semiconductor fuses, minimum			Semiconductor fuses, maximum			Semiconductor fuses, minimum		
Q11 Type	Rated current A	F3 Type	Rated current A	Size	F3 Type	Rated current A	Size	F3 Type	Rated current A	Size
<b>Type of coordination "2"<sup>1)</sup>: I<sub>q</sub> = 65 kA at 600 V +5 %</b>										
3RW40 24	12.5	--	--	--	--	--	--	3NE4 101	32	0
3RW40 26	25	--	--	--	3NE3 221	100	1	3NE4 102	40	0
3RW40 27	32	--	--	--	3NE3 224	160	1	3NE4 118	63	0
3RW40 28	38	--	--	--	3NE3 224	160	1	3NE4 118	63	0
3RW40 36	45	--	--	--	3NE3 224	160	1	3NE4 120	80	0
3RW40 37	63	--	--	--	3NE3 225	200	1	3NE4 121	100	0
3RW40 38	72	3NE3 221	100	1	3NE3 227	250	1	--	--	--
3RW40 46	80	3NE3 222	125	1	3NE3 225	200	1	--	--	--
3RW40 47	106	3NE3 224	160	1	3NE3 231	350	1	--	--	--
3RW40 55	134	3NE3 227	250	1	3NE3 335	560	2	--	--	--
3RW40 56	162	3NE3 227	250	1	3NE3 335	560	2	--	--	--
3RW40 73	230	3NE3 232-0B	400	1	3NE3 333	450	2	--	--	--
3RW40 74	280	3NE3 233	450	1	3NE3 336	630	2	--	--	--
3RW40 75	356	3NE3 335	560	2	3NE3 336	630	2	--	--	--
3RW40 76	432	3NE3 337-8	710	2	3NE3 340-8	900	2	--	--	--

Soft starters		Semiconductor fuses max.			Semiconductor fuses min.			Semiconductor fuses max.			Cylindrical fuses	
Q11 Type	Rated current A	F3 Type	Rated current A	Size	F3 Type	Rated current A	Size	F3 Type	Rated current A	Size	F3 Type	Rated current A
<b>Type of coordination "2"<sup>1)</sup>: I<sub>q</sub> = 65 kA at 600 V +5 %</b>												
3RW40 24	12.5	3NE4 117	50	0	3NE8 015-1	25	00	3NE8 017-1	50	00	3NC2 240	40
3RW40 26	25	3NE4 117	50	0	3NE8 017-1	50	00	3NE8 021-1	100	00	3NC2 263	63
3RW40 27	32	3NE4 118	63	0	3NE8 018-1	63	00	3NE8 022-1	125	00	3NC2 280	80
3RW40 28	38	3NE4 118	63	0	3NE8 020-1	80	00	3NE8 024-1	160	00	3NC2 280	80
3RW40 36	45	3NE4 120	80	0	3NE8 020-1	80	00	3NE8 024-1	160	00	3NC2 280	80
3RW40 37	63	3NE4 121	100	0	3NE8 021-1	100	00	3NE8 024-1	160	00	--	--
3RW40 38	72	--	--	--	3NE8 022-1	125	00	3NE8 024-1	160	00	--	--
3RW40 46	80	--	--	--	3NE8 022-1	125	00	3NE8 024-1	160	00	--	--
3RW40 47	106	--	--	--	3NE8 024-1	160	00	3NE8 024-1	160	00	--	--
3RW40 55	134	--	--	--	--	--	--	--	--	--	--	--
3RW40 56	162	--	--	--	--	--	--	--	--	--	--	--
3RW40 73	230	--	--	--	--	--	--	--	--	--	--	--
3RW40 74	280	--	--	--	--	--	--	--	--	--	--	--
3RW40 75	356	--	--	--	--	--	--	--	--	--	--	--
3RW40 76	432	--	--	--	--	--	--	--	--	--	--	--

Soft starters		Line contactors (optional)	Motor starter protectors/circuit breakers				Line protection, maximum		
Q11 Type	Rated current A	Q21 Type	400 V +10 % Q1 Type	Rated current A	575 V +10 % Q1 Type	Rated current A	F1 Type	Rated current A	Size
<b>Type of coordination "2"<sup>1)</sup>: I<sub>q</sub> = 65 kA at 600 V +5 %</b>									
3RW40 24	12.5	3RT10 24	3RV1 031-4AA10	55	--	--	3NA3 820-6	50	00
3RW40 26	25	3RT10 26	3RV1 031-4DA10	55	--	--	3NA3 822-6	63	00
3RW40 27	32	3RT10 34	3RV1 031-4EA10	55	--	--	3NA3 824-6	80	00
3RW40 28	38	3RT10 35	3RV1 031-4FA10	55	--	--	3NA3 824-6	80	00
3RW40 36	45	3RT10 36	3RV1 031-4GA10	20	--	--	3NA3 130-6	100	1
3RW40 37	63	3RT10 44	3RV1 041-4JA10	20	--	--	3NA3 132-6	125	1
3RW40 38	72	3RT10 45	3RV1 041-4KA10	20	--	--	3NA3 132-6	125	1
3RW40 46	80	3RT10 45	3RV1 041-4LA10	11	--	--	3NA3 136-6	160	1
3RW40 47	106	3RT10 46	3RV1 041-4MA10	11	--	--	3NA3 136-6	160	1
3RW40 55	134	3RT10 55-6A.36	3VL3 720-1DC36	200	3VL3 720-1DC36	200	3NA3 244-6	250	2
3RW40 56	162	3RT10 56-6A.36	3VL3 720-1DC36	200	3VL3 720-1DC36	200	3NA3 244-6	250	2
3RW40 73	230	3RT10 65-6A.36	3VL4 731-1DC36	315	3VL5 731-1DC36	315	2 x 3NA3 354-6	2 x 355	3
3RW40 74	280	3RT10 66-6A.36	3VL4 731-1DC36	315	3VL5 731-1DC36	315	2 x 3NA3 354-6	2 x 355	3
3RW40 75	356	3RT10 75-6A.36	3VL4 740-1DC36	400	3VL5 740-1DC36	400	2 x 3NA3 365-6	2 x 500	3
3RW40 76	432	3RT10 76-6A.36	3VL5 750-1DC36	500	3VL5 750-1DC36	500	2 x 3NA3 365-6	2 x 500	3

<sup>1)</sup> The types of coordination are explained in more detail in Catalog LV 1, "Load Feeders, Motor Starters and Soft Starters" → "Fuseless Load Feeders". The type of coordination "2" refers only to soft starters, not to any components in the feeder.

# 3RW Soft Starters

## 3RW40 for standard applications

### Characteristic curves

Motor protection tripping characteristics for 3RW40 (with symmetry)

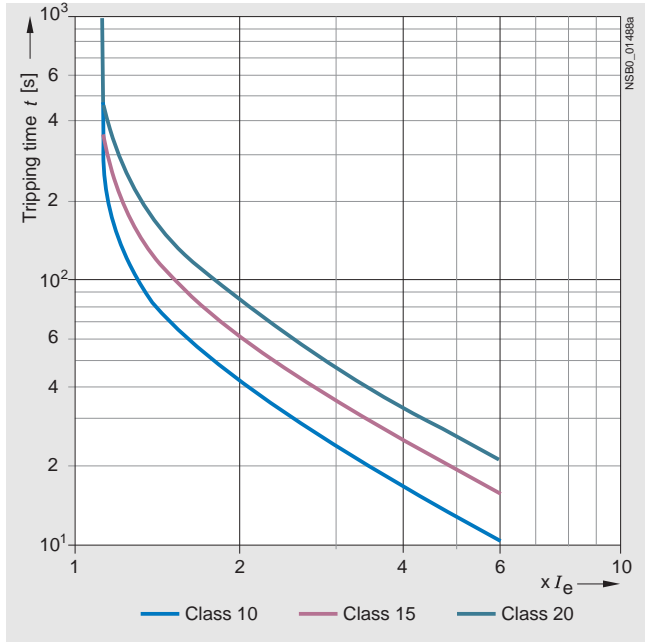

Motor protection tripping characteristics for 3RW40 (with asymmetry)

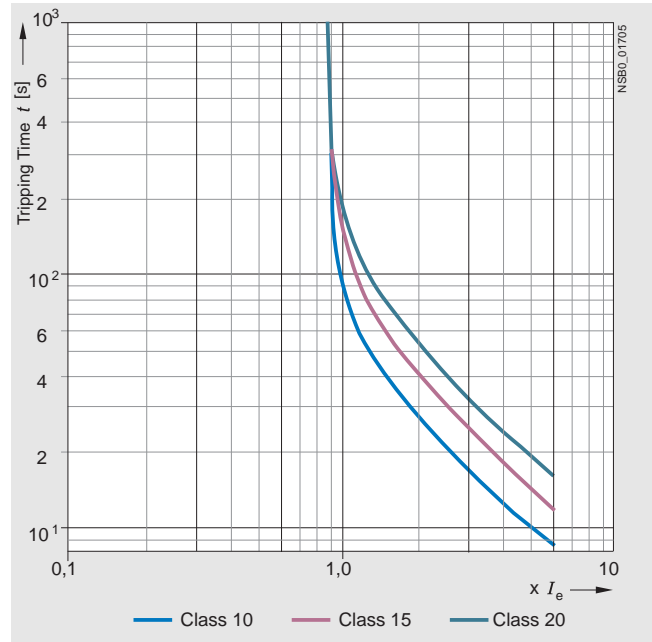

Permissible installation height

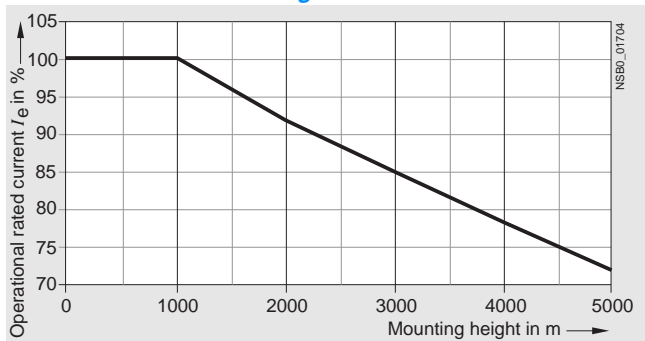

At an installation height above 2000 m, the max. permissible operational voltage is reduced to 460 V.

6

## More information

**Application examples for normal starting (Class 10)****Normal starting Class 10** (up to 20 s with 350 %  $I_{n \text{ motor}}$ ).

The soft starter rating can be selected to be as high as the rating of the motor used.

Application		Conveyor belt	Roller conveyor	Compressor	Small fan	Pump	Hydraulic pump
<b>Starting parameters</b>							
• Voltage ramp and current limiting							
- starting voltage	%	70	60	50	40	40	40
- starting time	s	10	10	10	10	10	10
- current limit value		$5 \times I_M$	$5 \times I_M$	$4 \times I_M$	$4 \times I_M$	$4 \times I_M$	$4 \times I_M$
<b>Ramp-down time</b>	s	5	5	0	0	10	0

**Application examples for heavy starting (Class 20)****Heavy starting Class 20** (up to 40 s with 350 %  $I_{n \text{ motor}}$ ).

The soft starter has to be selected at least one rating class higher than the motor used.

Application		Stirrer	Centrifuge
<b>Starting parameters</b>			
• Voltage ramp and current limiting			
- starting voltage	%	40	40
- starting time	s	20	20
- current limit value		$4 \times I_M$	$4 \times I_M$
<b>Ramp-down time</b>		0	0

Note:

These tables present sample set values and device sizes. They are intended only for the purposes of information and are not binding. The set values depend on the application in question and must be optimized during start-up.

The soft starter dimensions should be checked where necessary with the Win-Soft Starter software or with the help of Technical Assistance.

# 3RW Soft Starters

## 3RW40 for standard applications

### Configuration

The 3RW solid-state soft starters are designed for easy starting conditions. In the event of deviating conditions or increased switching frequency, it may be necessary to choose a larger device. For accurate dimensioning, use the Win-Soft Starter selection and simulation program.

Where long starting times are involved, the integrated solid-state overload relay for heavy starting should not be disconnected. PTC sensors are recommended. This also applies for the smooth ramp-down because during the ramp-down time an additional current loading applies in contrast to free ramp-down.

In the case of high switching frequencies in S4 mode, Siemens recommends the use of PTC sensors. For corresponding device versions with integrated thermistor motor protection or separate thermistor evaluation devices see Catalog LV 1.

In the motor feeder between the SIRIUS 3RW soft starter and the motor, no capacitive elements are permitted (e.g. no reactive-power compensation equipment). In addition, neither static systems for reactive-power compensation nor dynamic PFC (Power Factor Correction) must be operated in parallel during starting and ramp-down of the soft starter. This is important to prevent faults arising on the compensation equipment and/or the soft starter.

All elements of the main circuit (such as fuses and controls) should be dimensioned for direct starting, following the local short-circuit conditions. Fuses, controls and overload relays must be ordered separately. Please observe the maximum switching frequencies specified in the technical specifications.

#### Note:

*When induction motors are switched on, voltage drops occur as a rule on starters of all types (direct starters, wye-delta starters, soft starters). The infeed transformer must always be dimensioned such that the voltage dip when starting the motor remains within the permissible tolerance. If the infeed transformer is dimensioned with only a small margin, it is best for the control voltage to be supplied from a separate circuit (independently of the main voltage) in order to avoid the potential switching off of the soft starter.*

### Power electronics schematic circuit diagram

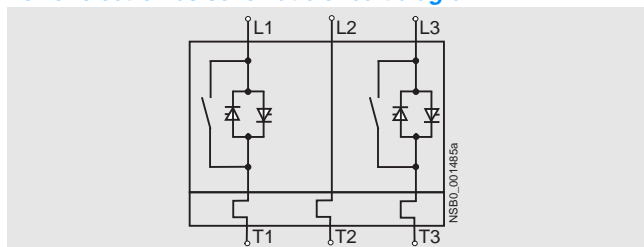

A bypass contact system and solid-state overload relay are already integrated in the 3RW40 soft starter and therefore do not have to be ordered separately.

### Status graphs

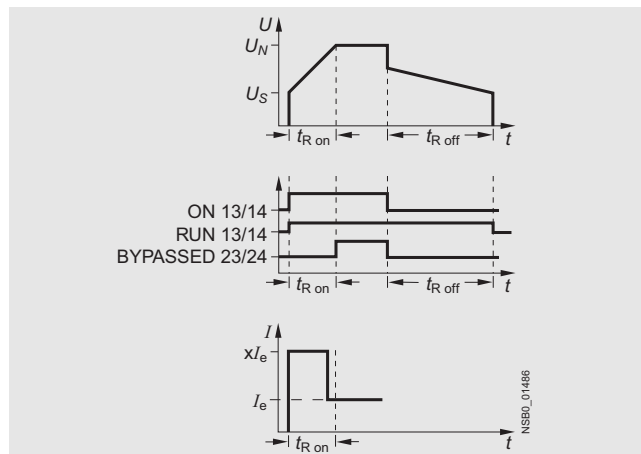

### Win-Soft Starter selection and simulation program

With this software, you can simulate and select all Siemens soft starters, taking into account various parameters such as mains properties, motor and load data, and special application requirements.

The software is a valuable tool, which makes complicated, lengthy manual calculations for determining the required soft starters superfluous.

You can order the CD-ROM under the following order number:

Order No. E20001-D1020-P302-V2-7400.

More information can be found on the Internet at <http://www.siemens.com/softstarter>

## Dimensional drawings

## 3RW30 for standard applications

3RW30 1. ... 3RW30 4.

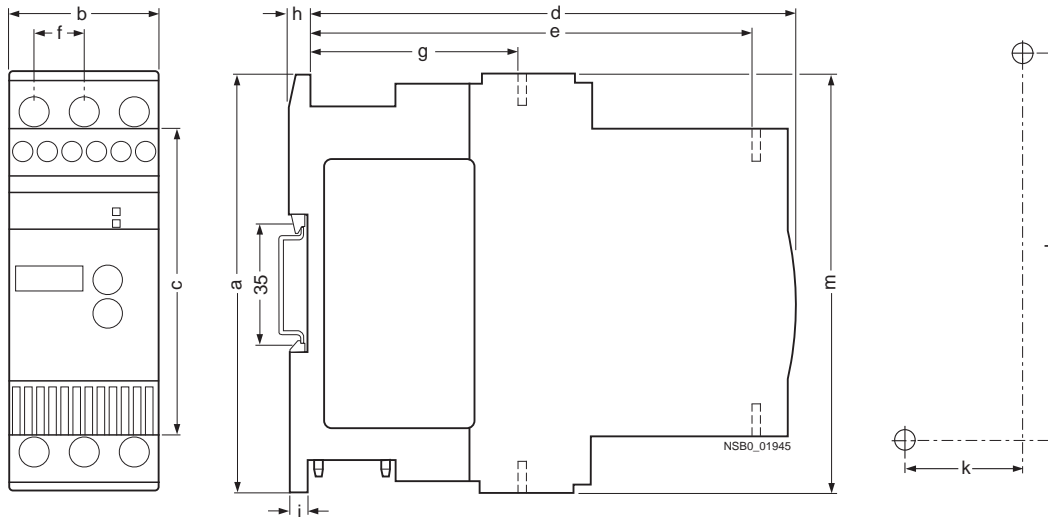

Type/Dimension (mm)	a	b	c	d	e	f	g	h	i	k	l	m
3RW30 1.-1.	95	45	62	146	126	14.4	63	5	6.5	35	85	95
3RW30 1.-2.	95	45	62	146	126	14.4	63	5	6.5	35	85	117.2
3RW30 2.-1.	125	45	92	146	126	14.4	63	5	6.5	35	115	125
3RW30 2.-2.	125	45	92	146	126	14.4	63	5	6.5	35	115	150
3RW30 3.	160	55	110	163	140	18	63	5	6.5	30	150	144
3RW30 4.	170	70	110	181	158	22.5	85	5	10	60	160	160

Distances to grounded parts (mm)	Lateral	Top	Bottom	Fixing screws	Tightening torques (Nm)
3RW30 1.	5	60	40	M4	1
3RW30 2.	5	60	40	M4	1
3RW30 3.	30	60	40	M4	1
3RW30 4.	30	60	40	M4	2

## 3RW30 03-1. (screw terminals)

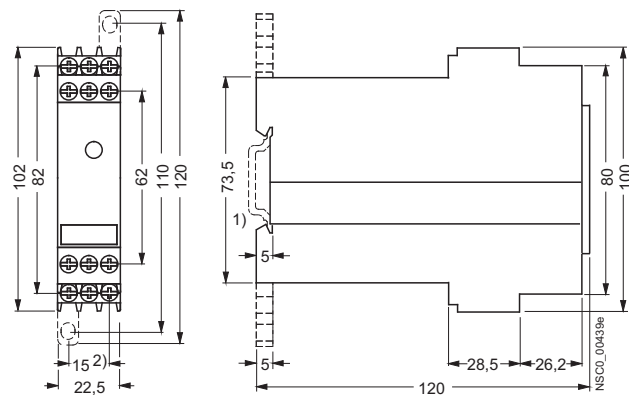

## 3RW30 03-2. (spring-loaded terminals)

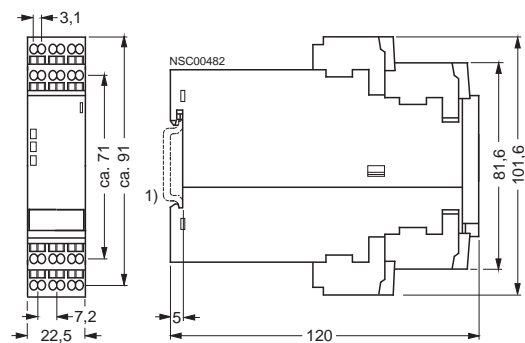

1) For mounting onto standard mounting rail TH 35 according to EN 60715.

2) Dimension for screw mounting.  
Screw mounting with two 3RP1 903 push-in lugs per 3RW30 03 device.

# 3RW Soft Starters

## Project planning aids

### 3RW40 for standard applications

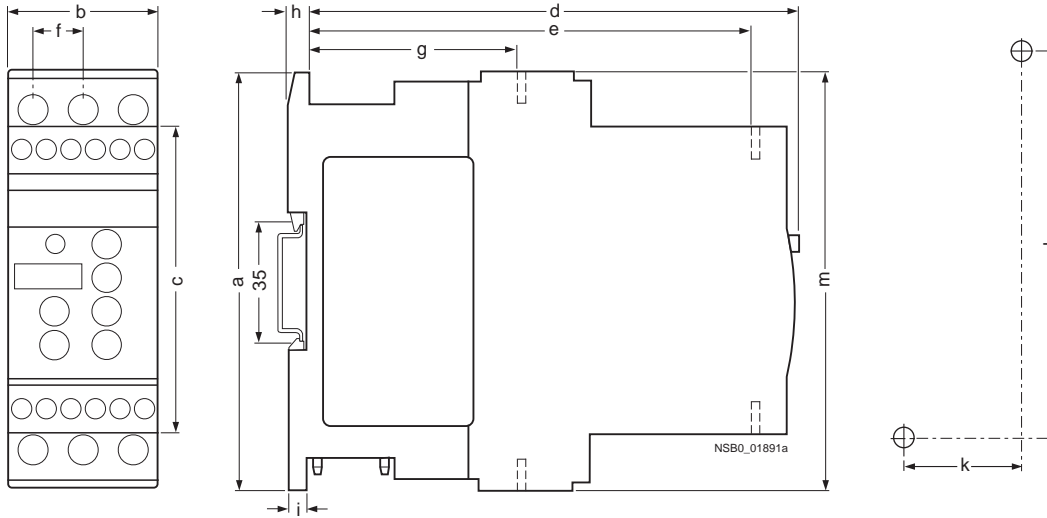

Type/Dimension (mm)	a	b	c	d	e	f	g	h	i	k	l	m
3RW40 2.-1.	125	45	92	149	126	14.4	63	5	6.5	35	115	125
3RW40 2.-2.	125	45	92	149	126	14.4	63	5	6.5	35	115	150
3RW40 3.	170	55	110	165	140	18	63	5	6.5	30	150	144
3RW40 4.	170	70	110	183	158	22.5	85	5	10	60	160	160

Distances to grounded parts (mm)	Lateral	Top	Bottom	Fixing screws	Tightening torques (Nm)
3RW40 2.	5	60	40	M4	1
3RW40 3.	30	60	40	M4	1
3RW40 4.	30	60	40	M4	2

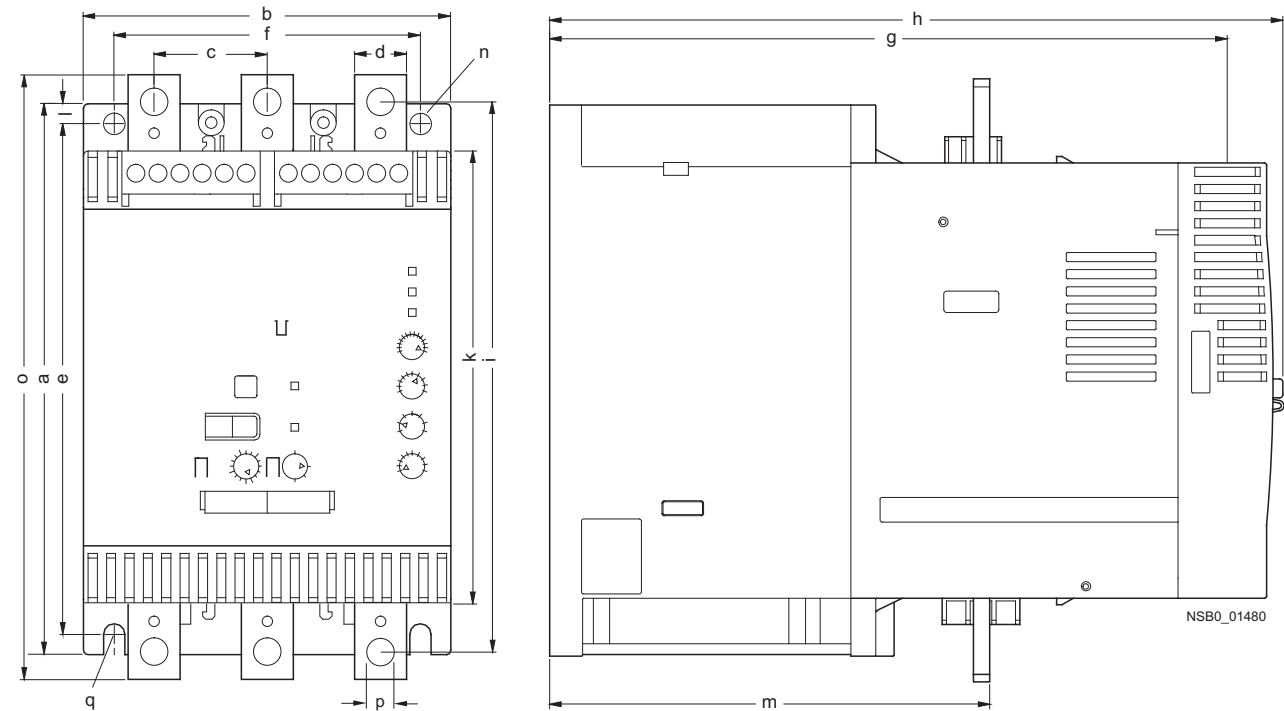

Type/Dimension (mm)	a	b	c	d	e	f	g	h	i	k	l	m	N	o	p	q
3RW40 5.	180	120	37	17	167	100	223	250	180	148	6.5	153	7	198	9	M6, 10 Nm
3RW40 7.	210	160	48	25	190	140	240	278	205	166	10	166	9	230	11	M8, 15 Nm

6



## Schematics

## 3RW30 .. connection examples for control circuit

## Control using switches

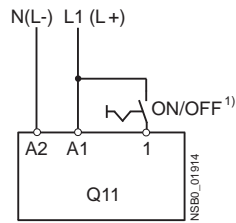

## Automatic mode

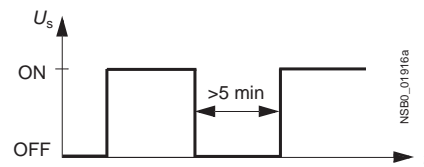
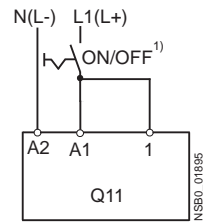

## Control by pushbutton

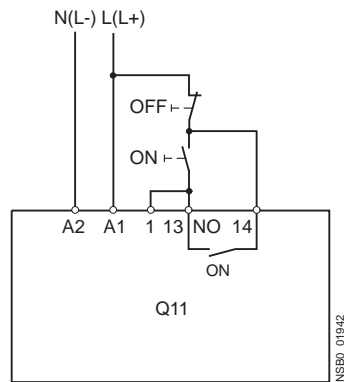

## Control of a main contactor

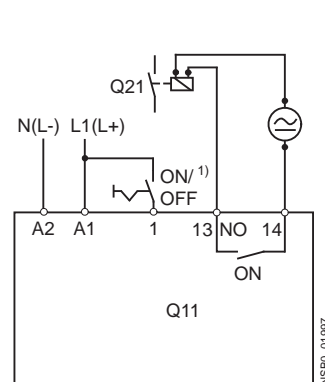
3RW30 connection examples for main circuit<sup>2)</sup>

## 3RW30 – 3-phase motor with 3NA/3NE fuse

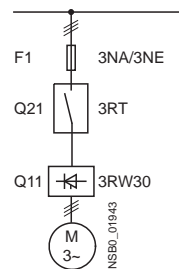

## 3RV motor starter protectors

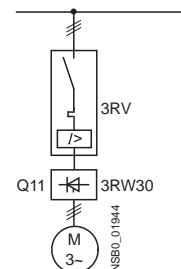
<sup>1)</sup> Caution: Risk of restarting

When operating with a switch (ON/OFF) a new, automatic restart will take place automatically if the start command is still active at terminal 1.

<sup>2)</sup> As an alternative, the motor feeder can also be installed as a fuseless or as a fused version. [Fuse and switching device coordination, see "Technical specifications"](#).

The wiring diagrams are provided only as examples.

# 3RW Soft Starters

## Project planning aids

### Connection examples of 3RW40 2. ... 3RW40 4. for control circuit

#### Control using switches

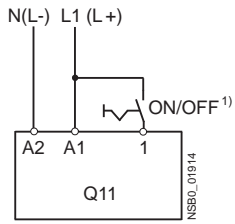

#### Automatic mode

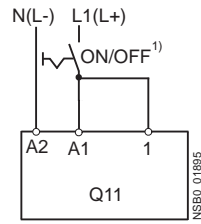

#### Control by remote reset

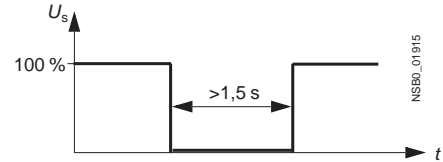
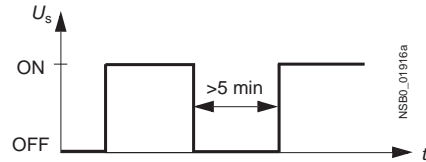
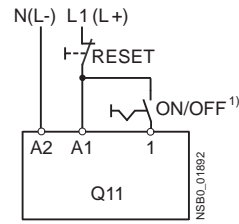

#### Control of 3RW40 2. ... 3RW40 4. by pushbutton

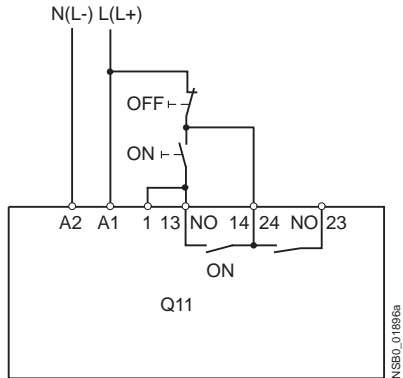

#### Control of a main contactor

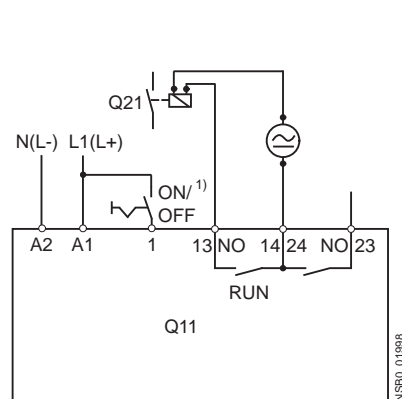

#### Connection example of 3RW40 2. ... 3RW40 4. for PTC sensors (thermistor motor protection)

##### Thermoclick

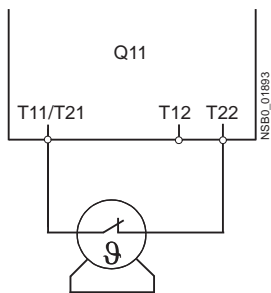

##### PTC type A

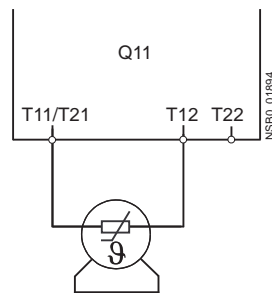

#### 1) Caution: Risk of restarting

When operating with a switch (ON/OFF) a new, automatic restart will take place automatically if the start command is still active at terminal 1.

6

## Project planning aids

### Connection examples of 3RW40 5. and 3RW40 7. for control circuit

#### Control by switch using internal 24 V DC supply

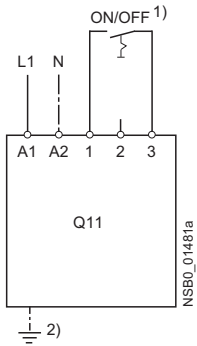

#### External power supply

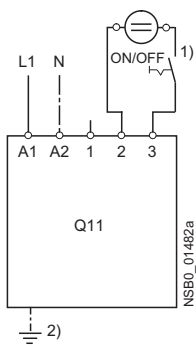

#### Control by pushbutton

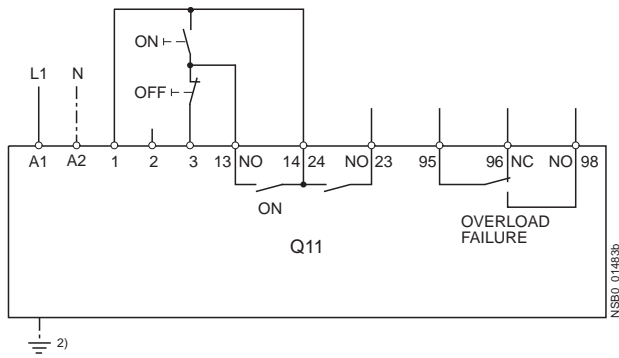

#### Control of a main contactor

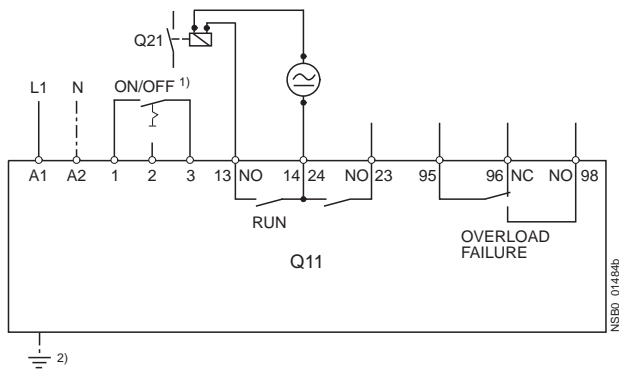

#### 1) Caution: Risk of restarting

When operating with a switch (ON/OFF) a new, automatic restart will take place automatically if the start command is still active at terminal 3.

2) Grounding necessary for fan connection to 3RW40 5...

3) As an alternative, the motor feeder can also be installed as a fuseless or as a fused version. [Fuse and switching device coordination, see "Technical specifications"](#).

The wiring diagrams are provided only as examples.

### 3RW40 connection examples for main circuit<sup>3)</sup>

#### 3RW40 – 3-phase motor with 3NA/3NE fuse

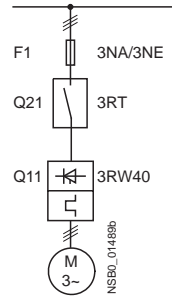

#### 3RV/3VL motor starter protectors

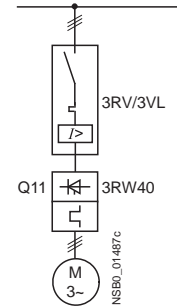

# 3RW Soft Starters

Notes

6



## Industry Automation, Motion Control and Electrical Installation Technology

Further information can be obtained from our branch offices listed in the appendix or at [www.siemens.com/automation/partner](http://www.siemens.com/automation/partner)

<b>Automation and Drives</b>	<i>Catalog</i>	<b>Industrial Communication for Automation and Drives</b>	<i>Catalog</i> IK PI
Interactive catalog on CD-ROM and on DVD			
• The Offline Mall of Automation and Drives	CA 01		
<b>Automation Systems for Machine Tools</b>		<b>Low-Voltage</b>	
SINUMERIK & SIMODRIVE	NC 60	Controls and Distribution – SIRIUS, SENTRON, SIVACON	LV 1
SINUMERIK & SINAMICS	NC 61	Controls and Distribution – Technical Information SIRIUS, SENTRON, SIVACON	LV 1 T
<b>Drive Systems</b>		SIDAC Reactors and Filters	LV 60
<u>Variable-Speed Drives</u>		SIVENT Fans	LV 65
SINAMICS G110/SINAMICS G120	D 11.1	SIVACON 8PS Busbar Trunking Systems	LV 70
Inverter Chassis Units			
SINAMICS G120D			
Distributed Frequency Inverters			
SINAMICS G130 Drive Converter Chassis Units, SINAMICS G150 Drive Converter Cabinet Units	D 11		
SINAMICS GM150/SINAMICS SM150 Medium-Voltage Converters	D 12		
SINAMICS S120 Drive Converter Systems	D 21.1	<b>Motion Control System SIMOTION</b>	PM 10
SINAMICS S150 Drive Converter Cabinet Units	D 21.3		
Asynchronous Motors Standardline	D 86.1	<b>Process Instrumentation and Analytics</b>	
Synchronous Motors with Permanent-Magnet Technology, HT-direct	D 86.2	Field Instruments for Process Automation	FI 01
DC Motors	DA 12	Measuring Instruments for Pressure, Differential Pressure, Flow, Level and Temperature, Positioners and Liquid Meters	
SIMOREG DC MASTER 6RA70 Digital Chassis Converters	DA 21.1	<i>PDF: Indicators for panel mounting</i>	MP 12
SIMOREG K 6RA22 Analog Chassis Converters	DA 21.2	SIREC Recorders and Accessories	MP 20
<i>PDF: SIMOREG DC MASTER 6RM70 Digital Converter Cabinet Units</i>	DA 22	SIPART, Controllers and Software	MP 31
SIMOVERT PM Modular Converter Systems	DA 45	SIWAREX Weighing Systems	WT 01
SIEMOSYN Motors	DA 48	Continuous Weighing and Process Protection	WT 02
MICROMASTER 420/430/440 Inverters	DA 51.2	Process Analytical Instruments	PA 01
MICROMASTER 411/COMBIMASTER 411	DA 51.3	<i>PDF: Process Analytics, Components for the System Integration</i>	PA 11
SIMOVERT MASTERDRIVES Vector Control	DA 65.10		
SIMOVERT MASTERDRIVES Motion Control	DA 65.11	<b>SIMATIC Industrial Automation Systems</b>	
Synchronous and asynchronous servomotors for SIMOVERT MASTERDRIVES	DA 65.3	SIMATIC PCS Process Control System	ST 45
SIMODRIVE 611 universal and POSMO	DA 65.4	Products for Totally Integrated Automation and Micro Automation	ST 70
<u>Low-Voltage Three-Phase-Motors</u>		SIMATIC PCS 7 Process Control System	ST PCS 7
IEC Squirrel-Cage Motors	D 81.1	Add-ons for the SIMATIC PCS 7 Process Control System	ST PCS 7.1
IEC Squirrel-Cage Motors · New Generation 1LE1	D 81.1 N	Migration solutions with the SIMATIC PCS 7 Process Control System	ST PCS 7.2
<i>PDF: Geared Motors</i>	M 15	pc-based Automation	ST PC
<u>Automation Systems for Machine Tools SIMODRIVE</u>	NC 60	SIMATIC Control Systems	ST DA
• Main Spindle/Feed Motors			
• Converter Systems SIMODRIVE 611/POSMO		<b>SIMATIC Sensors</b>	
<u>Automation Systems for Machine Tools SINAMICS</u>	NC 61	Sensors for Factory Automation	FS 10
• Main Spindle/Feed Motors			
• Drive System SINAMICS S120		<b>Systems Engineering</b>	
<u>Drive and Control Components for Hoisting Equipment</u>	HE 1	Power supplies SITOP power	KT 10.1
		System cabling SIMATIC TOP connect	KT 10.2
<b>Electrical Installation Technology</b>			
<i>PDF: ALPHA Small Distribution Boards and Distribution Boards, Terminal Blocks</i>	ETA 1	<b>System Solutions</b>	
<i>PDF: ALPHA 8HP Molded-Plastic Distribution System</i>	ETA 3	Applications and Products for Industry are part of the interactive catalog CA 01	
<i>PDF: BETA Low-Voltage Circuit Protection</i>	ET B1		
<i>PDF: DELTA Switches and Socket Outlets</i>	ET D1	<b>TELEPERM M Process Control System</b>	
GAMMA Building Controls	ET G1	<i>PDF: AS 488/TM automation systems</i>	PLT 112
<b>Human Machine Interface Systems SIMATIC HMI</b>	ST 80		

*PDF: These catalogs are only available as pdf files.*

## Get more information

Low-Voltage Controls and Distribution  
[www.siemens.com/lowvoltage](http://www.siemens.com/lowvoltage)

Siemens AG  
Industry Sector  
Postfach 4848  
90327 NÜRNBERG  
GERMANY

Subject to change without prior notice  
PDF only: (E86060-K1002-A261-A1-7600)  
KG 0208 50 En / 803029  
© Siemens AG 2008

[www.siemens.com/automation](http://www.siemens.com/automation)

The information provided in this catalog contains descriptions or characteristics of performance which in case of actual use do not always apply as described or which may change as a result of further development of the products. An obligation to provide the respective characteristics shall only exist if expressly agreed in the terms of contract. Availability and technical specifications are subject to change without notice.

All product designations may be trademarks or product names of Siemens AG or supplier companies whose use by third parties for their own purposes could violate the rights of the owners.