

KATALOG/CATALOGUE A

2014/2015

osmont®

I.

PRÍSAZENÁ SVÍTIDLA SE STÍNÍTKY ZE SKLA TRIPLEX OPÁL
 SURFACE MOUNTED LAMPS WITH TRIPLEX OPAL GLASS SHADES
 НАКЛАДНЫЕ СВЕТИЛЬНИКИ СО СВЕТОРАССЕИВАТЕЛЯМИ ИЗ
 ТРЕХСЛОЙНОГО ОПАЛОВОГО СТЕКЛА ТРИПЛЕКС ОПАЛ
 WAND- UND DECKENLEUCHTEN MIT ABDECKUNGEN AUS TRIPLEX OPAL GLAS
 LUMINAIRE FIXE AVEC ABAT-JOUR EN VERRE OPALE TRIPLEX

A.
 PRÍSAZENÁ SVÍTIDLA
 SURFACE MOUNTED LAMPS
 НАКЛАДНЫЕ СВЕТИЛЬНИКИ
 WAND- UND DECKENLEUCHTEN
 LUMINAIRE FIXE



SATURN 1,2



NELA 4A



KIRA 1,2 / KIRA D1,2



AURA P / CRATER P / DRACO P / EDNA P

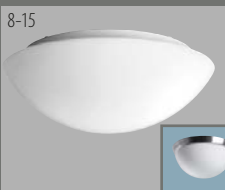

AURA 1-5, 9 / AURA DL 1-5



ALTAIR 1



LYRA 1,2



MIRA D



AURA T / CRATER T / DRACO T / EDNA T



CRATER 1-5 / CRATER DL1-5

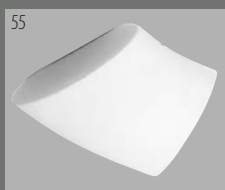

ALTAIR 2



NEVA 1,2



B.
 ZÁVĚSNÁ SVÍTIDLA
 PENDANT LIGHTING FITTINGS
 ПОДВЕСНЫЕ СВЕТИЛЬНИКИ
 PENDELLEUCHTEN
 LUMINAIRE SUSPENDU



MIRA R



DRACO 1-5 / DRACO DL1-5



GALAXIA



ALMA 1,2 / ALMA D 1,2



ADRIA 1-5 / L1-5 / S1-5



GALAXIA L



AURA 6-11 / AURA D 6-8,10,11

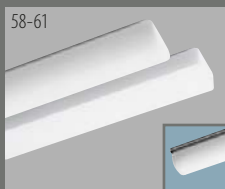

SYLVIA 1,2 / SYLVIA D1,2



PYRAMUS 1,2



ASTRA / ASTRA L / ASTRA S



C.
 STOLNÍ LAMPY
 TABLE LAMPS
 НАСТОЛЬНЫЕ ЛАМПЫ
 TISCHLAMPEN
 LAMPE DE BUREAU



ELSA 1-6 / ELSA D1-4



FLORA 1-5



PYRAMUS 3



DANA E 1,2



ACTOR



EDNA 1-5



JENA 1,2



ORCUS DK



DANTE 1,2

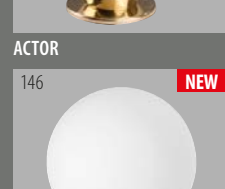

BIANCA 1,2,3



LINA 1,2,3,6 / LINA 4,5

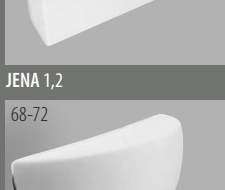

NELA 1,2,3 / NELA DL 1,2,3



STYX 1,2,3,4



SATURN 1,2



ADELE



ADELE



SVÍTIDLA S PLASTOVÝMI STÍNÍTKY
LIGHTING WITH PLASTIC SHADES
СВЕТИЛЬНИКИ С ПЛАСТИКОВЫМИ СВЕТОРАСSEИВАТЕЛЯМИ
LEUCHTEN MIT KUNSTSTOFFABDECKUNGEN
LUMINAIRE AVEC ABAT-JOUR PLASTIQUE

A.

PŘISAZENÁ SVÍTIDLA
SURFACE MOUNTED LAMPS
НАКЛАДНЫЕ СВЕТИЛЬНИКИ
WAND- UND DECKENLEUCHTEN
APPLICATION DES LUMINAIRES:



TITAN 1a, 1, 2, 3, 4, 5



DELIA 1, 2, 3



TILIA 1, 2



VICIA



TITAN 13



VEGA

B.

ZÁVĚSNÁ SVÍTIDLA
PENDANT LIGHTING FITTINGS
ПОДВЕСНЫЕ СВЕТИЛЬНИКИ
RENDELLEUCHTEN
LUMINAIRES SUSPENDUS



ISIS 3, 4 / ISIS L 3, 4 / ISIS S 3, 4



TITAN T 2, 3



DELIA T 2, 3



VICIA T



TITAN L 4, 5

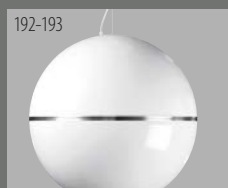

VELA L

C.

PRŮMYŠLOVÁ SVÍTIDLA
INDUSTRIAL LIGHTING
ПРОМЫШЛЕННЫЕ СВЕТИЛЬНИКИ
INDUSTRIELEUCHTEN
LUMINAIRES INDUSTRIELS



ELEKTRA 1, 2



ELEKTRA 3, 3K, 3L



ELEKTRA 4, 5



ELEKTRA 6



META



POPISY
DESCRIPTIONS
ОПИСАНИЕ
BESCHREIBUNGEN
DESCRIPTIONS

- a) POPISY LED SVÍTIDEL
- b) POPIS SENZORŮ
- c) POPIS BEZDRÁTOVÉHO OVLÁDÁNÍ
- d) PŘEVOD VÝKONU ZDROJŮ
- e) PŘEHLED POUŽITÍ KOMPAKTNÍCH ZDROJŮ E27
- f) PŘEHLED PIKTOGRAMŮ

- a) DESCRIPTIONS OF LED LIGHTING FITTINGS
- b) DESCRIPTION OF SENSOR
- c) DESCRIPTION OF WIRELESS CONTROL
- d) VIEW OF SOURCES POWER
- e) VIEW OF USING COMPACT LAMPS E27
- f) VIEW OF PICTOGRAMS

- a) ОПИСАНИЕ СВЕТОДИОДНЫХ СВЕТИЛЬНИКОВ
- b) ОПИСАНИЕ ДАТЧИКОВ ДВИЖЕНИЯ
- c) ОПИСАНИЕ ДИСТАНЦИОННОГО УПРАВЛЕНИЯ
- d) ПЕРЕВОД МОЩНОСТИ ИСТОЧНИКОВ СВЕТА
- e) ОБЗОР ИСПОЛЬЗОВАНИЯ КОМПАКТНЫХ ЛАМП E27
- f) ОБЗОР ПИКТОГРАММ

- a) LED-LEUCHTENBESCHREIBUNGEN
- b) SENSORBESCHREIBUNG
- c) BESCHREIBUNG DER DRAHTLOSEN BEDIENUNG
- d) LEISTUNGSÜBERTRAGUNG DER LICHTQUELLEN
- e) ÜBERSICHT ÜBER DEN EINSATZ DER KOMPAKTQUELLEN E27
- f) ÜBERSICHT ÜBER DIE PIKTOGRAMME

- a) DESCRIPTION DES LUMINAIRES LED
- b) DESCRIPTION DU CAPTEUR
- c) DESCRIPTION DE LA COMMANDE SANS FIL
- d) TRANSFERT DE PERFORMANCE DES SOURCES
- e) PRESENTATION DE L'UTILISATION DES SOURCES COMPACTES E27
- f) PRESENTATION DES PIKTOGRAMMES



CZ Úvod

Firma Osmont, s.r.o. se zabývá již od roku 1991 výrobou svítidel, která jsou určená pro osvětlování interiéru i exteriéru.

Hlavní nabídkou jsou svítidla s ručně vyráběnými stíničky z třívrstvého opálového skla. Výrobní program tvoří svítidla přisazená, tzn. stropní a nástěnná, závěsná a nově i stolní lampy

V celém sortimentu je nabídnuta široká škála světelných zdrojů.

Svítidla mohou být vybavena i vysokofrekvenčními senzory nebo nouzovými jednotkami.

Popis svítidel

Montury	- ocelový plech upravený práškovým lakováním - IP20, IP41, IP43, IP44 - polycarbonátový výlisek - IP43, IP65, tř. II, - polypropylenový výlisek - IP20, IP53, IP54, tř. II,
Stínička	- třívrstvé, ručně vyráběné sklo TRIPLEX OPÁL s matovaným povrchem o průměru 200 - 600mm - stínička z číreho nebo opálového polycarbonátu, polymethylmetakrylátu nebo polyetylenu
Závěsy	- tyčové (ocelová trubka o průměru 10mm, bílý lak nebo nerez) - lankové (nerezové lanko s kovovými díly v laku nebo nerez, transparentní kabel) - kabelové
Držení stíničky	- sklapovací dvoupolohové držáky - bajonetové držení - šroubkové držení
Světelné zdroje	- žárovky, zářivky, LED moduly
Vysokofrekvenční senzor	- pohybové čidlo je integrováno uvnitř svítidla ve vybraných typech
Nouzový modul	- je zabudovaný uvnitř svítidla a umožňuje provoz jak pouze v nouzovém režimu tak i v kombinovaném režimu pro trvalé svícení.
Montáž	- na stěnu nebo na strop
Použití	- bytová výstavba, společenské prostory, kanceláře, průmyslové prostory

Použití popisů v katalogu:

Záhlaví tabulek:

Kód	- číselné označení pro objednávání
Typ	- typové označení svítidel
W	- výkon a počet zdrojů, (u žárovkových maximální povolený výkon)
Objímka	- typ a počet použitých objímek
T	- doba svícení svítidla v nouzovém režimu (v hodinách)

Symboly a údaje v tabulkách

A	- žárovkové (E27, E14)
VVG	- zářivkové svítidlo s magnetickým předřadníkem
EVG	- zářivkové svítidlo s elektronickým předřadníkem
DIM	- stmívatelné: 1-10V - svítidlo s analogově stmívatelným elektronickým předřadníkem DALI - svítidlo s digitálně stmívatelným elektronickým předřadníkem
S	SENZOROVÉ - svítidlo spínané integrovaným vysokofrekvenčním senzorem (podrobný popis na str. 206)
N	NOUZOVÉ - svítidlo pracující pouze v nouzovém režimu
NE	NOUZOVÉ KOMBINOVANÉ - svítidlo s elektronickým předřadníkem, které pracuje v normálním i nouzovém režimu
NES	NOUZOVÉ KOMBINOVANÉ SE SENZOREM - svítidlo s elektronickým předřadníkem a senzorem
LED	- svítidla se zdroji LED (podrobný popis na str.206)

EN Introduction

Osmont Company produces the indoor and outdoor lighting fittings since 1991. The lighting fittings with hand blown glasses Triplex opal are the main program.

Ceiling and wall lighting fittings, the pendant lighting fittings and now new table lamps belong to the production program.

There are wide variety of luminous sources offered in the entire product assortment. The lighting fittings can be equipped with high - frequency sensors or with emergency units.

DESCRIPTION OF THE LIGHTING FITTINGS

Fixture	- sheet steel modified by powder painting - IP20, IP 41, IP 44 - polycarbonate moulding - IP 43, class II, IP 65 - polypropylene moulding - IP 20, IP 53, IP 54, class II
Shade	- three layers, hand blown glass TRIPLEX OPAL matt with Φ 200-600 mm clear or opal polycarbonate shade, polymethylmetacrylate or polyethylen
Pendant	- bar (steel bar Φ 10mm, white paint or steel) - wire (steel wire pendant with metal paint or steel parts, transparent cable) Shade attachment - with folding two-step clamp holders, - with bayonet attachment - with screws attachment
Lighting sources	- incandescent lamps, saving compact fluorescent lamp, LED lamps
HF Sensor	- motion detector is situated inside the lighting fitting in chosen types
Emergency unit	- fixed inside the lighting fitting and enables to work in both modes, emergency and also in combined mode for permanent lightening
Assembly	- to the ceiling or on the wall
Applications	- housing constructions, cultural premises, offices, industrial premises

Used descriptions in the catalogues:

Table headline:

Code	- numerical labelling for orders
Type	- type labelling
W	- Power and source number (by incandescent lamps max. possible power)
Lamp holder	- type and number of used lamp holders
T	- Time of luminance in emergency mode (in hours)

Symbols and data in the tables

A	- Incandescent lamps (E27,E14)
VVG	- lighting fitting with fluorescent lamp with magnetic ballast equipped
EVG	- lighting fitting with fluorescent lamp with electronic ballast equipped
DIM	- 1-10 V lighting fitting with analogue dimmable electronic ballast - DALI - lighting fitting with digital electronic ballast
S	Sensor - lighting fitting switched by integrated HF sensor (detailed description on the page 206)
N	Emergency - lighting fitting working only in emergency mode
NE	Emergency combined - lighting fitting with electronic ballast, which works in both modes, normal and emergency
NES	Emergency combined - EVG - lighting fitting with electronic ballast and sensor
LED	- lighting fittings with LED modules (detailed description on the page 206)

RUS Введение

Компания Osmont s.r.o. начиная с 1991 года производит светильники, предназначенные для внутреннего и наружного освещения.

Основной упор делается на светильники, в которых светорассеиватель изготавливается вручную из трехслойного матового стекла (опаловое стекло).

Производственную программу составляют светильники накладные (т.е. настенные и потолочные), подвесные, а теперь еще и настольные лампы.

Предлагаемый ассортимент позволяет использовать разнообразные источники света. Светильники могут быть дополнительно оборудованы высокочастотными датчиками движения или блоками аварийного освещения.

Описание светильников

Освещение	- металлическое основание, обработанное порошковой краской - IP20, IP41, IP43, IP44 - прессованное основание из поликарбоната - IP43 класс II, IP65 - прессованное основание из полипропилена - IP20, IP53, IP54 класс II
Рассеиватель	- трехслойное стекло (TRIPLEX OPAL), изготовленное вручную с матированной поверхностью диаметром 200 - 600 мм - рассеиватель из прозрачного или молочного поликарбоната, полиметилакрилата или полиэтилена
Подвес	- жесткий (стальная трубка диаметром 10 мм, белый лак или хром) - гибкий (трос с металлическими элементами, варианты покрытия: лак или хром; прозрачный кабель) - кабельный
Крепление рассеивателя	- двухпозиционные фиксаторы - защелки - резьбовое соединение «байонет» - винтовое крепление
Источник света	- лампы накаливания, компактные люминесцентные лампы - светодиодные модули

Высокочастотный датчик движения - в выбранных моделях датчик движения установлен внутри светильника

Аварийный модуль – встраивается внутрь светильника и сохраняет работоспособность изделия как непосредственно в аварийном режиме, так и в комбинированном режиме для постоянного освещения.

Способ установки – настенный, потолочный
 Назначение – жилые помещения, общественные помещения, офисы, промышленные здания

Сокращения, используемые в каталоге:

Заглавия таблиц:

Код – цифровое обозначение необходимое для обработки заказа
 Тип – обозначение типа светильников
 W – мощность и количество ламп (для светильников с лампами накаливания указывается максимально разрешенная мощность)
 Патрон – тип и количество патронов
 T – время работы (свечения) светильника в аварийном режиме (в часах)

Символы и данные в таблицах

A – с лампой накаливания (E27, E14)
VVG – светильник с люминесцентной лампой и ЭМРА
EVG – светильник с люминесцентной лампой и ЭПРА
DIM – регулируемые: светильник регулируемый аналоговым сигналом 1-10V и ЭПРА
 DALI – светильник с цифровым управлением регулировки яркости свечения и ЭПРА
S СЕНСОРНЫЕ – светильники, включаемые с помощью встроенного высокочастотного датчика (подробное описание на стр.206)
N АВАРИЙНЫЕ – светильники, работающие только в режиме аварийного освещения
NE АВАРИЙНЫЕ КОМБИНИРОВАННЫЕ – светильник с ЭПРА, работающий в нормальном и аварийном режимах
NES АВАРИЙНЫЕ КОМБИНИРОВАННЫЕ – EVG – светильники с ЭПРА и датчиком движения
LED – светильники со светодиодами (подробное описание на стр.206)

DE Einleitung

Firma Osmond, s.r.o. beschäftigt sich schon seit 1991 mit der Herstellung von Leuchten, die für die Beleuchtung von Innen- und Außenräumen bestimmt sind.
 Das Hauptsortiment sind Leuchten aus dreischichtigem mundgeblasenem Glas TRIPLEX OPAL mit matterter Oberfläche.
 Das Produktionsprogramm bilden Decken-, Wand- und Pendelleuchten und neulich auch Tischlampen. Im ganzen Sortiment wird eine breite Lichtquellenskala angeboten.
 Die Leuchten können auch mit HF-Sensoren oder Noteinheiten ausgestattet werden.

BESCHREIBUNG DER LEUCHTEN

Аrmatur – Stahlblech mit Pulverlack – IP20, IP41, IP43, IP44
 – Polykarbonatpressteil – IP43 Klasse II, IP65
 – Polypropylenpressteil – IP20, IP53, IP54, Klasse II
 Abdeckung – dreischichtiges mundgeblasenes Glas TRIPLEX OPAL mit matterter Oberfläche Ø 200- 600 mm
 – klares oder opales Polykarbonat oder Polymethylmetakrylat oder Polyethylen
 Aufhängung lackiert) – Stangenaufhängung (Stahlstange Ø 10 mm, Weiß- oder Edelstahl
 – Seilaufhängung (Edelstahlseil mit lackierten oder rostfreien Metallteilen, transparentes Kabel.)
 Halterung der Abdeckscheibe – klappbare doppelverstellbare Halterungen
 – Bajonettverschluss
 – Schraubhalterung
 Lichtquellen – Glühlampen, Leuchtstofflampen, LED Module
 HF-Sensor – Bewegungssensor ist in ausgewählten Leuchtentypen eingebaut.
 Notmodul – in der Leuchte eingebaut, ermöglicht sowohl ausschließlichen Notbetrieb als auch kombinierten Dauerbetrieb.
 Montage – als Wand- oder Deckenleuchte
 Einsatz – Wohnungsbau, Gemeinschaftsräume, Büros, Industrieräume

Verwendete Beschreibungen im Katalog

Tabellenkopf:
 Kode – numerische Bezeichnung für die Bestellung
 Typ – Typenbezeichnung der Leuchte
 W – Leistung, Quellenanzahl (bei Glühlampen maximale genehmigte Leistung)

Fassung – Typ und Anzahl verwendeter Fassungen
 T – minimale Brenndauer der Leuchte im Notbetrieb (in Stunden)

Symbole und Angaben in den Tabellen

A – Glühlampenleuchte (E27, E14)
VVG – Leuchtstofflampe mit magnetischem Vorschaltgerät
EVG – Leuchtstofflampe mit elektronischem Vorschaltgerät
DIM – dimmbare Leuchte: 1-10V – Leuchte mit analog dimmbarem EVG
 DALI – Leuchte mit digital dimmbarem EVG
S Sensorleuchte – geschaltet mit integriertem Hf frequenzsensor (detaillierte Beschreibung auf Seite 206)
N Notleuchte – leuchtet nur im Notbetrieb
NE Kombinierte Notleuchte – mit EVG, leuchtet im Normal- und Notbetrieb
NES Kombinierte Notleuchte – mit EVG und Sensor
LED LED- Leuchten (detaillierte Beschreibung auf Seite 206)

F Introduction

La société Osmond, s.r.o. s'est engagée à produire depuis 1991 des luminaires destinés à un éclairage intérieur et extérieur.
 Elle propose principalement des luminaires avec des abat-jours produits artisanalement en verre opal 3 couches.
 Le programme de production se compose de différents types de lampes fixées au plafond, sur le mur ou de luminaire de suspension et la nouveauté est la création de lampe de chevet.
 Toute la gamme de luminaires est proposée avec différentes variétés de sources de lumière.
 Les luminaires peuvent être de secours ou équipés de capteur à haute fréquence.

Description des luminaires

Monture – tôle en acier traitée avec le vernissage par pulvérisation – IP 20, IP41, IP43, IP44
 – polycarbonate moulé – IP43 classe II, IP 65
 – polypropylene moulé – IP20, IP53, IP54, classe II
 Abat-jour – à trois couches, verre soufflé travaillé manuellement TRIPLEX OPAL avec une surface matée Ø 200-600mm
 – polycarbonate clair ou opal ou le polyméthacrylate de méthyle ou polyéthylène
 Suspension – par tige (tube d'acier d'un diamètre de 10 mm, blanc ou inox)
 – par câble (cable inoxydable avec partie en acier laqué ou inoxydable, câbles transparents)
 Fixation de l'abat-jour – supports basculants à deux positions,
 – fixation par baïonnette
 – fixation par vis
 Sources de lumière – ampoules, les lampes fluorescentes, modules LED
 HF Senseur – luminaire assemblé par un capteur de haute fréquence intégré
 Luminaire de secours – est incorporé dans les luminaires et permet le fonctionnement en mode non seulement de secours mais en mode combiné pour un éclairage en continu
 Montage – sur un plafond ou sur un mur
 Utilisation – constructions locatives, locaux sociaux, bureaux, locaux industriels

Descriptions utilisées dans le catalogue :











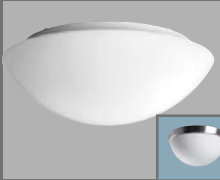
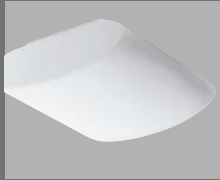



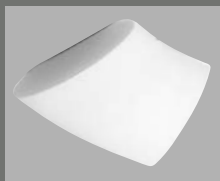
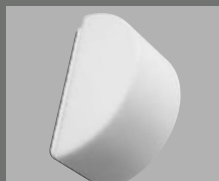









Intitulés des tableaux:
 Code – marquage numérique pour commande
 Type – désignation de type des luminaires
 W – Fonction et nombre de sources, (puissance maximale admis pour les ampoules)
 Culot – Type et nombre de culots
 T – Temps d'éclairage des luminaires en régime de sécurité (en heure)

Symboles et données des tableaux

A – ampoule (E27, E14)
VVG – Lampes fluorescentes à ballast magnétique
EVG – EVG – lampe fluorescente avec ballast électronique
DIM – Luminaire réglable : 1-10V – avec ballast électronique réglable analogique
DALI – luminaire avec ballast électronique réglable numérique
S – CAPTEUR – luminaire avec capteur à haute fréquence (pour une description détaillée page 206)
N – URGENCE – lumière travaillant uniquement en mode urgence
NE – URGENCE COMBINE – luminaire avec ballast électronique qui fonctionne en mode normal et en mode d'urgence
NES – URGENCE COMBINE – EVG – luminaire avec ballast électronique et capteur
LED – éclairage avec sources LED (pour une description détaillée page 206)

I.

PŘISAZENÁ SVÍTIDLA SE STÍNÍTKY ZE SKLA TRIPLEX OPÁL
 SURFACE MOUNTED LAMPS WITH TRIPLEX OPAL GLASS SHADES
 НАКЛАДНЫЕ СВЕТИЛЬНИКИ СО СВЕТОРАСSEИВАТЕЛЯМИ ИЗ
 ТРЕХСЛОЙНОГО ОПАЛОВОГО СТЕКЛА ТРИПЛЕКС ОПАЛ
 WAND- UND DECKENLEUCHTEN MIT ABDECKUNGEN AUS TRIPLEX OPAL GLAS
 LUMINAIRE FIXE AVEC ABAT-JOUR EN VERRE OPALE TRIPLEX

AURA 1,2,3,4,5,9 DL 1,2,3,4,5	8-15				
CRATER 1,2,3,4,5 DL 1,2,3,4,5	16-20				
DRACO 1,2,3,4,5 DL 1,2,3,4,5	21-25				
AURA 6,7,8,10,11 D6,7,8,10,11	26-33				
ELSA 1,2,3,4,5,6 D 1,2,3,4	34-39				
EDNA 1,2,3,4	40-45				
LINA 1,2,3,6,7	46-49				
LINA 4,5	50-51				
SATURN 1,2	52-53				
ALTAIR 1,2	54-55				
GALAXIA	56-57				
SYLVIA 1,2 D 1,2	58-61				
FLORA 1,2,3,4,5	62-65				
JENA 1,2	66-67				
NELA 1,2,3,4A DL 1,2,3	68-73				
LYRA 1,2	74-75				
NEVA 1,2	76-77				
ALMA 1,2 D1,2	78-81				
PYRAMUS 1,2	82-84				
PYRAMUS 3	85				
ORCUS DK	86-87				
STYX 1,2,3,4	88-91				
KIRA 1,2 D1,2	92-95				
MIRA D	96-97				

CZ POPIS SVÍTIDEL:

Svítidla tvoří montura z kovu nebo plastu a skleněné stínítko

Montury	- ocelový plech upravený práškovým lakováním v provedení IP20, IP43, IP44 - polycarbonátový výlisek – IP43, tř. II, IP65
Stínítka	- třívrstvé, ručně vyráběné sklo TRIPLEX OPAL s matovaným povrchem
Dekoratívni doplňky	- kovové límce, které jsou volně podloženy pod stínítkem nebo jsou součástí montury
Držení stínítka	- sklápovacími držáky, bajonetové, šroubkové
Montáž	- na stěnu nebo na strop
Použití	- bytová výstavba (pokojy, koupelny, chodby, schodiště), hotely, školy společenské prostory, venkovní osvětlení

LED

Standardní nabídka - 2 řady LED modulů s různým výkonem a různou dobou záruky:

Svítidla s moduly **L11A07, L12A07, L13A07, L14A07** - 3 roky záruka

Svítidla s moduly **L02A07 a L02A10** - 5 let záruka

*** Nadstandardní nabídka (na zakázku):**

Svítidla **LED-L02A07...TOP a LED-L02A10...TOP** - 7 let záruka

Upozornění: Tyto záruky se vztahují pouze na proudové zdroje a LED moduly

Teploty chromatičnosti LED modulů L11, L12, L13, L14 A07

3000K – teplá bílá, Ra > 80

4000K – neutrální bílá, Ra > 80

Teploty chromatičnosti LED modulů L02A07, L02A10

3000K – teplá bílá, Ra > 80

4000K – neutrální bílá, Ra > 70

EN DESCRIPTION OF THE LIGHTING FITTINGS:

The lighting consist of the metal or plastic fixture and glass shade

Fixtures	- sheet steel polycarbonate modified by the powder painting- IP 20, IP43, and IP44 - polycarbonate moulding – IP 43, class II, IP65
Shades	- three layers, hand blown glass TRIPLEX OPAL with matt surface
Decorative accessories	- metal rings, which are freely placed under the shade or are part of the fixture
Shade attachment	- with folding two-step clamp holders, with bayonet attachment, with screws attachment
Assembly	- to the ceiling or on the wall
Applications	- housing constructions (rooms, bathrooms, corridors, stairs) hotels, schools cultural premises, outdoor

LED

Standard offer – 2 series LED modules with different power and different guarantee time:

Lighting with modules **L11A07, L12A07, L13A07, L14A07** – 3 years guarantee

Lighting with modules **L02A07 a L02A10** – 5 years guarantee

Above – standard offer (for an order):

Lighting **LED-L02A07...TOP and LED-L02A10...TOP** – 7 years guarantee

Notice: These guarantee are concerned only for the current source and LED modules

Chromaticity temperatures of LED modules L11, L12, L13 and L14 A07

3000K – warm white, CRI > 80

4000K – neutral white, CRI > 80

Chromaticity temperatures of LED modules L02A7, L02A10

3000K – warm white, CRI > 80

4000K – neutral white, CRI > 70

RUS ОПИСАНИЕ СВЕТИЛЬНИКОВ:

Светильники состоят из основания (металл или пластик) и стеклянного светорассеивателя

Основание	- лист металла обработанный порошковой краской в исполнении IP20, IP43, IP44 - поликарбонатное основание – IP43, класс II, IP65
Светорассеиватель	- трехслойное, изготовленное вручную опаловое стекло триплекс (TRIPLEX OPAL) с матированной поверхностью
Декоративные элементы	- металлические кольца, которые свободно располагаются под основанием и не являются его частью
Крепление рассеивателя	- откидные фиксаторы - защелки, резьбовое соединение «байонет», винтовое крепление
Установка	- настенный, потолочный
Назначение	- жилые помещения, гостиницы, школы (комнаты, коридоры, лестницы), общественные помещения, наружное освещение

LED

Стандартное исполнение - 2 ряда LED модулей с различной мощностью и разным гарантийным сроком:

- Светильники с модулями **L11A07, L12A07, L13A07, L14A07** – гарантийный срок 3 года

- Светильники с модулями **L02A07 и L02A10** – гарантийный срок 5 лет

* Нестандартное предложение (под заказ):

- Светильники **LED-L02A07...TOP и LED-L02A10...TOP** – гарантийный срок 7 лет

Внимание: Данный гарантийный срок распространяется исключительно на источники тока и LED модули

Индекс цветопередачи LED модулей L11, L12, L13, L14 A07

3000K – теплый белый, Ra > 80

4000K – нейтральный белый, Ra > 80

Индекс цветопередачи LED модулей L02A07, L02A10

3000K – теплый белый, Ra > 80

4000K – нейтральный белый, Ra > 70

DE BESCHREIBUNG DER LEUCHTEN:

Die Leuchten bestehen aus einer Stahlblech- oder Kunststoffarmatur und einer Glasabdeckung

Armatur	- Stahlblech mit Pulverlack - IP20, IP43, IP44 - Polycarbonatpressteil - IP43, IP43 Klasse II, IP65
Abdeckung	- dreischichtiges mundeblasenes Glas TRIPLEX OPAL mit mattierter Oberfläche
Dekoratives Zubehör	- Metallring ist der Abdeckung frei untergesetzt oder gehört zur Armatur
Halterung	- klappbare doppelverstellbare Halterungen
Abdeckscheibe	- Bajonettverschluss, Schraubhalterung
Montage	- als Wand- oder Deckenleuchte
Einsatz	- Wohnungsbau (Zimmer, Badezimmer, Flure, Treppe), Hotels, Schulen Gemeinschaftsräume, Außenbeleuchtung

LED

Standardangebot - 2 Reihen von LED Modulen mit unterschiedlicher Leistung und Garantiezeit

Leuchten mit Modulen **L11A07, L12A07, L13A07, L14A07** - 3 Jahre Garantie

Leuchten mit Modulen **L02A07 und L02A10** - 5 Jahre Garantie

*** Sonderangebot (auf Bestellung):**

Leuchten mit Modulen **LED-L02A07...TOP a LED-L02A10...TOP** - 7 Jahre Garantie

Hinweis: Diese Garantien beziehen sich nur auf Stromquellen und LED Module

Chrominanzfarbe von LED Modulen L11, L12, L13, L14 A07

3000K – Warmweiß, CRI > 80

4000K – Neutralweiß, RCR > 80

Chrominanzfarbe von LED Modulen L02A07, L02A10

3000K – Warmweiß, CRI > 80

4000K – Neutralweiß, CRI > 70

F DESCRIPTION DES LUMINAIRES

Les luminaires se composent d'une monture métallique ou en plastique et d'un abat-jour en verre

Montures	- tôle en acier traitée par le vernissage par pulvérisation – IP 20, IP 43, IP 44 - polycarbonate moulé – IP43, classe II, IP65
Abat-jour	- à trois couches, verre soufflé travaillé artisanalement TRIPLEX OPAL avec une surface mate
Accessoires décoratifs	- col métallique qui est installé en plus sous l'abat-jour ou peut faire aussi partie intégrante de la monture
Fixation de l'abat-jour	- supports clip, fixation par baïonnette, fixation par vis
Montage	- sur un plafond ou sur un mur
Utilisation	- immeubles (chambres, salles de bains, couloirs, halls), hôtels, écoles, locaux publics, extérieurs

LED

Offre standard – 2 séries de module LED avec différentes capacités et garanties :

- Luminaire avec module **L11A07, L12A07, L13A07, L14A07** – garantie 3 ans

- Luminaire avec module **L02A07 a L02A10** – garantie 5 ans

*** Offre haut de gamme (sur commande)**

- Luminaire **LED-L02A07...TOP a LED-L02A10...TOP** – garantie 7 ans

Avertissement: Ces garanties ne s'appliquent que pour la source de courant et les modules LED

La température de couleur des modules LED, L11, L12, L13, L14 A07

3000K – blanc chaud, Ra > 80

4000K – blanc neutre, Ra > 80

La température de couleur des modules LED L02A07, L02A10

3000K – blanc chaud, Ra > 80

4000K – blanc neutre, Ra > 70

AURA 1,2,3,4,5,9

CRATER 1,2,3,4,5

DRACO 1,2,3,4,5



POPIS SVÍTIDEL

Svítidla tvoří montura z kovu nebo plastu a skleněné stínítko

Držení stínítka

- sklápovací držáky

Montáž

- na stěnu nebo na strop

DESCRIPTION OF THE LIGHTING FITTINGS

The lighting fittings consist of the metal or plastic fixture and the glass shade

Shade attachment

- with folding two-step clamp holders

Assembly

- to the ceiling or on the wall

ОПИСАНИЕ СВЕТИЛЬНИКОВ

Светильники состоят из основания (металл или пластик) и стеклянного светорассеивателя

Крепление рассеивателя

- фиксаторы - защелки

Установка

- на стену, на потолок

BESCHREIBUNG DER LEUCHTEN

Die Leuchten bestehen aus einer Stahlblech- oder Kunststoffarmatur und einer Glasabdeckung.

Halterung der Abdeckscheibe

- klappbare Halterungen

Montage

- als Wand- oder Deckenleuchten

DESCRIPTION DES LUMINAIRES

Les luminaires se composent d'une monture métallique ou en plastique et d'un abat-jour en verre

Fixation de l'abat-jour

- supports clip à deux positions

Montage

- sur un plafond ou sur un mur



AURA

CRATER

DRACO

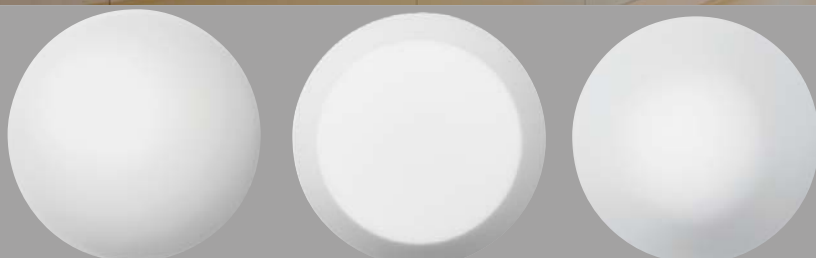



POPIS SVÍTIDEL S DEKORATIVNÍMI LÍMCI

Svítidla tvoří montura z kovu, skleněné stínítko a dekorativní kovový límeček

Dekorativní límeček - volně podložený pod stínítkem

Upozornění: veškerá svítidla s dekorativními límci lze vybavit i LED zdroji – viz AURA 1-5

DESCRIPTION OF THE LIGHTING FITTINGS WITH DECORATIVE RINGS

The lighting fittings consist of the metal fixture, the glass shade and the decorative metal ring

Decorative ring - is freely placed under the shade

Notice: it is possible to equip all the light fittings with decorative rings with LED sources too - SEE AURA 1-5

ОПИСАНИЕ СВЕТИЛЬНИКОВ

Светильники состоят из металлического основания, стеклянного светорассеивателя и декоративного металлического кольца

Декоративное кольцо - установлено свободно под светорассеивателем

Внимание: все светильники с декоративными кольцами могут быть изготовлены со светодиодами – см. AURA 1-5

BESCHREIBUNG DER LEUCHTEN MIT DEKORATIVEM METALLRING

Die Leuchten bestehen aus einer Stahlblecharmatur, einer Glasabdeckung und einem dekorativen Metallring

Der dekorative Metallring - ist der Abdeckscheibe frei untergesetzt

Hinweis: Sämtliche Leuchten mit dekorativen Ringen können auch mit einer LED-Lampen ausgestattet werden - siehe Aura 1-5

DESCRIPTION DES LUMINAIRES AVEC COL DECORATIF

Tous les luminaires d'intérieur se composent d'une monture métallique, d'un abat-jour en verre et un col decorative

Col décoratif - est calé discrètement sous l'abat-jour

Tous les luminaires avec col decorative peuvent également être équipés de LED - voir AURA 1-5



Dekorativní límeček / Decorative ring / Декоративное кольцо / Dekorativer Ring / col décoratif

DL4 bílý lak / White paint / белый лак / Weißlack / Laqué blanc

DL14 nerez leštěná / stainless steel polished / хром / Edelstahl poliert / Inox poli

DL15 nerez broušená / stainless steel ground / матовый хром / Edelstahl geschliffen / Inox émoulu



AURA DL 1,2,3,4,5
CRATER DL 1,2,3,4,5
DRACO DL 1,2,3,4,5



AURA 1



Ø 220 mm

Náhradní stínítko/spare shade/запасное стекло

Kód/code/код	Typ/Type/тип	Ø [mm]
20001	040	220

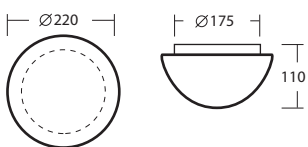

Ø 240 mm

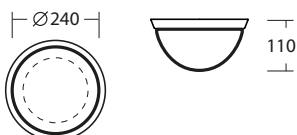

AURA 1 IP43

Kód code код	typ type тип	Zdroj source лампа	příkon input [W]	objímka socket патрон	T [h]
A					
40000	IN-12K2/040		60	E27	
VVG					
40003	IN-14K2/040		13	G24d1	
EVG					
40004	E-14K2/040		13	G24q1	
N					
40014	NZ-7/040		7	2G7	1,0
A					
40010	IN-12DU2/040		60	E27	
EVG					
40013	E-13DU2/040		9	2G7	
N					
40016	NZ-7/DU/040		7	2G7	1,0

LED IP43

Kód code код	kód code код	typ type тип	[lm] 3000K	[lm] 4000K	příkon input [W]	T [h]	záruka Guarantee [years]
47415	47915	LED-1L11A07K2/040.000	740	740	9		3
47416	47916	LED-2L02A07K2/040.000	920	990	11		5
N							
-	47075	LED-NZ1W/040.4000	-	100	1	1,0	3

AURA DL1 IP41

kód/DL4 code/DL4 код/DL4	kód/DL14 code/DL14 код/DL14	kód/DL15 code/DL15 код/DL15	typ type тип	příkon input [W]	objímka socket патрон	T [h]
A						
43100	43112	43124	IN-12K2/040/DL..	60	E27	
EVG						
43102	43114	43126	E-14K2/040/DL..	13	G24q1	
N						
43103	43115	43127	NZ-7/040/DL..	7	2G7	1,0

AURA 2 IP43

Kód code код	typ type тип	Zdroj source лампа	přikon input [W]	objímka socket патрон	T [h]
A					
40017	IN-12K52/042		100	E27	
40018	IN-22K52/042		2x60	2xE27	
VVG					
40022	IN-15K52/042		18	G24d2	
40023	IN-16K52/042		26	G24d3	
40024	IN-24K52/042		2x13	2xG24d1	
EVG					
40027	E-15K52/042		18	G24q2	
40028	E-16K52/042		26	G24q3	
40029	E-24K52/042		2x13	2xG24q1	
S					
46100	IN-12K52/042 HF		60	E27	
46138	E-16K52/042 HF		26	G24q3	
N					
40049	NZ-13/042		13	G24q1	1,0
NE					
40052	NK-E-13/042		13	G24q1	1,0
46364	NK-E-18/042		18	G24q2	1,0
A					
40042	IN-12DU52/042		100	E27	
E					
40046	E-14DU52/042		13	G24q1	
N					
40051	NZ-13/DU/042		13	G24q1	1,0

LED IP43

Kód code код	kód code код	typ type тип	[lm] 3000K	[lm] 4000K	přikon input [W]	T [h]	záruka Guarantee [years]
47417	47917	LED-1L12A07K53/042.000	980	980	11		3
47418	47918	LED-3L02A07K53/042.000	1380	1470	15		5*
47419	47919	LED-3L02A10K53/042.000	1850	1970	23		5*
DIM							
47420	47920	LED-3L02A10K53/042 1-10V.000	1850	1970	23		5
47421	47921	LED-3L02A10K53/042 DALI.000	1850	1970	23		5
S							
47422	47922	LED-1L12A07K53/042 HF.000	980	980	11		3
47423	47923	LED-3L02A10K53/042 HF.000	1850	1970	23		5
NE							
47424	47924	LED-1L12A07K53/042/NK1W.000	980	980	11	3,0	3
47425	47925	LED-3L02A07K53/042/NK1W.000	1380	1470	15	3,0	5

AURA DL2 IP41

kód/DL4 code/DL4 код/DL4	kód/DL14 code/DL14 код/DL14	kód/DL15 code/DL15 код/DL15	typ type тип	přikon input [W]	objímka socket патрон	T [h]
A						
43136	43165	43194	IN-12K52/042/DL..	100	E27	
43137	43166	43195	IN-22K52/042/DL..	2x60	2xE27	
EVG						
43141	43170	43199	E-15K52/042/DL..	18	G24q2	
43142	43171	43200	E-16K52/042/DL..	26	G24q3	
43143	43172	43201	E-24K52/042/DL..	2x13	2xG24q1	
S						
43144	43173	43202	IN-12K52/042/DL.. HF	60	E27	
43146	43175	43204	E-16K52/042/DL.. HF	26	G24q3	
N						
43147	43176	43205	NZ-13/042/DL..	13	G24q1	1,0
NE						
55301	55302	55303	NK-E-18/042/DL..	18	G24q2	1,0



Náhradní stínítko/spare shade/запасное стекло

Kód/code/код	Typ/Type/тип	D [mm]
20002	042	280

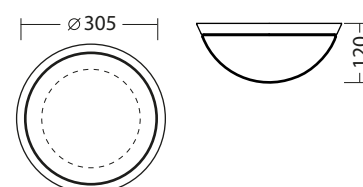
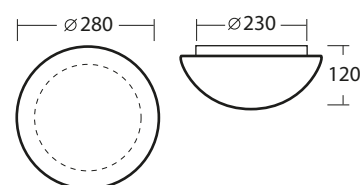

AURA 3



Ø 350 mm

Náhradní stínítko/spare shade/запасное стекло

Kód/code/код	Typ/Type/тип	D [mm]
20003	062	350

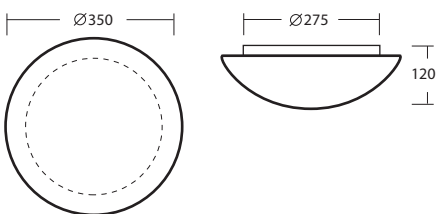

Ø 385 mm

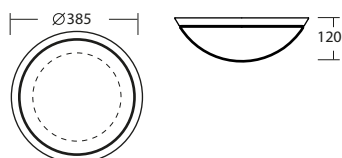

AURA 3 IP43

Kód code код	typ type тип	Zdroj source лампа	příkon input [W]	objímka socket патрон	T [h]
A					
42630	IN-12K63/062		100	E27	
40055	IN-22K63/062		2x75	2xE27	
VVG					
42306	IN-16K63/062		26	G24d3	
40057	IN-25K63/062		2x18	2xG24d2	
EVG					
42307	E-16K63/062		26	G24q3	
40059	E-25K63/062		2x18	2xG24q2	
DIM					
42634	ES-25K63/062 1-10V		2x18	2xG24q2	
44018	ES-25K63/062 DALI		2x18	2xG24q2	
S					
46102	IN-12K63/062 HF		75	E27	
46141	E-16K63/062 HF		26	G24q3	
N					
40071	NZ-18/062		18	G24q2	1,0
NE					
40081	NK-E-26/062		26	G24q3	1,0
NES					
44028	NK-E-26/062 HF		26	G24q3	1,0
A					
40066	IN-22DU63/062		2x60	2xE27	
EVG					
40069	E-16DU63/062		26	G24q3	
NE					
40084	NK-E-13/DU/062		13	G24q1	1,0

LED IP43

Kód code код	kód code код	typ type тип	[lm]	[lm]	příkon input [W]	T [h]	záruka Guarantee [years]
3000K	4000K		3000K	4000K			
47426	47926	LED-1L13A07K64/062.000	1480	1480	16		3
47427	47927	LED-4L02A07K64/062.000	1840	1970	20		5*
47428	47928	LED-4L02A10K64/062.000	2460	2630	30		5*
DIM							
47429	47929	LED-4L02A10K64/062 1-10V.000	2460	2630	30		5
47430	47930	LED-4L02A10K64/062 DALI.000	2460	2630	30		5
S							
47431	47931	LED-1L13A07K64/062 HF.000	1480	1480	16		3
47432	47932	LED-4L02A10K64/062 HF.000	2460	2630	30		5*
NE							
47433	47933	LED-1L13A07K64/062/NK1W.000	1480	1480	16	3,0	3
47434	47934	LED-4L02A10K64/062/NK1W.000	2460	2630	30	3,0	5*
NES							
47435	47935	LED-1L13A07K64/062/NK1W HF.000	1480	1480	16	3,0	3
47436	47936	LED-4L02A10K64/062/NK1W HF.000	2460	2630	30	3,0	5*

AURA DL3 IP41

kód/DL4 code/DL4 код/DL4	kód/DL14 code/DL14 код/DL14	kód/DL15 code/DL15 код/DL15	typ type тип	příkon input [W]	objímka socket патрон	T [h]
A						
43223	43258	43293	IN-12K63/062/DL..	100	E27	
43224	43259	43294	IN-22K63/062/DL..	2x75	2xE27	
EVG						
43227	43262	43297	E-16K63/062/DL..	26	G24q3	
43228	43263	43298	E-25K63/062/DL..	2x18	2xG24q2	
DIM						
43229	43264	43299	ES-25K63/062/DL.. 1-10V	2x18	2xG24q2	
43231	43266	43301	ES-25K63/062/DL.. DALI	2x18	2xG24q2	
S						
43232	43267	43302	IN-12K63/062/DL.. HF	75	E27	
43233	43268	43303	E-16K63/062/DL.. HF	26	G24q3	
N						
43234	43269	43304	NZ-18/062/DL..	18	G24q2	1,0
NE						
43238	43273	43308	NK-E-26/062/DL..	26	G24q3	1,0
NES						
55304	55305	55306	NK-E-26/062/DL.. HF	26	G24q3	1,0

AURA 4 IP43					
Kód code код	typ type тип	Zdroj source лампа	přikon input [W]	objímka socket патрон	T [h]
A					
40086	IN-22K74/072		2x75	2x E27	
VVG					
42304	IN-17K74/072		36	2G10	
40087	IN-26K74/072		2x26	2xG24d3	
EVG					
42305	E-17K74/072		36	2G10	
40088	E-26K74/072		2x26	2xG24q3	
42308	E-26K74/072 32W		2x32	2xGX24q3	
DIM					
42419	ES-26K74/072 1-10V		2x26	2xG24q3	
44015	ES-26K74/072 DALI		2x26	2xG24q3	
S					
46104	IN-22K74/072 HF		2x60	2xE27	
46143	E-17K74/072 HF		36	2G10	
NE					
40093	NK-E-36/072		36	2G10	1,0
46202	NKC-226/13/072		2x26	2xG24q3	1,0

LED IP43							
Kód code код	kód code код	typ type тип	[lm]	[lm]	přikon input [W]	T [h]	záruka Guarantee [years]
			3000K	4000K			
47437	47937	LED-1L14A07K75/072.000	1970	1970	21		3
47438	47938	LED-5L02A10K75/072.000	3080	3280	37		5*
DIM							
47439	47939	LED-5L02A10K75/072 1-10V.000	3080	3280	37		5
47440	47940	LED-5L02A10K75/072 DALI.000	3080	3280	37		5
S							
47441	47941	LED-1L14A07K75/072 HF.000	1970	1970	21		3
47442	47942	LED-5L02A10K75/072 HF.000	3080	3280	37		5*
NE							
47443	47943	LED-1L14A07K75/072/NK1W.000	1970	1970	21	3,0	3
47444	47944	LED-5L02A10K75/072/NK1W.000	3080	3280	37	3,0	5*

AURA DL4 IP41							
kód/DL4 code/DL4 код/DL4	kód/DL14 code/DL14 код/DL14	kód/DL15 code/DL15 код/DL15	typ type тип	přikon input [W]	objímka socket патрон	T [h]	
A							
43328	43345	43362	IN-22K74/072/DL..	2x75	2x E27		
EVG							
43331	43348	43365	E-17K74/072/DL..	36	2G10		
43332	43349	43366	E-26K74/072/DL..	2x26	2xG24q3		
43333	43350	43367	E-26K74/072/DL.. 32W	2x32	2xGX24q3		
DIM							
43334	43351	43368	ES-26K74/072/DL.. 1-10V	2x26	2xG24q3		
43336	43353	43370	ES-26K74/072/DL.. DALI	2x26	2xG24q3		
S							
43337	43354	43371	IN-22K74/072/DL.. HF	2x75	2x E27		
43338	43355	43372	E-17K74/072/DL.. HF	36	2G10		
NE							
43343	43360	43377	NK-E-36/072/DL..	36	2G10	1,0	
43344	43361	43378	NKC-226/13/072/DL..	2x26	2xG24q3	1,0	



Náhradní stínítko/spare shade/запасное стекло

Kód/code/код	Typ/Type/тип	D [mm]
20004	072	420

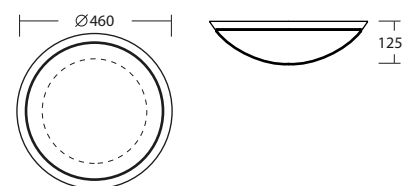
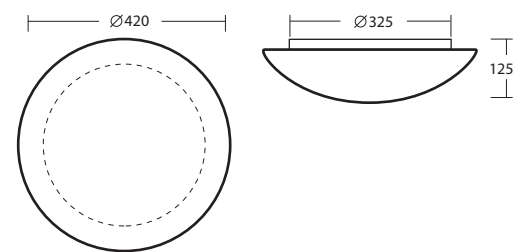

AURA 5

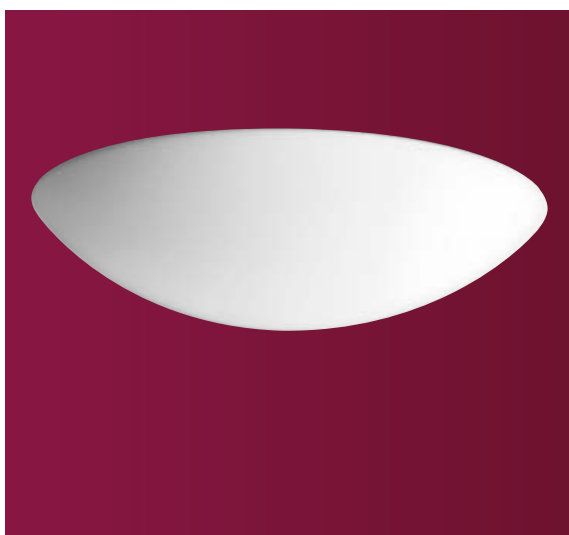

Ø 490 mm

Náhradní stínítko/spare shade/запасное стекло

Kód/code/код	Typ/Type/тип	D [mm]
20005	082	490

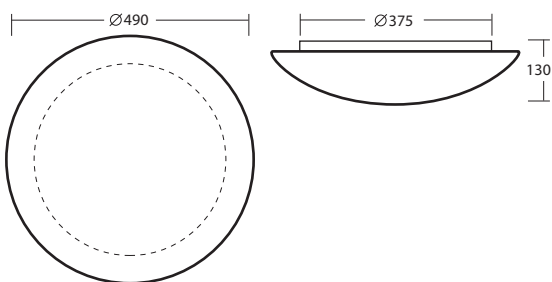

Ø 535 mm

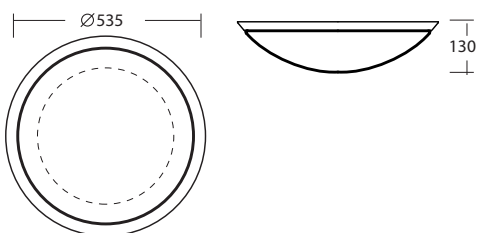

AURA 5 IP43

Kód code код	typ type тип	Zdroj source лампа	příkon input [W]	objemka socket патрон	T [h]
A					
40095	IN-32K86/082		3x60	3x E27	
VVG					
40096	IN-27K86/082		2x36	2x2G10	
EVG					
42554	E-204K86/082		22+40	2x2GX13	
40097	E-27K86/082		2x36	2x2G10	
42309	E-28K86/082		2x42	2xGX24q4	
DIM					
44029	ES-26K86/082 32W 1-10V		2x32	2xGX24q3	
44030	ES-26K86/082 32W DALI		2x32	2xGX24q3	
44031	ES-28K86/082 1-10V		2x42	2xGX24q4	
44032	ES-28K86/082 DALI		2x42	2xGX24q4	
S					
46105	IN-22K86/082 HF		2x60	2x E27	
46144	E-17K86/082 HF		36	2G10	
NE					
40103	NK-E-36/082		36	2G10	1,0
46203	NKC-226/13/082		2x26	2xG24q3	1,0
46283	NKC-232/16/082		2x32	2xGX24q3	1,0

LED IP43

Kód code код	kód code код	typ type тип	[lm] 3000K	[lm] 4000K	příkon input [W]	T [h]	záruka Guarantee [years]
47445	47945	LED-4L11A07K86/082 .000	2950	2950	30		3
47446	47946	LED-6L02A10K86/082 .000	3700	3940	43		5*
DIM							
47447	47947	LED-6L02A10K86/082 1-10V .000	3700	3940	43		5
47448	47948	LED-6L02A10K86/082 DALI .000	3700	3940	43		5
S							
47449	47949	LED-4L11A07K86/082 HF .000	2950	2950	30		3
47450	47950	LED-6L02A10K86/082 HF .000	3700	3940	43		5*
NE							
47451	47951	LED-4L11A07K86/082/NK1W .000	2950	2950	30	3,0	3
47452	47952	LED-6L02A10K86/082/NK1W .000	3700	3940	43	3,0	5*

AURA DL5 IP41

kód/DL4 code/DL4 код/DL4	kód/DL14 code/DL14 код/DL14	kód/DL15 code/DL15 код/DL15	typ type тип	příkon input [W]	objemka socket патрон	T [h]
A						
43379	43395	43411	IN-32K86/082/DL..	3x60	3x E27	
EVG						
43381	43397	43413	E-204K86/082/DL..	22+40	2x2GX13	
43382	43398	43414	E-27K86/082/DL..	2x36	2x2G10	
43383	43399	43415	E-28K86/082/DL..	2x42	2xG24q4	
DIM						
43976	43981	43986	ES-26K86/082/DL.. 32W 1-10V	2x32	2xGX24q3	
43977	43982	43987	ES-26K86/082/DL.. 32W DALI	2x32	2xGX24q3	
43978	43983	43988	ES-28K86/082/DL.. 1-10V	2x42	2xGX24q4	
43979	43984	43989	ES-28K86/082/DL.. DALI	2x42	2xGX24q4	
S						
43387	43403	43419	IN-22K86/082/DL.. HF	2x60	2x E27	
43388	43404	43420	E-17K86/082/DL.. HF	36	2G10	
NE						
43393	43409	43425	NK-E-36/082/DL..	36	2G10	1,0
43394	43410	43426	NKC-226/13/082/DL..	2x26	2xG24q3	1,0
43980	43985	43990	NKC-232/16/082/DL..	2x32	2xGX24q3	1,0



AURA 9 IP43

Kód code код	typ type тип	Zdroj source лампа	přikon input [W]	objímka socket патрон	T [h]
--------------------	--------------------	--------------------------	------------------------	-----------------------------	----------





A

42400	IN-32K98/084		3x75	3xE27	
-------	--------------	---	------	-------	--



VVG

42401	IN-27K98/084		2x36	2xG10	
42402	IN-46K98/084		4x26	4xG24d3	



EVG

42403	E-27K98/084		2x36	2xG10	
44033	E-28K98/084		2x42	2xGX24q4	
42404	E-46K98/084		4x26	4xG24q3	
42409	E-46K98/084 32W		4x32	4xGX24q3	

DIM

42555	ES-46K98/084 1-10V		4x26	4xG24q3	
42556	ES-46K98/084 DALI		4x26	4xG24q3	

S

46106	IN-32K98/084 HF		3x60	3xE27	
46145	E-17K968/084 HF		36	2G10	

NE

46204	NKC-232/16/084		2x32	2xGX24q3	1,0
46205	NKC-242/16/084		2x42	2xGX24q4	1,0

LED IP43

Kód code код	kód code код	typ type тип	[lm] 3000K	[lm] 4000K	přikon input [W]	T [h]	záruka Guarantee [years]
47453	47953	LED-4L12A07K98/084 .000	3940	3940	41		3
47454	47954	LED-8L02A10K98/084 .000	4930	5250	58		5*

DIM

47455	47955	LED-8L02A10K98/084 1-10V .000	4930	5250	58		5
47456	47956	LED-8L02A10K98/084 DALI .000	4930	5250	58		5

S

47457	47957	LED-4L12A07K98/084 HF .000	3940	3940	41		3
47458	47958	LED-8L02A10K98/084 HF .000	4930	5250	58		5*

NE

47459	47959	LED-4L12A07K98/084/NK1W .000	3940	3940	41	3,0	3
47460	47960	LED-8L02A10K98/084/NK1W .000	4930	5250	58	3,0	5*

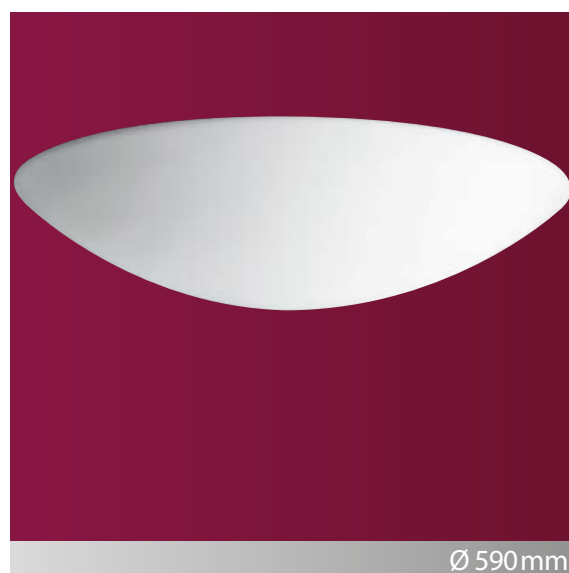

Ø 590 mm

Náhradní stínítko/spare shade/запасное стекло

Kód/code/код	Typ/Type/тип	D [mm]
20050	084	590

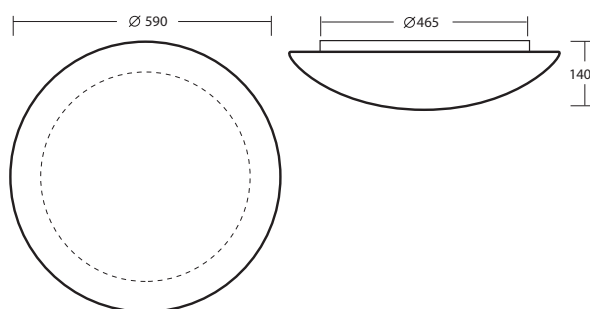

CRATER 1



Ø 220 mm

Náhradní stínítko/spare shade/запасное стекло

Kód/code/код	Typ/Type/тип	D [mm]
20057	051	220

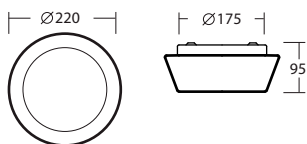

Ø 240 mm

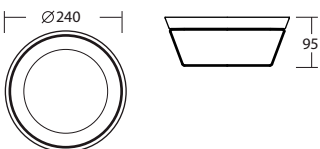

CRATER 1 IP43

Kód code код	typ type тип	Zdroj source лампа	příkon input [W]	objímka socket патрон	T [h]
A					
42800	IN-12K2/051		60	E27	
VVG					
42801	IN-14K2/051		13	G24d1	
EVG					
42802	E-14K2/051		13	G24q1	
N					
42803	NZ-7/051		7	2G7	1,0
A					
42808	IN-12DU2/051		60	E27	
EVG					
42810	E-13DU2/051		9	2G7	
N					
42811	NZ-7/DU/051		7	2G7	1,0

LED IP43

Kód code код	kód code код	typ type тип	[lm] 3000K	[lm] 4000K	příkon input [W]	T [h]	záruka Guarantee [years]
3000K	4000K						
48406	48906	LED-1L11A07K2/051.000	740	740	9		3
48407	48907	LED-2L02A07K2/051.000	920	990	11		5
N							
-	47120	LED-NZ1W/051.4000		100	1	1,0	3

CRATER DL1 IP41

kód/DL4 code/DL4 код/DL4	kód/DL14 code/DL14 код/DL14	kód/DL15 code/DL15 код/DL15	typ type тип	příkon input [W]	objímka socket патрон	T [h]
A						
43430	43442	43454	IN-12K2/051/DL..	60	E27	
EVG						
43432	43444	43456	E-14K2/051/DL..	13	G24q1	
N						
43433	43445	43457	NZ-7/051/DL..	7	2G7	1,0

CRATER 2 IP43

Kód code код	typ type тип	Zdroj source лампа	přikon input [W]	objímka socket патрон	T [h]
A					
42812	IN-12K53/052		100	E27	
42813	IN-22K53/052		2x60	2xE27	
VVG					
42814	IN-15K53/052		18	G24d2	
42815	IN-16K53/052		26	G24d3	
42816	IN-24K53/052		2x13	2xG24d1	
EVG					
42818	E-15K53/052		18	G24q2	
42819	E-16K53/052		26	G24q3	
42820	E-24K53/052		2x13	2xG24q1	
S					
42821	IN-12K53/052 HF		60	E27	
42823	E-16K53/052 HF		26	G24q3	
N					
42824	NZ-13/052		13	G24q1	1,0
NE					
42825	NK-E-13/052		13	G24q1	1,0
44114	NK-E-18/052		18	G24q2	1,0
A					
42839	IN-12DU53/052		100	E27	
EVG					
42841	E-14DU53/052		13	G24q1	
N					
42842	NZ-13/DU/052		13	G24q1	1,0

LED IP43

Kód code код	kód code код	typ type тип	[lm]		přikon input [W]	T [h]	záruka Guarantee [years]
			3000K	4000K			
48408	48908	LED-1L12A07K53/052.000	980	980	11		3
48409	48909	LED-3L02A07K53/052.000	1380	1470	15		5*
48410	48910	LED-3L02A10K53/052.000	1850	1970	23		5*
DIM							
48411	48911	LED-3L02A10K53/052 1-10V.000	1850	1970	23		5
48412	48912	LED-3L02A10K53/052 DALI.000	1850	1970	23		5
S							
48413	48913	LED-1L12A07K53/052 HF.000	980	980	11		3
48414	48914	LED-3L02A10K53/052 HF.000	1850	1970	23		5
NE							
48415	48915	LED-1L12A07K53/052/NK1W.000	980	980	11	3,0	3
48416	48916	LED-3L02A07K53/052/NK1W.000	1380	1470	15	3,0	5

CRATER DL2 IP41

kód/DL4 code/DL4 код/DL4	kód/DL14 code/DL14 код/DL14	kód/DL15 code/DL15 код/DL15	typ type тип	přikon input [W]	objímka socket патрон	T [h]
A						
43466	43495	43524	IN-12K53/052/DL..	100	E27	
43467	43496	43525	IN-22K53/052/DL..	2x60	2xE27	
EVG						
43471	43500	43529	E-15K53/052/DL..	18	G24q2	
43472	43501	43530	E-16K53/052/DL..	26	G24q3	
43473	43502	43531	E-24K53/052/DL..	2x13	2xG24q1	
S						
43474	43503	43532	IN-12K53/052/DL.. HF	60	E27	
43476	43505	43534	E-16K53/052/DL.. HF	26	G24q3	
N						
43477	43506	43535	NZ-13/052/DL..	13	G24q1	1,0
NE						
44115	44116	44117	NK-E-18/052/DL..	18	G24q2	1,0



Ø 280 mm

Náhradní stínítko/spare shade/запасное стекло

Kód/code/код	Typ/Type/тип	D [mm]
20058	052	280

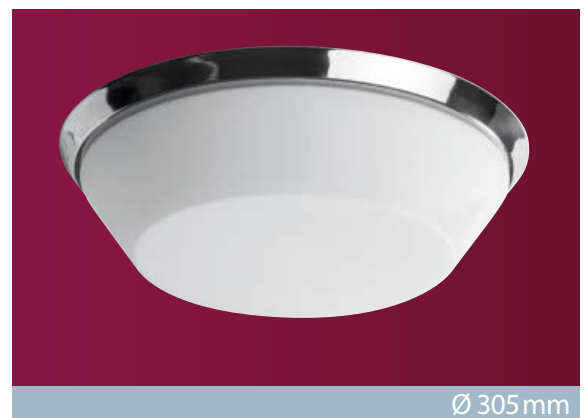
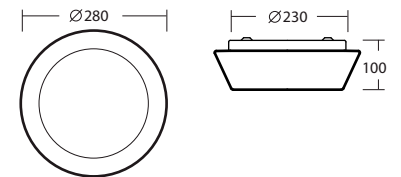

Ø 305 mm

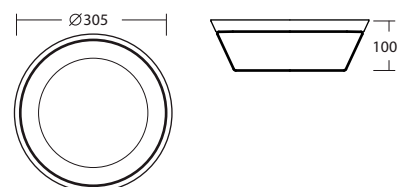

CRATER 3



Ø 350 mm

Náhradní stínítko/spare shade/запасное стекло

Kód/code/код	Typ/Type/тип	D [mm]
20059	053	350

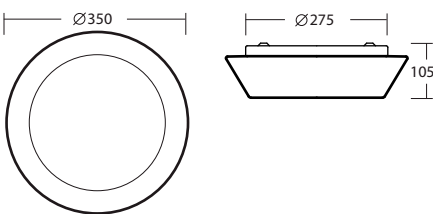

CRATER 3 IP43

Kód code код	typ type тип	Zdroj source лампа	příkon input [W]	objímka socket патрон	T [h]
A					
42844	IN-12K64/053		100	E27	
42845	IN-22K64/053		2x75	2xE27	
VVG					
42846	IN-16K64/053		26	G24d3	
42847	IN-25K64/053		2x18	2xG24d2	
EVG					
42848	E-16K64/053		26	G24q3	
42849	E-25K64/053		2x18	2xG24q2	
DIM					
42850	ES-25K64/053 1-10V		2x18	2xG24q2	
42852	ES-25K64/053 DALI		2x18	2xG24q2	
S					
42853	IN-12K64/053 HF		75	E27	
42854	E-16K64/053 HF		26	G24q3	
N					
42855	NZ-18/053		18	G24q2	1,0
NE					
42858	NK-E-18/053		18	G24q2	1,0
42859	NK-E-26/053		26	G24q3	1,0
NES					
44118	NK-E-26/053 HF		26	G24q3	1,0
A					
42875	IN-22DU64/053		2x60	2xE27	
EVG					
42877	E-16DU64/053		26	G24q3	
NE					
42879	NK-E-13/DU/053		13	G24q1	1,0

LED IP43

Kód code код	kód code код	typ type тип	[lm] 3000K	[lm] 4000K	příkon input [W]	T [h]	záruka Guarantee [years]
48417	48917	LED-1L13A07K64/053.000	1480	1480	16		3
48418	48918	LED-4L02A07K64/053.000	1840	1970	20		5*
48419	48919	LED-4L02A10K64/053.000	2460	2630	30		5*
DIM							
48420	48920	LED-4L02A10K64/053 1-10V.000	2460	2630	30		5
48421	48921	LED-4L02A10K64/053 DALI.000	2460	2630	30		5
S							
48422	48922	LED-1L13A07K64/053 HF.000	1480	1480	16		3
48423	48923	LED-4L02A10K64/053 HF.000	2460	2630	30		5*
NE							
48424	48924	LED-1L13A07K64/053/NK1W.000	1480	1480	16	3,0	3
48425	48925	LED-4L02A10K64/053/NK1W.000	2460	2630	30	3,0	5*
NES							
48426	48926	LED-1L13A07K64/053/NK1W HF.000	1480	1480	16	3,0	3
48427	48927	LED-4L02A10K64/053/NK1W HF.000	2460	2630	30	3,0	5*

CRATER DL3 IP41

kód/DL4 code/DL4 код/DL4	kód/DL14 code/DL14 код/DL14	kód/DL15 code/DL15 код/DL15	typ type тип	příkon input [W]	objímka socket патрон	T [h]
A						
43553	43588	43623	IN-12K64/053/DL..	100	E27	
43554	43589	43624	IN-22K64/053/DL..	2x75	2xE27	
EVG						
43557	43592	43627	E-16K64/053/DL..	26	G24q3	
43558	43593	43628	E-25K64/053/DL..	2x18	2xG24q2	
DIM						
43559	43594	43629	ES-25K64/053/DL.. 1-10V	2x18	2xG24q2	
43561	43596	43631	ES-25K64/053/DL.. DALI	2x18	2xG24q2	
S						
43562	43597	43632	IN-12K64/053/DL.. HF	75	E27	
43563	43598	43633	E-16K64/053/DL.. HF	26	G24q3	
N						
43564	43599	43634	NZ-18/053/DL..	18	G24q2	1,0
NE						
43568	43603	43638	NK-E-26/053/DL..	26	G24q3	1,0
NES						
44119	44120	44121	NK-E-26/053/DL.. HF	26	G24q3	1,0



Ø 385 mm

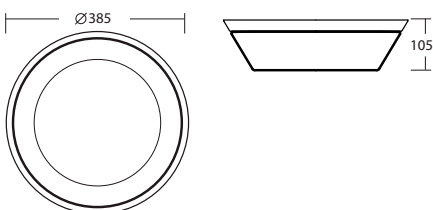

CRATER 4 IP43					
Kód code код	typ type тип	Zdroj source лампа	přikon input [W]	objímka socket патрон	T [h]
A					
42880	IN-22K74/054		2x75	2x E27	
VVG					
42881	IN-17K74/054		36	2G10	
42882	IN-26K74/054		2x26	2xG24d3	
EVG					
42883	E-17K74/054		36	2G10	
42884	E-26K74/054		2x26	2xG24q3	
42885	E-26K74/054 32W		2x32	2xGX24q3	
DIM					
42886	ES-26K74/054 1-10V		2x26	2xG24q3	
42888	ES-26K74/054 DALI		2x26	2xG24q3	
S					
42889	IN-22K74/054 HF		2x60	2xE27	
42890	E-17K74/054 HF		36	2G10	
NE					
42895	NK-E-36/054		36	2G10	1,0
42896	NKC-226/13/054		2x26	2xG24q3	1,0

LED IP43							
Kód code код	kód code код	typ type тип	[lm]	[lm]	přikon input [W]	T [h]	záruka Guarantee [years]
	3000K	4000K	3000K	4000K			
48428	48928	LED-1L14A07K75/054.000	1970	1970	21		3
48429	48929	LED-5L02A10K75/054.000	3080	3280	37		5*
DIM							
48430	48930	LED-5L02A10K75/054 1-10V.000	3080	3280	37		5
48431	48931	LED-5L02A10K75/054 DALI.000	3080	3280	37		5
S							
48432	48932	LED-1L14A07K75/054 HF.000	1970	1970	21		3
48433	48933	LED-5L02A10K75/054 HF.000	3080	3280	37		5*
NE							
48434	48934	LED-1L14A07K75/054/NK1W.000	1970	1970	21	3,0	3
48435	48935	LED-5L02A10K75/054/NK1W.000	3080	3280	37	3,0	5*

CRATER DL4 IP41							
kód/DL4 code/DL4 код/DL4	kód/DL14 code/DL14 код/DL14	kód/DL15 code/DL15 код/DL15	typ type тип	přikon input [W]	objímka socket патрон	T [h]	
A							
43658	43675	43692	IN-22K74/054/DL..	2x75	2x E27		
EVG							
43661	43678	43695	E-17K74/054/DL..	36	2G10		
43662	43679	43696	E-26K74/054/DL..	2x26	2xG24q3		
43663	43680	43697	E-26K75/054/DL.. 32W	2x32	2xGX24q3		
DIM							
43664	43681	43698	ES-26K74/054/DL.. 1-10V	2x26	2xG24q3		
43666	43683	43700	ES-26K74/054/DL.. DALI	2x26	2xG24q3		
S							
43667	43684	43701	IN-22K74/054/DL.. HF	2x75	2xE27		
43668	43685	43702	E-17K74/054/DL.. HF	36	2G10		
NE							
43673	43690	43707	NK-E-36/054/DL..	36	2G10	1,0	
43674	43691	43708	NKC-226/13/054/DL..	2x26	2xG24q3	1,0	



Ø 420 mm

Náhradní stínítko/spare shade/запасное стекло

Kód/code/код	Typ/Type/тип	D [mm]
20060	054	420

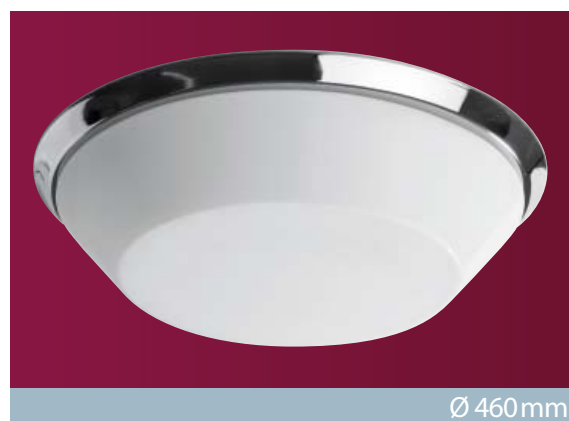
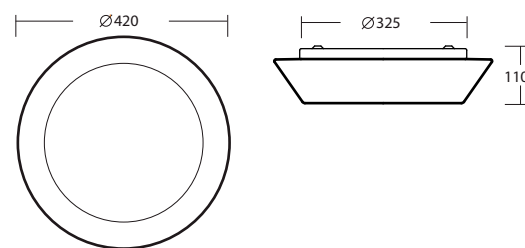

Ø 460 mm

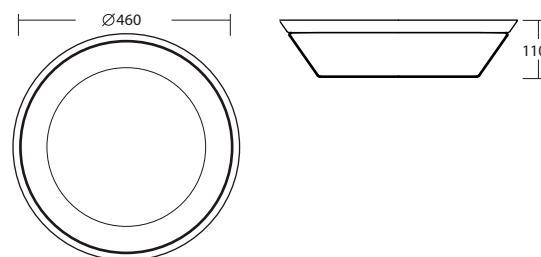

CRATER 5



Ø 490 mm

Náhradní stínítko/spare shade/запасное стекло

Kód/code/код	Typ/Type/тип	D [mm]
20061	055	490

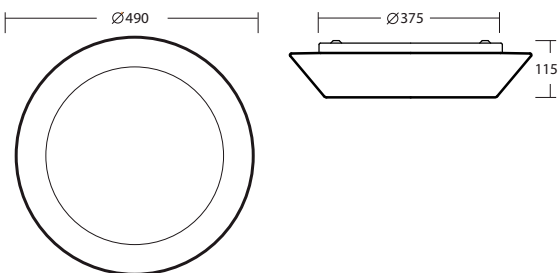

Ø 535 mm

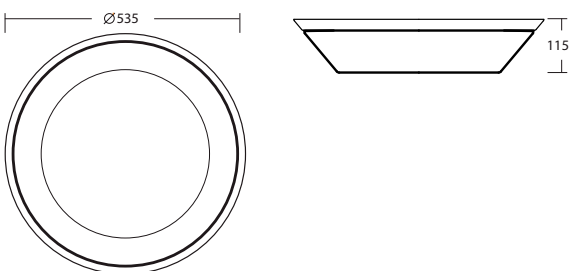

CRATER 5 IP43

Kód code код	typ type тип	Zdroj source лампа	příkon input [W]	objímka socket патрон	T [h]
A					
42897	IN-32K86/055		3x60	3x E27	
VVG					
42898	IN-27K86/055		2x36	2x2G10	
EVG					
42899	E-204K86/055		22+40	2x2GX13	
42900	E-27K86/055		2x36	2x2G10	
42901	E-28K86/055		2x42	2xGX24q4	
DIM					
44122	ES-26K86/055 32W 1-10V		2x32	2xGX24q3	
44123	ES-26K86/055 32W DALI		2x32	2xGX24q3	
44124	ES-28K86/055 1-10V		2x42	2xGX24q4	
44125	ES-28K86/055 DALI		2x42	2xGX24q4	
S					
42905	IN-22K86/055 HF		2x60	2x E27	
42906	E-17K86/055 HF		36	2G10	
NE					
42911	NK-E-36/055		36	2G10	1,0
42912	NKC-226/13/055		2x26	2xG24q3	1,0
42913	NKC-232/16/055		2x32	2xGX24q3	1,0











LED IP43

Kód code код	kód code код	typ type тип	[lm] 3000K	[lm] 4000K	příkon input [W]	T [h]	záruka Guarantee [years]
48436	48936	LED-4L11A07K86/055.000	2950	2950	30		3
48437	48937	LED-6L02A10K86/055.000	3700	3940	43		5*
DIM							
48438	48938	LED-6L02A10K86/055 1-10V.000	3700	3940	43		5
48439	48939	LED-6L02A10K86/055 DALI.000	3700	3940	43		5
S							
48440	48940	LED-4L11A07K86/055 HF.000	2950	2950	30		3
48441	48941	LED-6L02A10K86/055 HF.000	3700	3940	43		5*
NE							
48442	48942	LED-4L11A07K86/055/NK1W.000	2950	2950	30	3,0	3
48443	48943	LED-6L02A10K86/055/NK1W.000	3700	3940	43	3,0	5*

CRATER DL5 IP41

kód/DL4 code/DL4 код/DL4	kód/DL14 code/DL14 код/DL14	kód/DL15 code/DL15 код/DL15	typ type тип	příkon input [W]	objímka socket патрон	T [h]
A						
43710	43726	43742	IN-32K86/055/DL..	3x60	3x E27	
EVG						
43712	43728	43744	E-204K86/055/DL..	22+40	2x2GX13	
43713	43729	43745	E-27K86/055/DL..	2x36	2x2G10	
43714	43730	43746	E-28K86/055/DL..	2x42	2xGX24q4	
DIM						
44126	44131	44136	ES-26K86/055/DL..32W 1-10V	2x32	2xGX24q3	
44127	44132	44137	ES-26K86/055/DL..32W DALI	2x32	2xGX24q3	
44128	44133	44138	ES-28K86/055/DL..1-10V	2x42	2xGX24q4	
44129	44134	44139	ES-28K86/055/DL.. DALI	2x42	2xGX24q4	
S						
43718	43734	43750	IN-22K86/055/DL.. HF	2x60	2x E27	
43719	43735	43751	E-17K86/055/DL.. HF	36	2G10	
NE						
43724	43740	43756	NK-E-36/055/DL..	36	2G10	1,0
43725	43741	43757	NKC-226/13/055/DL..	2x26	2xG24q3	1,0
44130	44135	44140	NKC-232/16/055/DL..	2x32	2xGX24q3	1,0

DRACO 1 IP43

Kód code код	typ type тип	Zdroj source лампа	přikon input [W]	objímka socket патрон	T [h]
A					
42915	IN-12K2/251		60	E27	
VVG					
42916	IN-14K2/251		13	G24d1	
EVG					
42917	E-14K2/251		13	G24q1	
N					
42918	NZ-7/251		7	2G7	1,0
A 					
42923	IN-12DU2/251		60	E27	
EVG 					
42925	E-13DU2/251		9	2G7	
N 					
42926	NZ-7/DU/251		7	2G7	1,0

LED IP43

Kód code код	kód code код	typ type тип	[lm] 3000K	[lm] 4000K	přikon input [W]	T [h]	záruka Guarantee [years]
48444	48944	LED-1L11A07K2/251.000	740	740	9		3
48445	48945	LED-2L02A07K2/251.000	920	990	11		5
N							
	47075	LED-NZ1W/251 4000		100	1	1,0	3

DRACO DL1 IP41

kód/DL4 code/DL4 код/DL4	kód/DL14 code/DL14 код/DL14	kód/DL15 code/DL15 код/DL15	typ type тип	přikon input [W]	objímka socket патрон	T [h]
A						
43760	43772	43784	IN-12K2/251/DL..	60	E27	
EVG						
43762	43774	43786	E-14K2/251/DL..	13	G24q1	
N						
43763	43775	43787	NZ-7/251/DL..	7	2G7	1,0



Ø 220 mm

Náhradní stínítko/spare shade/запасное стекло

Kód/code/код	Typ/Type/тип	D [mm]
20062	251	220

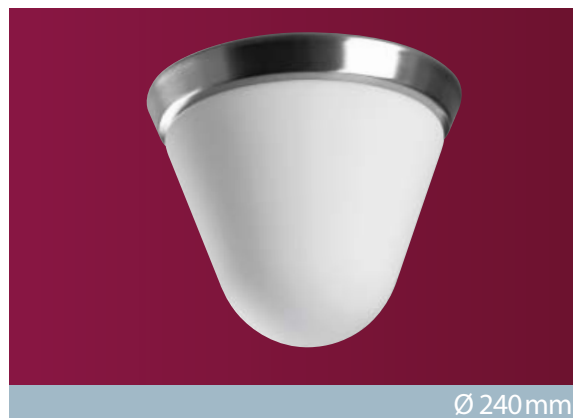
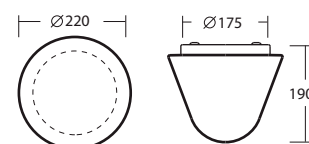

Ø 240 mm

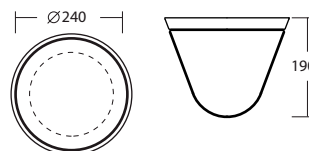

DRACO 2



Ø 280 mm

Náhradní stínítko/spare shade/запасное стекло

Kód/code/код	Typ/Type/тип	D [mm]
20063	252	280

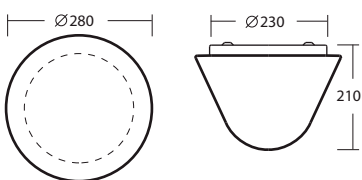

DRACO 2 IP43

Kód code код	typ type тип	Zdroj source лампа	příkon input [W]	objímka socket патрон	T [h]
A					
42927	IN-12K53/252		100	E27	
42928	IN-22K53/252		2x60	2xE27	
VVG					
42929	IN-15K53/252		18	G24d2	
42930	IN-16K53/252		26	G24d3	
42931	IN-24K53/252		2x13	2xG24d1	
EVG					
42933	E-15K53/252		18	G24q2	
42934	E-16K53/252		26	G24q3	
42935	E-24K53/252		2x13	2xG24q1	
S					
42936	IN-12K53/252 HF		60	E27	
42938	E-16K53/252 HF		26	G24q3	
N					
42939	NZ-13/252		13	G24q1	1,0
NE					
42940	NK-E-13/252		13	G24q1	1,0
44141	NK-E-18/252		18	G24q2	1,0
A					
42954	IN-12DU53/252		100	E27	
EVG					
42956	E-14DU53/252		13	G24q1	
N					
42957	NZ-13/DU/252		13	G24q1	1,0

LED IP43

Kód code код	kód code код	typ type тип	[lm]	[lm]	příkon input [W]	T [h]	záruka Guarantee [years]
			3000K	4000K			
48446	48946	LED-1L12A07K53/252.000	980	980	11		3
48447	48947	LED-3L02A07K53/252.000	1380	1470	15		5*
48448	48948	LED-3L02A10K53/252.000	1850	1970	23		5*
DIM							
48449	48949	LED-3L02A10K53/252 1-10V.000	1850	1970	23		5
48450	48950	LED-3L02A10K53/252 DALI.000	1850	1970	23		5
S							
48451	48951	LED-1L12A07K53/252 HF.000	980	980	11		3
48452	48952	LED-3L02A10K53/252 HF.000	1850	1970	23		5
NE							
48453	48953	LED-1L12A07K53/252/NK1W.000	980	980	11	3,0	3
48454	48954	LED-3L02A07K53/252/NK1W.000	1380	1470	15	3,0	5

DRACO DL2 IP41

kód/DL4 code/DL4 код/DL4	kód/DL14 code/DL14 код/DL14	kód/DL15 code/DL15 код/DL15	typ type тип	příkon input [W]	objímka socket патрон	T [h]
A						
43796	43825	43854	IN-12K53/252/DL..	100	E27	
43797	43826	43855	IN-22K53/252/DL..	2x60	2xE27	
EVG						
43801	43830	43859	E-15K53/252/DL..	18	G24q2	
43802	43831	43860	E-16K53/252/DL..	26	G24q3	
43803	43832	43861	E-24K53/252/DL..	2x13	2xG24q1	
S						
43804	43833	43862	IN-12K53/252/DL..HF	60	E27	
43806	43835	43864	E-16K53/252/DL.. HF	26	G24q3	
N						
43807	43836	43865	NZ-13/252/DL..	13	G24q1	1,0
NE						
44142	44143	44144	NK-E-18/252/DL..	18	G24q2	1,0



Ø 305 mm

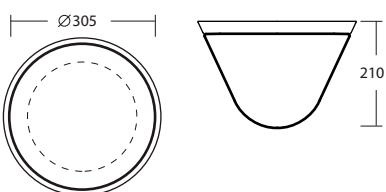

DRACO 3 IP43					
Kód code код	typ type тип	Zdroj source лампа	přikon input [W]	objímka socket патрон	T [h]
A					
42959	IN-12K64/253		100	E27	
42960	IN-22K64/253		2x75	2xE27	
VVG					
42961	IN-16K64/253		26	G24d3	
42962	IN-25K64/253		2x18	2xG24d2	
EVG					
42963	E-16K64/253		26	G24q3	
42964	E-25K64/253		2x18	2xG24q2	
DIM					
42965	ES-25K64/253 1-10V		2x18	2xG24q2	
42967	ES-25K64/253 DALI		2x18	2xG24q2	
S					
42968	IN-12K64/253 HF		75	E27	
42969	E-16K64/253 HF		26	G24q3	
N					
42970	NZ-18/253		18	G24q2	1,0
NE					
42974	NK-E-26/253		26	G24q3	1,0
NES					
44145	NK-E-26/253 HF		26	G24q3	1,0
A					
42989	IN-22DU64/253		2x60	2xE27	
EVG					
42991	E-16DU64/253		26	G24q3	
NE					
42993	NK-E-13/DU/253		13	G24q1	1,0

LED IP43							
Kód code код	kód code код	typ type тип	[lm] 3000K	[lm] 4000K	přikon input [W]	T [h]	záruka Guarantee [years]
48455	48955	LED-1L13A07K64/253 .000	1480	1480	16		3
48456	48956	LED-4L02A07K64/253 .000	1840	1970	20		5*
48457	48957	LED-4L02A10K64/253 .000	2460	2630	30		5*
DIM							
48458	48958	LED-4L02A10K64/253 1-10V .000	2460	2630	30		5
48459	48959	LED-4L02A10K64/253 DALI .000	2460	2630	30		5
S							
48460	48960	LED-1L13A07K64/253 HF .000	1480	1480	16		3
48461	48961	LED-4L02A10K64/253 HF .000	2460	2630	30		5*
NE							
48462	48962	LED-1L13A07K64/253/NK1W .000	1480	1480	16	3,0	3
48463	48963	LED-4L02A10K64/253/NK1W .000	2460	2630	30	3,0	5*
NES							
48464	48964	LED-1L13A07K64/253/NK1W HF .000	1480	1480	16	3,0	3
48465	48965	LED-4L02A10K64/253/NK1W HF .000	2460	2630	30	3,0	5*

DRACO DL3 IP41						
kód/DL4 code/DL4 код/DL4	kód/DL14 code/DL14 код/DL14	kód/DL15 code/DL15 код/DL15	typ type тип	přikon input [W]	objímka socket патрон	T [h]
A						
43883	43918	43953	IN-12K64/253/DL..	100	E27	
43884	43919	43954	IN-22K64/253/DL..	2x75	2xE27	
EVG						
43887	43922	43957	E-16K64/253/DL..	26	G24q3	
43888	43923	43958	E-25K64/253/DL..	2x18	2xG24q2	
DIM						
43889	43924	43959	ES-25K64/253/DL.. 1-10V	2x18	2xG24q2	
43891	43926	43961	ES-25K64/253/DL.. DALI	2x18	2xG24q2	
S						
43892	43927	43962	IN-12K64/253/DL.. HF	75	E27	
43893	43928	43963	E-16K64/253/DL.. HF	26	G24q3	
N						
43894	43929	43964	NZ-18/253/DL..	18	G24q2	1,0
NE						
43897	43932	43967	NK-E-18/253/DL..	18	G24q2	1,0
43898	43933	43968	NK-E-26/253/DL..	26	G24q3	1,0
NES						
55307	55308	55309	NK-E-26/253/DL.. HF	26	G24q3	1,0



Ø 350 mm

Náhradní stínítko/spare shade/запасное стекло

Kód/code/код	Typ/Type/тип	D [mm]
20064	253	350

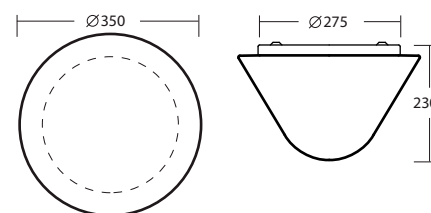

Ø 385 mm

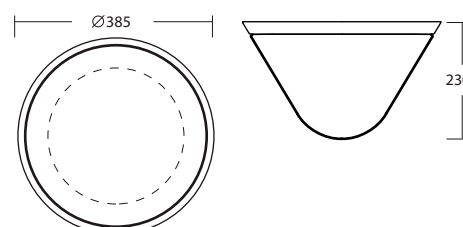

DRACO 4



Ø 420 mm

Náhradní stínítko/spare shade/запасное стекло

Kód/code/код	Typ/Type/тип	D [mm]
20065	254	420

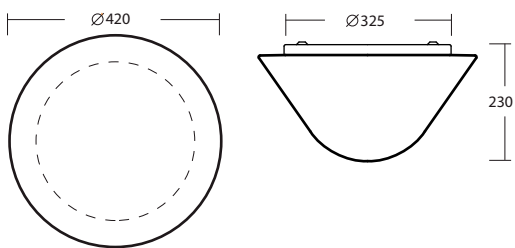

Ø 460 mm

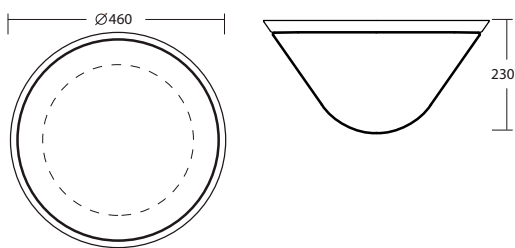

DRACO 4 IP43

Kód code код	typ type тип	Zdroj source лампа	příkon input [W]	objímka socket патрон	T [h]
A					
42995	IN-22K74/254		2x75	2x E27	
VVG					
42996	IN-17K74/254		36	2G10	
42997	IN-26K74/254		2x26	2xG24d3	
EVG					
42998	E-17K74/254		36	2G10	
42999	E-26K74/254		2x26	2xG24q3	
43000	E-26K74/254 32W		2x32	2xGX24q3	
DIM					
43001	ES-26K74/254 1-10V		2x26	2xG24q3	
43003	ES-26K74/254 DALI		2x26	2xG24q3	
S					
43004	IN-22K74/254 HF		2x60	2xE27	
43005	E-17K74/254 HF		36	2G10	
NE					
43010	NK-E-36/254		36	2G10	1,0
43011	NKC-226/13/254		2x26	2xG24q3	1,0















LED IP43

Kód code код	kód code код	typ type тип	[lm] 3000K	[lm] 4000K	příkon input [W]	T [h]	záruka Guarantee [years]
3000K 4000K							
48466	48966	LED-1L14A07K75/254.000	1970	1970	21		3
48467	48967	LED-5L02A10K75/254.000	3080	3280	37		5*
DIM							
48468	48968	LED-5L02A10K75/254 1-10V.000	3080	3280	37		5
48469	48969	LED-5L02A10K75/254 DALI.000	3080	3280	37		5
S							
48470	48970	LED-1L14A07K75/254 HF.000	1970	1970	21		3
48471	48971	LED-5L02A10K75/254 HF.000	3080	3280	37		5*
NE							
48472	48972	LED-1L14A07K75/254/NK1W.000	1970	1970	21	3,0	3
48473	48973	LED-5L02A10K75/254/NK1W.000	3080	3280	37	3,0	5*

DRACO DL4 IP41

kód/DL4 code/DL4 код/DL4	kód/DL14 code/DL14 код/DL14	kód/DL15 code/DL15 код/DL15	typ type тип	příkon input [W]	objímka socket патрон	T [h]
A						
44300	44317	44334	IN-22K74/254/DL..	2x75	2x E27	
EVG						
44303	44320	44337	E-17K74/254/DL..	36	2G10	
44304	44321	44338	E-26K74/254/DL..	2x26	2xG24q3	
44305	44322	44339	E-26K74/254/DL.. 32W	2x32	2xGX24q3	
DIM						
44306	44323	44340	ES-26K74/254/DL.. 1-10	2x26	2xG24q3	
44308	44325	44342	ES-26K74/254/DL..DALI	2x26	2xG24q3	
S						
44309	44326	44343	IN-22K74/254/DL.. HF	2x60	2x E27	
44310	44327	44344	E-17K74/254/DL.. HF	36	2G10	
NE						
44315	44332	44349	NK-E-36/254/DL..	36	2G10	1,0
44316	44333	44350	NKC-226/13/254/DL..	2x26	2xG24q3	1,0

DRACO 5 IP43

Kód code код	typ type тип	Zdroj source лампа	přikon input [W]	objímka socket патрон	T [h]
A					
43012	IN-32K86/255		3x60	3x E27	
VVG					
43013	IN-27K86/255		2x36	2x2G10	
EVG					
43014	E-204K86/255		22+40	2x2GX13	
43015	E-27K86/255		2x36	2x2G10	
43016	E-28K86/255		2x42	2xGX24q4	
DIM					
44146	ES-26K86/255 32W 1-10V		2x32	2xGX24q3	
44147	ES-26K86/255 32W DALI		2x32	2xGX24q3	
44148	ES-28K86/255 1-10V		2x42	2xGX24q4	
44149	ES-28K86/255 DALI		2x42	2xGX24q4	
S					
43020	IN-22K86/255 HF		2x60	2x E27	
43021	E-17K86/255 HF		36	2G10	
NE					
43026	NK-E-36/255		36	2G10	1,0
43027	NKC-226/13/255		2x26	2xG24q3	1,0
43028	NKC-232/16/255		2x32	2xGX24q3	1,0

LED IP43

Kód code код	kód code код	typ type тип	[lm] 3000K	[lm] 4000K	přikon input [W]	T [h]	záruka Guarantee [years]
48474	48974	LED-4L11A07K86/255.000	2950	2950	30		3
48475	48975	LED-6L02A10K86/255.000	3700	3940	43		5*
DIM							
48476	48976	LED-6L02A10K86/255 1-10V.000	3700	3940	43		5
48477	48977	LED-6L02A10K86/255 DALI.000	3700	3940	43		5
S							
48478	48978	LED-4L11A07K86/255 HF.000	2950	2950	30		3
48479	48979	LED-6L02A10K86/255 HF.000	3700	3940	43		5*
NE							
48480	48980	LED-4L11A07K86/255/NK1W.000	2950	2950	30	3,0	3
48481	48981	LED-6L02A10K86/255/NK1W.000	3700	3940	43	3,0	5*

DRACO DL5 IP41

kód/DL4 code/DL4 код/DL4	kód/DL14 code/DL14 код/DL14	kód/DL15 code/DL15 код/DL15	typ type тип	přikon input [W]	objímka socket патрон	T [h]
A						
44351	44367	44383	IN-32K86/255/DL..	3x60	3x E27	
EVG						
44353	44369	44385	E-204K86/255/DL..	22+40	2x2GX13	
44354	44370	44386	E-27K86/255/DL..	2x36	2x2G10	
44355	44371	44387	E-28K86/255/DL..	2x42	2xGX24q4	
DIM						
44150	44155	44160	ES-26K86/255/DL..32W 1-10V	2x32	2xGX24q3	
44151	44156	44161	ES-26K86/255/DL..32W DALI	2x32	2xGX24q3	
44152	44157	44162	ES-28K86/255/DL..1-10V	2x42	2xGX24q4	
44153	44158	44163	ES-28K86/255/DL..DALI	2x42	2xGX24q4	
S						
44359	44375	44391	IN-22K86/255/DL.. HF	2x60	2x E27	
44360	44376	44392	E-17K86/255/DL.. HF	36	2G10	
NE						
44365	44381	44397	NK-E-36/255/DL..	36	2G10	1,0h
44366	44382	44398	NKC-226/13/255/DL..	2x26	2xG24q3	1,0h
44154	44159	44164	NKC-232/16/255/DL..	2x32	2xGX24q3	1,0h



Ø 490 mm

Náhradní stínítko/spare shade/запасное стекло

Kód/code/код	Typ/Type/тип	D [mm]
20066	255	490

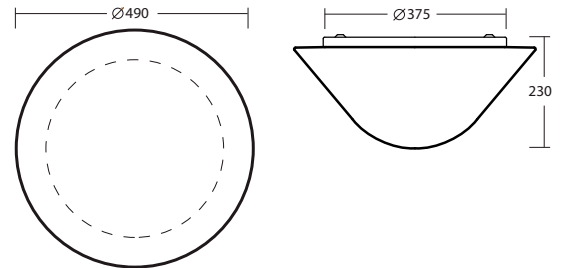

Ø 535 mm

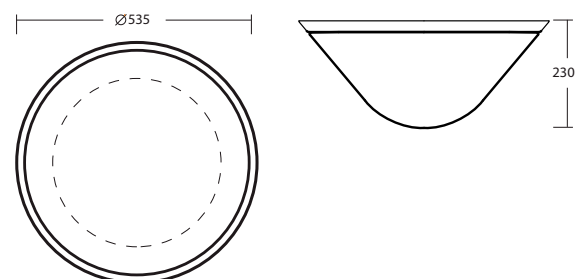

AURA 6,7,8,10,11

ELSA 1,2,3,4,5,6



POPIS SVÍTIDEL

Svítidla tvoří montura z kovu a skleněné stínítko

Držení stínítka

- bajonetové

Montáž

- na stěnu nebo na strop

ENEC

- certifikát ENEC splňují svítidla s elektronickým předřadníkem (bez senzoru a nouzového režimu)

DESCRIPTION OF THE LIGHTING FITTINGS

The lighting fitting consist of the metal fixture and glass shade

Shade attachment

- with bayonet

Assembly

- to the ceiling or on the wall

ENEC

- Light fittings with electrical ballast comply with ENEC (without sensor and emergency mode)

ОПИСАНИЕ СВЕТИЛЬНИКОВ

Светильники состоят из металлического основания и стеклянного светорассеивателя.

Крепление рассеивателя

- резьбовое соединение «байонет»

Установка

- настенный, потолочный

ENEC

- сертификат ENEC распространяется на светильники с ЭПРА (без датчика движения и аварийного режима)

BESCHREIBUNG DER LEUCHTEN

Die Leuchten bestehen aus einer Stahlblechmatur und einer Glasabdeckung.

Halterung der Abdeckscheibe - Bajonettverschluss

Montage

- als Wand - oder Deckenleuchte

ENEC

- Dem Prüfzeugnis ENEC entsprechen die Leuchten mit EVG (ohne Sensor und Notbetrieb)

DESCRIPTION DES LUMINAIRES

Les luminaires d'intérieur se composent d'une monture métallique et d'un abat-jour en verre

Fixation de l'abat-jour

- fixation par baïonnette

Montage

- sur un plafond ou sur un mur

ENEC

- Le certificat ENEC certifie la conformité des luminaires à ballast électronique (sans capteurs et sans régime de sécurité)

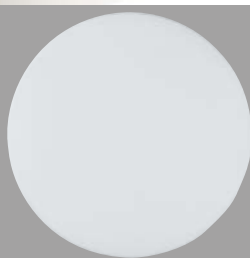
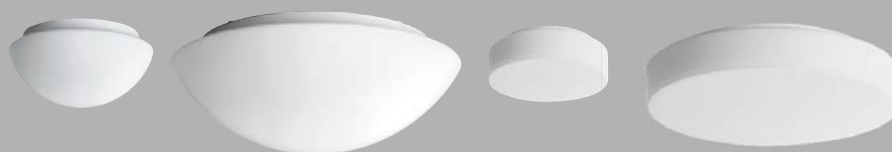



AURA D 6,7,8,10,11
ELSA D 1,2,3,4

POPIS SVÍTIDEL S DEKORATIVNÍMI LÍMCI

Svítidla tvoří montura z kovu, skleněné stínítko a dekorativní kovový límeček

Dekorativní límeček - volně podložený pod stínítkem

Upozornění: veškerá svítidla s dekorativními límci lze vybavit i LED zdroji – viz AURA 6-11

DESCRIPTION OF THE LIGHTING FITTINGS WITH DECORATIVE RINGS

The lighting fittings consist of the metal fixture, the glass shade and the decorative metal ring

Decorative ring - is freely placed under the shade

NOTICE: it is possible to equip all the light fittings with decorative rings with LED-sources too – see AURA 6-11

ОПИСАНИЕ СВЕТИЛЬНИКОВ

Светильники состоят из металлического основания, стеклянного светорассеивателя и декоративного металлического кольца

Декоративное кольцо - установлено свободно под светорассеивателем

Внимание: все светильники с декоративными кольцами могут быть изготовлены со светодиодами – см. AURA 6-11

BESCHREIBUNG DER LEUCHTEN MIT DEKORATIVEM METALLRING

Die Leuchten bestehen aus einer Stahlblecharmatur, einer Glasabdeckung und einem dekorativen Metallring

Der dekorative Metallring - ist der Abdeckscheibe frei untergesetzt

Hinweis: Sämtliche Leuchten mit dekorativen Ringen können auch mit LED-Lampen ausgestattet werden -siehe AURA 6-11

DESCRIPTION DES LUMINAIRES AVEC COL DÉCORATIF

Les luminaires d'intérieur se composent d'une monture métallique, d'un abat-jour en verre et d'un col décoratif

Col décoratif - est placé sous l'abat-jour

Remarque: Tous les luminaires avec col décoratif peuvent également être équipés de LED- voir AURA 6-11



Dekorativní límeček / Decorative ring / Декоративное кольцо (цвет) / Dekorativer Ring / col décoratif

H4, X4 bílá/white/белый/Weiß/blanche

H11, X11 chrom/chrome/хром/Chrom/chrome

H12, X12 mosaz/brass/латунь/Messing/laiton

H13, X13 matný chrom/matt chrome/матовый хром/Mattchrom/chrome mat/



AURA 6



Ø 200 mm

Náhradní stínítko/spare shade/запасное стекло

Kód/code/код	Typ/Type/тип	D [mm]
20006	011	200

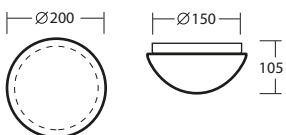

220x220

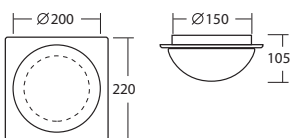

Ø 220 mm

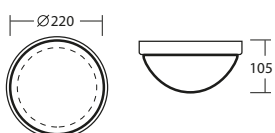

AURA 6 IP20, IP44

Kód code код	typ IP20 type IP20 тип IP20	Kód code код	typ IP44 type IP44 тип IP44	příkon input [W]	objímka socket патрон	T [h]
--------------	-----------------------------	--------------	-----------------------------	------------------	-----------------------	-------

A

40104	IN-12B11/011	42702	IN-12BT11/011	60	E27	
-------	--------------	-------	---------------	----	-----	--

LED IP44

Kód code код	kód code код	typ type тип	[lm]	[lm]	příkon input [W]	T [h]	záruka Guarantee [years]
			3000K	4000K			
47461	47961	LED-1L11A07BT11/011.000	740	740	9		3
47462	47962	LED-2L02A07BT11/011.000	920	990	11		5

N

-	47095	LED-NZ1W/011 4000	-	100	1	1,0	3
---	-------	-------------------	---	-----	---	-----	---

AURA D6 - H IP20

kód/H4 code/H4 код/H4	kód/H11 code/H11 код/H11	kód/H12 code/H12 код/H12	kód/H13 code/H13 код/H13	typ type тип	příkon input [W]	objímka socket патрон
-----------------------	--------------------------	--------------------------	--------------------------	--------------	------------------	-----------------------

A

40950	40952	40954	40956	IN-12B11/011/H..	60	E27
-------	-------	-------	-------	------------------	----	-----

AURA D6 - X IP20

kód/X4 code/X4 код/X4	kód/X11 code/X11 код/X11	kód/X12 code/X12 код/X12	kód/X13 code/X13 код/X13	typ type тип	příkon input [W]	objímka socket патрон
-----------------------	--------------------------	--------------------------	--------------------------	--------------	------------------	-----------------------

A

40966	40968	40970	40972	IN-12B11/011/X..	60	E27
-------	-------	-------	-------	------------------	----	-----

AURA 7 IP20, IP44

Kód IP20 code IP20 код IP20	typ type тип	Kód IP44 code IP44 код IP44	typ type тип	příkon input [W]	objímka socket патрон	T [h]
A						
40106	IN-12B12/012	42703	IN-12BT12/012	75	E27	
VVG						
40109	IN-14B12/012	42704	IN-14BT12/012	13	G24d1	
EVG						
40111	E-14B12/012	42705	E-14BT12/012	13	G24q1	
42700	E-15B12/012	42706	E-15BT12/012	18	G24q2	
N						
40112	NZ-7/012	42707	NZ-7/T/012	7	2G7	1,0

LED IP44

Kód code код	kód code код	typ type тип	[lm] 3000K	[lm] 4000K	příkon input [W]	T [h]	záruka Guarantee [years]
47463	47963	LED-1L12A07BT12/012.000	980	980	11		3
47464	47964	LED-3L02A07BT12/012.000	1380	1470	15		5
S							
47465	47965	LED-1L12A07BT12/012.HF.000	980	980	11		3
47466	47966	LED-3L02A07BT12/012.HF.000	1380	1470	15		5
N							
-	47967	LED-NZ1W/012.4000		100	1	3,0	3

AURA D7 - H IP20

kód/H4 code/H4 код/H4	kód/H11 code/H11 код/H11	kód/H12 code/H12 код/H12	kód/H13 code/H13 код/H13	typ type тип	příkon input [W]	objímka socket патрон	T [h]
A							
40974	40981	40988	40995	IN-12B12/012/H..	60	E27	
EVG							
40979	40986	40993	41000	E-14B12/012/H..	13	G24q1	
N							
40980	40987	40994	41001	NZ-7/012/H..	7	2G7	1,0

AURA D7 - X IP20

kód/X4 code/X4 код/X4	kód/X11 code/X11 код/X11	kód/X12 code/X12 код/X12	kód/X13 code/X13 код/X13	typ type тип	příkon input [W]	objímka socket патрон	T [h]
A							
41030	41037	41044	41051	IN-12B12/012/X..	75	E27	
EVG							
41035	41042	41049	41056	E-14B12/012/X..	13	G24q1	
N							
41036	41043	41050	41057	NZ-7/012/X..	7	2G7	1,0



Náhradní stínítko/spare shade/запасное стекло

Kód/code/код	Typ/Type/тип	D [mm]
20007	012	250

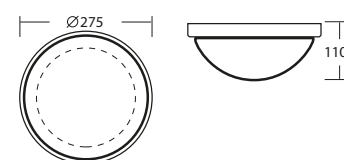
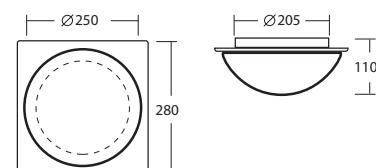
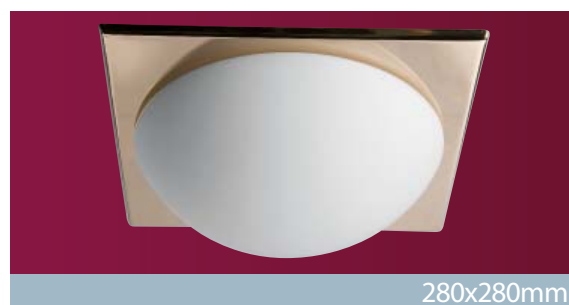
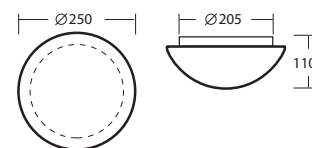

AURA 8



Ø 300 mm

Náhradní stínítko/spare shade/запасное стекло

Kód/code/код	Typ/Type/тип	D [mm]
20008	013	300

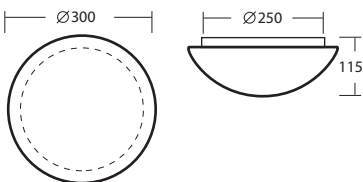

AURA 8 IP20, IP44

Kód IP20 code IP20 код IP20	typ type тип	Kód IP44 code IP44 код IP44	typ type тип	příkon input [W]	objímka socket патрон	T [h]
-----------------------------------	--------------------	-----------------------------------	--------------------	------------------------	-----------------------------	----------

A						
40113	IN-12B13/013	42708	IN-12BT13/013	100	E27	
40114	IN-22B13/013	42709	IN-22BT13/013	2x60	2x E27	

VVG						
40116	IN-15B13/013	42710	IN-15BT13/013	18	G24d2	
40117	IN-16B13/013	42711	IN-16BT13/013	26	G24d3	
40118	IN-24B13/013	42712	IN-24BT13/013	2x13	2xG24d1	

EVG						
40120	E-15B13/013	42713	E-15BT13/013	18	G24q2	
40121	E-16B13/013	42714	E-16BT13/013	26	G24q3	
40122	E-24B13/013	42715	E-24BT13/013	2x13	2xG24q1	
42701	E-25B13/013	42716	E-25BT13/013	2x18	2xG24q2	

S						
46107	IN-12B13/013 HF	42720	IN-12BT13/013 HF	60	E27	
46146	E-16B13/013 HF	42721	E-16BT13/013 HF	26	G24q3	

N						
40124	NZ-13/013	42722	NZ-13/T/013	13	G24q1	1,0

NE						
40125	NK-E-13/013	42723	NK-E-13/T/013	13	G24q1	1,0
46405	NK-E-18/013	46435	NK-E-18/T/013	18	G24q2	1,0

LED IP44

Kód code код	kód code код	typ type тип	[lm] 3000K	[lm] 4000K	příkon input [W]	T [h]	záruka Guarantee [years]
3000K	4000K						
47468	47968	LED-1L13A07BT13/013.000	1480	1480	16		3
47469	47969	LED-3L02A10BT13/013.000	1850	1970	23		5*

DIM							
47470	47970	LED-3L02A10BT13/013 1-10V.000	1850	1970	23		5
47471	47971	LED-3L02A10BT13/013 DALI.000	1850	1970	23		5

S							
47472	47972	LED-1L13A07BT13/013 HF.000	1480	1480	16		3
47473	47973	LED-3L02A10BT13/013 HF.000	1850	1970	23		5*

NE							
47474	47974	LED-1L13A07BT13/013/NK1W.000	1480	1480	16	3,0	3
47475	47975	LED-3L02A10BT13/013/NK1W.000	1850	1970	23	3,0	5



Ø 325 mm

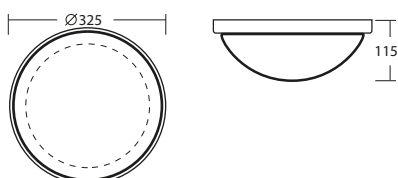

AURA D8 - X IP20

kód/X4 code/X4 код/X4	kód/X11 code/X11 код/X11	kód/X12 code/X12 код/X12	kód/X13 code/X13 код/X13	typ type тип	příkon input [W]	objímka socket патрон	T [h]
-----------------------------	--------------------------------	--------------------------------	--------------------------------	--------------------	------------------------	-----------------------------	----------

A							
41110	41123	41136	41149	IN-12B13/013/X..	100	E27	
41111	41124	41137	41150	IN-22B13/013/X..	2x60	2x E27	

EVG							
41117	41130	41143	41156	E-15B13/013/X..	18	G24q2	
41118	41131	41144	41157	E-16B13/013/X..	26	G24q3	
41119	41132	41145	41158	E-24B13/013/X..	2x13	2xG24q1	
46163	46164	46165	46166	E-25B13/013/X..	2x18	2xG24q2	

S							
46167	46169	46171	46173	IN-12B13/013/X.. HF	60	E27	
46168	46170	46172	46174	E-16B13/013/X.. HF	26	G24q3	

N							
41121	41134	41147	41160	NZ-13/013/X..	13	G24q1	1,0

NE							
41122	41135	41148	41161	NK-E-13/013/X..	13	G24q1	1,0
43991	43992	43993	43994	NK-E-18/013/X..	18	G24q2	1,0

AURA 10 IP20, IP44

Kód IP20 code IP20 код IP20	typ type тип	Kód IP44 code IP44 код IP44	typ type тип	přikon input [W]	objímka socket патрон	T [h]
-----------------------------------	--------------------	-----------------------------------	--------------------	------------------------	-----------------------------	----------

A						
42725	IN-12B14/014	42741	IN-12BT14/014	100	E27	
42726	IN-22B14/014	42742	IN-22BT14/014	2x75	2xE27	

VVG						
42727	IN-16B14/014	42743	IN-16BT14/014	26	G24d3	
42728	IN-25B14/014	42744	IN-25BT14/014	2x18	2xG24d2	

EVG						
42729	E-16B14/014	42745	E-16BT14/014	26	G24q3	
42730	E-25B14/014	42746	E-25BT14/014	2x18	2xG24q2	
42731	E-26B14/014	42747	E-26BT14/014	2x26	2xG24q3	

DIM						
42732	ES-25B14/014 1-10V	42748	ES-25BT14/014 1-10V	2x18	2xG24q2	
42734	ES-25B14/014 DALI	42750	ES-25BT14/014 DALI	2x18	2xG24q2	

S						
42735	IN-12B14/014 HF	42751	IN-12BT14/014 HF	75	E27	
42736	E-16B14/014 HF	42752	E-16BT14/014 HF	26	G24q3	

NE						
42739	NK-E-26/014	42755	NK-E-26/T/014	26	G24q3	1,0
42740	NKC-218/13/014	42756	NKC-218/13/T/014	2x18	2xG24q2	1,0
46420	NKC-226/13/014	46467	NKC-226/13/T/014	2x26	2xG24q3	1,0

NES						
46379	NK-E-26/014 HF	44039	NK-E-26/T/014 HF	26	G24q3	1,0

LED IP44

Kód code код	kód code код	typ type тип	[lm]	[lm]	přikon input [W]	T [h]	záruka Guarantee [years]
3000K	4000K		3000K	4000K			
47476	47976	LED-1L14A07BT14/014.000	1970	1970	21		3
47477	47977	LED-4L02A10BT14/014.000	2460	2630	30		5*

DIM							
47478	47978	LED-4L02A10BT14/014 1-10V.000	2460	2630	30		5
47479	47979	LED-4L02A10BT14/014 DALI.000	2460	2630	30		5

S							
47480	47980	LED-1L14A07BT14/014 HF.000	1970	1970	21		3
47481	47981	LED-4L02A10BT14/014 HF.000	2460	2630	30		5*

NE							
47482	47982	LED-1L14A07BT14/014/NK1W.000	1970	1970	21		3
47483	47983	LED-4L02A10BT14/014/NK1W.000	2460	2630	30		5*

NES							
47484	47984	LED-1L14A07BT14/014/NK1W HF.000	1970	1970	21	3,0	3
47485	47985	LED-4L02A10BT14/014/NK1W HF.000	2460	2630	30	3,0	5*

AURA D10 - X IP20

kód/X4 code/X4 код/X4	kód/X11 code/X11 код/X11	kód/X12 code/X12 код/X12	kód/X13 code/X13 код/X13	typ type тип	přikon input [W]	objímka socket патрон	T [h]
-----------------------------	--------------------------------	--------------------------------	--------------------------------	--------------------	------------------------	-----------------------------	----------

A							
44400	44416	44432	44448	IN-12B14/014/X..	100	E27	
44401	44417	44433	44449	IN-22B14/014/X..	2x75	2xE27	

EVG							
44404	44420	44436	44452	E-16B14/014/X..	26	G24q3	
44405	44421	44437	44453	E-25B14/014/X..	2x18	2xG24q2	
44406	44422	44438	44454	E-26B14/014/X..	2x26	2xG24q3	

DIM							
44407	44423	44439	44455	ES-25B14/014/X.. 1-10V	2x18	2xG24q2	
44409	44425	44441	44457	ES-25B14/014/X.. DALI	2x18	2xG24q2	

S							
44410	44426	44442	44458	IN-12B14/014/X.. HF	75	E27	
44411	44427	44443	44459	E-16B14/014/X.. HF	26	G24q3	

NE							
44414	44430	44446	44462	NK-E-26/014/X..	26	G24q3	1,0
44415	44431	44447	44463	NKC-218/13/014/X..	2x18	2xG24q2	1,0
44040	44042	44044	44046	NKC-226/13/014/X..	2x26	2xG24q3	1,0

NES							
44041	44043	44045	44047	NK-E-26/014/X.. HF	26	G24q3	1,0



Náhradní stínítko/spare shade/запасное стекло

Kód/code/код	Typ/Type/тип	D [mm]
20055	014	360

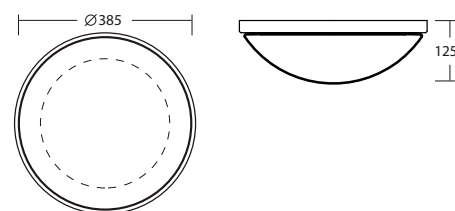
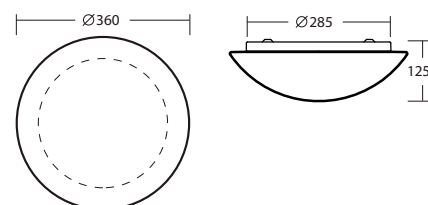

AURA 11

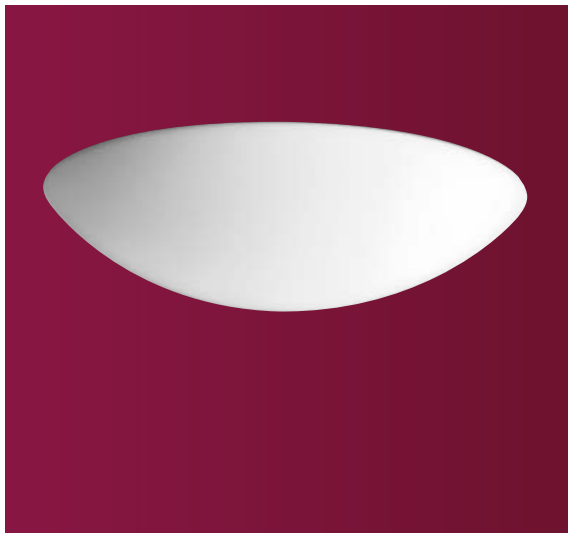

Ø 420 mm

Náhradní stínítko/spare shade/запасное стекло

Kód/code/код	Typ/Type/тип	D [mm]
20056	015	420

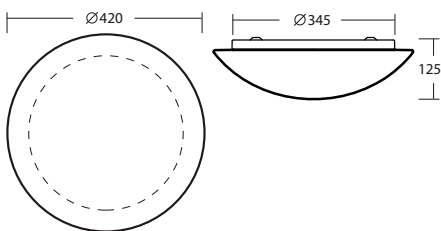

Ø 445 mm

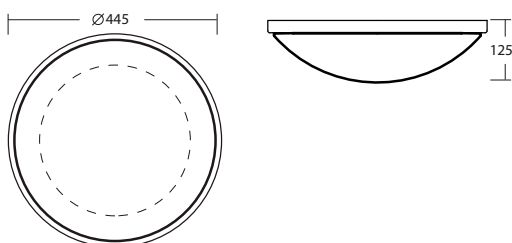

AURA 11 IP20, IP44

Kód IP20 code IP20 код IP20	typ type тип	Kód IP44 code IP44 код IP44	typ type тип	příkon input [W]	objímka socket патрон	T [h]
-----------------------------------	--------------------	-----------------------------------	--------------------	------------------------	-----------------------------	----------

42757	IN-22B15/015	42775	IN-22BT15/015	2x75	2xE27	
-------	--------------	-------	---------------	------	-------	--

VVG						
42758	IN-17B15/015	42776	IN-17BT15/015	36	2G10	
42759	IN-26B15/015	42777	IN-26BT15/015	2x26	2xG24d3	

EVG						
42760	E-17B15/015	42778	E-17BT15/015	36	2G10	
42761	E-26B15/015	42779	E-26BT15/015	2x26	2xG24q3	
42762	E-26B15/015 32W	42780	E-26BT15/015 32W	2x32	2xGX24q3	
42763	E-204B15/015	42781	E-204BT15/015	22+40	2xGX13	

DIM						
42764	ES-26B15/015 1-10V	42782	ES-26BT15/015 1-10V	2x26	2xG24q3	
42766	ES-26B15/015 DALI	42784	ES-26BT15/015 DALI	2x26	2xG24q3	

S						
42767	IN-22B15/015 HF	42785	IN-22BT15/015 HF	2x60	2xE27	
42768	E-17B15/015 HF	42786	E-17BT15/015 HF	36	2G10	

NE						
42773	NK-E-36/015	42791	NK-E-36/T/015	36	2G10	1,0
42774	NKC-226/13/015	42792	NKC-226/13/T/015	2x26	2xG24q3	1,0

LED IP44

Kód code код	kód code код	typ type тип	[lm] 3000K	[lm] 4000K	příkon input [W]	T [h]	záruka Guarantee [years]
47486	47986	LED-4L11A07BT15/015 .000	2950	2950	30		3
47487	47987	LED-5L02A10BT15/015 .000	3080	3280	37		5*

DIM							
47488	47988	LED-5L02A10BT15/015 1-10V .000	3080	3280	37		5
47489	47989	LED-5L02A10BT15/015 DALI .000	3080	3280	37		5

S							
47490	47990	LED-4L11A07BT15/015 HF .000	2950	2950	30		3
47491	47991	LED-5L02A10BT15/015 HF .000	3080	3280	37		5*

NE							
47492	47992	LED-4L11A07BT15/015/NK1W .000	2950	2950	30	3,0	3
47493	47993	LED-5L02A10BT15/015/NK1W .000	3080	3280	37	3,0	5*

AURA D11 - X IP20

kód/X4 code/X4 код/X4	kód/X11 code/X11 код/X11	kód/X12 code/X12 код/X12	kód/X13 code/X13 код/X13	typ type тип	příkon input [W]	objímka socket патрон	T [h]
-----------------------------	--------------------------------	--------------------------------	--------------------------------	--------------------	------------------------	-----------------------------	----------

44464	44482	44500	44518	IN-22B15/015/X..	2x75	2xE27	
-------	-------	-------	-------	------------------	------	-------	--

EVG							
44467	44485	44503	44521	E-17B15/015/X..	36	2G10	
44468	44486	44504	44522	E-26B15/015/X..	2x26	2xG24q3	
44469	44487	44505	44523	E-26B15/015/X.. 32W	2x32	2xGX24q3	
44470	44488	44506	44524	E-204B15/015/X..	22+40	2xGX13	

DIM							
44471	44489	44507	44525	ES-26B15/015/X.. 1-10V	2x26	2xG24q3	
44473	44491	44509	44527	ES-26B15/015/X.. DALI	2x26	2xG24q3	

S							
44474	44492	44510	44528	IN-22B15/015/X.. HF	2x60	2xE27	
44475	44493	44511	44529	E-17B15/015/X.. HF	36	2G10	

NE							
44480	44498	44516	44534	NK-E-36/015/X..	36	2G10	1,0
44481	44499	44517	44535	NKC-226/13/015/X..	2x26	2xG24q3	1,0



ELSA 1

NOVINKA/NEW



Ø 250 mm

Náhradní stínítko/spare shade/запасное стекло

Kód/code/код	Typ/Type/тип	D [mm]
20080	023	250

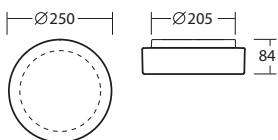

ELSA 1 IP20, IP44

Kód IP20 code IP20 код IP20	typ type тип	Kód IP44 code IP44 код IP44	typ type тип	příkon input [W]	objímka socket патрон	T [h]
-----------------------------------	--------------------	-----------------------------------	--------------------	------------------------	-----------------------------	----------

44700	IN-12B12/023	44705	IN-12BT12/023	75	E27	
-------	--------------	-------	---------------	----	-----	--

44701	IN-14B12/023	44706	IN-14BT12/023	13	G24d1	
-------	--------------	-------	---------------	----	-------	--

44702	E-14B12/023	44707	E-14BT12/023	13	G24q1	
44703	E-15B12/023	44708	E-15BT12/023	18	G24q2	

44704	NZ-7/023	44709	NZ-7/T/023	7	2G7	1,0
-------	----------	-------	------------	---	-----	-----

LED IP44

Kód code код	kód code код	typ type тип	[lm] 3000K	[lm] 4000K	příkon input [W]	T [h]	záruka Guarantee [years]
49270	49770	LED-1L12A07BT12/023.000	980	980	11		3
49271	49771	LED-3L02A07BT12/023.000	1380	1470	15		5*

49272	49772	LED-1L12A07BT12/023 HF.000	980	980	11		3
49273	49773	LED-3L02A07BT12/023 HF.000	1380	1470	15		5*

-	49774	LED-NZ1W/023 4000		100	1	3,0	3
---	-------	-------------------	--	-----	---	-----	---

NOVINKA/NEW



Ø 275 mm

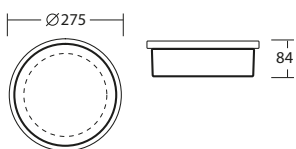

ELSA D-1 IP20

kód/X4 code/X4 код/X4	kód/X11 code/X11 код/X11	kód/X12 code/X12 код/X12	kód/X13 code/X13 код/X13	typ type тип	příkon input [W]	objímka socket патрон	T [h]
-----------------------------	--------------------------------	--------------------------------	--------------------------------	--------------------	------------------------	-----------------------------	----------

44710	44711	44712	44713	IN-12B12/023/X..	75	E27	
-------	-------	-------	-------	------------------	----	-----	--

44718	44719	44720	44721	E-14B12/023/X..	13	G24q1	
-------	-------	-------	-------	-----------------	----	-------	--

44722	44723	44724	44725	NZ-7/023/X..	7	2G7	1,0
-------	-------	-------	-------	--------------	---	-----	-----

ELSA 2 IP20, IP44

Kód IP20 code IP20 код IP20	typ type тип	Kód IP44 code IP44 код IP44	typ type тип	přikon input [W]	objímka socket патрон	T [h]
A						
44726	IN-12B13/025	44740	IN-12BT13/025	100	E27	
44727	IN-22B13/025	44741	IN-22BT13/025	2x60	2x E27	
VVG						
44728	IN-15B13/025	44742	IN-15BT13/025	18	G24d2	
44729	IN-16B13/025	44743	IN-16BT13/025	26	G24d3	
44730	IN-24B13/025	44744	IN-24BT13/025	2x13	2xG24d1	
EVG						
44731	E-15B13/025	44745	E-15BT13/025	18	G24q2	
44732	E-16B13/025	44746	E-16BT13/025	26	G24q3	
44733	E-24B13/025	44747	E-24BT13/025	2x13	2xG24q1	
44734	E-25B13/025	44748	E-25BT13/025	2x18	2xG24q2	
S						
44735	IN-12B13/025 HF	44749	IN-12BT13/025 HF	60	E27	
44736	E-16B13/025 HF	44750	E-16BT13/025 HF	26	G24q3	
N						
44737	NZ-13/025	44751	NZ-13/T/025	13	G24q1	1,0
NE						
44738	NK-E-13/025	44752	NK-E-13/T/025	13	G24q1	1,0
44739	NK-E-18/025	44753	NK-E-18/T/025	18	G24q2	1,0

LED IP44

Kód code код	kód code код	typ type тип	[lm] 3000K	[lm] 4000K	přikon input [W]	T [h]	záruka Guarantee [years]
49275	49775	LED-1L13A07BT13/025 .000	1480	1480	16		3
49276	49776	LED-3L02A10BT13/025 .000	1850	1970	23		5*
DIM							
49277	49777	LED-3L02A10BT13/025 1-10V .000	1850	1970	23		5
49278	49778	LED-3L02A10BT13/025 DALI .000	1850	1970	23		5
S							
49279	49779	LED-1L13A07BT13/025 HF .000	1480	1480	16		3
49280	49780	LED-3L02A10BT13/025HF .000	1850	1970	23		5*
NE							
49281	49781	LED-1L13A07BT13/025/NK1W .000	1480	1480	16	3,0	3
49282	49782	LED-3L02A10BT13/025/NK1W .000	1850	1970	23	3,0	5

ELSA D2 IP20

kód/X4 code/X4 код/X4	kód/X11 code/X11 код/X11	kód/X12 code/X12 код/X12	kód/X13 code/X13 код/X13	typ type тип	přikon input [W]	objímka socket патрон	T [h]
A							
44754	44755	44756	44757	IN-12B13/025/X..	100	E27	
44758	44759	44760	44761	IN-22B13/025/X..	2x60	2x E27	
EVG							
44762	44763	44764	44765	E-15B13/025/X..	18	G24q2	
44766	44767	44768	44769	E-16B13/025/X..	26	G24q3	
44770	44771	44772	44773	E-24B13/025/X..	2x13	2xG24q1	
44774	44775	44776	44777	E-25B13/025/X..	2x18	2xG24q2	
S							
44778	44779	44780	44781	IN-12B13/025/X.. HF	60	E27	
44782	44783	44784	44785	E-16B13/025/X.. HF	26	G24q3	
N							
44786	44787	44788	44789	NZ-13/025/X..	13	G24q1	1,0
NE							
44790	44791	44792	44793	NK-E-13/025/X..	13	G24q1	1,0
44794	44795	44796	44797	NK-E-18/025/X..	18	G24q2	1,0

NOVINKA/NEW



Ø 300 mm

Náhradní stínítko/spare shade/запасное стекло

Kód/code/код	Typ/Type/тип	D [mm]
20081	025	300

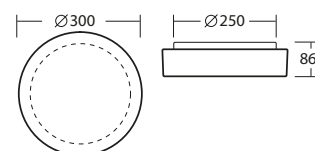

NOVINKA/NEW



Ø 325 mm

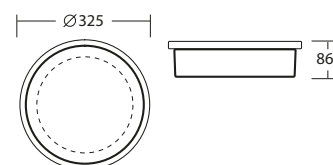

ELSA 3

NOVINKA/NEW



Ø 360 mm

Náhradní stínítko/spare shade/запасное стекло

Kód/code/код	Typ/Type/тип	D [mm]
20082	027	360

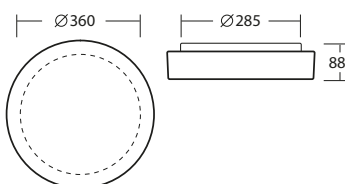

ELSA 3 IP20, IP44

Kód IP20 code IP20 код IP20	typ type тип	Kód IP44 code IP44 код IP44	typ type тип	přikon input [W]	objímka socket патрон	T [h]
A						
44798	IN-12B14/027	44814	IN-12BT14/027	100	E27	
44799	IN-22B14/027	44815	IN-22BT14/027	2x75	2xE27	
VVG						
44800	IN-16B14/027	44816	IN-16BT14/027	26	G24d3	
44801	IN-25B14/027	44817	IN-25BT14/027	2x18	2xG24d2	
EVG						
44802	E-16B14/027	44818	E-16BT14/027	26	G24q3	
44803	E-25B14/027	44819	E-25BT14/027	2x18	2xG24q2	
44804	E-26B14/027	44820	E-26BT14/027	2x26	2xG24q3	
DIM						
44805	ES-25B14/027 1-10V	44821	ES-25BT14/027 1-10V	2x18	2xG24q2	
44806	ES-25B14/027 DALI	44822	ES-25BT14/027 DALI	2x18	2xG24q2	
S						
44807	IN-12B14/027 HF	44823	IN-12BT14/027 HF	75	E27	
44808	E-16B14/027 HF	44824	E-16BT14/027 HF	26	G24q3	
N						
44809	NZ-18/027	44825	NZ-18/T/027	18	G24q2	1,0
NE						
44810	NK-E-26/027	44826	NK-E-26/T/027	26	G24q3	1,0
44811	NKC-218/13/027	44827	NKC-218/13/T/027	2x18	2xG24q2	1,0
44812	NKC-226/13/027	44828	NKC-226/13/T/027	2x26	2xG24q3	1,0
NES						
44813	NK-E-26/027 HF	44829	NK-E-26/T/027 HF	26	G24q3	1,0

LED IP44

Kód code код	kód code код	typ type тип	[lm] 3000K	[lm] 4000K	přikon input [W]	T [h]	záruka Guarantee [years]
49283	49783	LED-1L14A07BT14/027.000	1970	1970	21		3
49284	49784	LED-4L02A10BT14/027.000	2460	2630	30		5*
DIM							
49285	49785	LED-4L02A10BT14/027 1-10V.000	2460	2630	30		5
49286	49786	LED-4L02A10BT14/027 DALI.000	2460	2630	30		5
S							
49287	49787	LED-1L14A07BT14/027 HF.000	1970	1970	21		3
49288	49788	LED-4L02A10BT14/027 HF.000	2460	2630	30		5*
NE							
49289	49789	LED-1L14A07BT14/027/NK1W.000	1970	1970	21	3,0	3
49290	49790	LED-4L02A10BT14/027/NK1W.000	2460	2630	30	3,0	5*
NES							
49291	49791	LED-1L14A07BT14/027/NK1W HF.000	1970	1970	21	3,0	3
49292	49792	2ED-4L02A10BT14/027/NK1W HF.000	2460	2630	30	3,0	5*

NOVINKA/NEW



Ø 385 mm

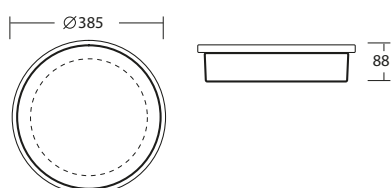

ELSA D3 IP20

kód/X4 code/X4 код/X4	kód/X11 code/X11 код/X11	kód/X12 code/X12 код/X12	kód/X13 code/X13 код/X13	typ type тип	přikon input [W]	objímka socket патрон	T [h]
A							
44830	44831	44832	44833	IN-12B14/027/X..	100	E27	
44834	44835	44836	44837	IN-22B14/027/X..	2x75	2xE27	
EVG							
44838	44839	44840	44841	E-16B14/027/X..	26	G24q3	
44842	44843	44844	44845	E-25B14/027/X..	2x18	2xG24q2	
44846	44847	44848	44849	E-26B14/027/X..	2x26	2xG24q3	
DIM							
44850	44851	44852	44853	ES-25B14/027/X.. 1-10V	2x18	2xG24q2	
44854	44855	44856	44857	ES-25B14/027/X.. DALI	2x18	2xG24q2	
S							
44858	44859	44860	44861	IN-12B14/027/X.. HF	75	E27	
44862	44863	44864	44865	E-16B14/027/X.. HF	26	G24q3	
N							
44866	44867	44868	44869	NZ-18/027/X..	18	G24q2	1,0
NE							
44870	44871	44872	44873	NK-E-26/027/X..	26	G24q3	1,0
44874	44875	44876	44877	NKC-218/13/027/X..	2x18	2xG24q2	1,0
44878	44879	44880	44881	NKC-226/13/027/X..	2x26	2xG24q3	1,0
NES							
44882	44883	44884	44885	NK-E-26/027/X.. HF	26	G24q3	1,0

ELSA 4 IP20, IP44

Kód IP20 code IP20 код IP20	typ type тип	Kód IP44 code IP44 код IP44	typ type тип	příkon input [W]	objímka socket патрон	T [h]
A						
44886	IN-22B15/029	44900	IN-22BT15/029	2x75	2xE27	
VVG						
44887	IN-17B15/029	44901	IN-17BT15/029	36	2G10	
44888	IN-26B15/029	44902	IN-26BT15/029	2x26	2xG24d3	
EVG						
44889	E-17B15/029	44903	E-17BT15/029	36	2G10	
44890	E-26B15/029	44904	E-26BT15/029	2x26	2xG24q3	
44891	E-26B15/029 32W	44905	E-26BT15/029 32W	2x32	2xGX24q3	
44892	E-204B15/029	44906	E-204BT15/029	22+40	2x2GX13	
DIM						
44893	ES-26B15/029 1-10V	44907	ES-26BT15/029 1-10V	2x26	2xG24q3	
44894	ES-26B15/029 DALI	44908	ES-26BT15/029 DALI	2x26	2xG24q3	
S						
44895	IN-22B15/029 HF	44909	IN-22BT15/029 HF	2x60	2xE27	
44896	E-17B15/029 HF	44910	E-17BT15/029 HF	36	2G10	
NE						
44897	NK-E-36/029	44911	NK-E-36/T/029	36	2G10	1,0
44898	NKC-226/13/029	44912	NKC-226/13/T/029	2x26	2xG24q3	1,0

LED IP44

Kód code код	kód code код	typ type тип	[lm]	[lm]	příkon input [W]	T [h]	záruka Guarantee [years]
3000K	4000K		3000K	4000K			
49293	49793	LED-4L11A07BT15/029.000	2950	2950	30		3
49294	49794	LED-5L02A10BT15/029.000	3080	3280	37		5*
DIM							
49295	49795	LED-5L02A10BT15/029 1-10V.000	3080	3280	37		5
49296	49796	LED-5L02A10BT15/029 DALI.000	3080	3280	37		5
S							
49297	49797	LED-4L11A07BT15/029 HF.000	2950	2950	30		3
49298	49798	LED-5L02A10BT15/029 HF.000	3080	3280	37		5*
NE							
49299	49799	LED-4L11A07BT15/029/NK1W.000	2950	2950	30	3,0	3
49300	49800	LED-5L02A10BT15/029/NK1W.000	3080	3280	37	3,0	5*

ELSA D4 - X IP20

kód/X4 code/X4 код/X4	kód/X11 code/X11 код/X11	kód/X12 code/X12 код/X12	kód/X13 code/X13 код/X13	typ type тип	příkon input [W]	objímka socket патрон	T [h]
A							
44914	44915	44916	44917	IN-22B15/029/X..	2x75	2xE27	
EVG							
44918	44919	44920	44921	E-17B15/029/X..	36	2G10	
44922	44923	44924	44925	E-26B15/029/X..	2x26	2xG24q3	
44926	44927	44928	44929	E-26B15/029/X.. 32W	2x32	2xGX24q3	
44930	44931	44932	44933	E-204B15/029/X..	22+40	2xGX13	
DIM							
44934	44935	44936	44937	ES-26B15/029/X..1-10V	2x26	2xG24q3	
44938	44939	44940	44941	ES-26B15/029/X..DALI	2x26	2xG24q3	
S							
44942	44943	44944	44945	IN-22B15/029 HF	2x60	2xE27	
44946	44947	44948	44949	E-16B15/029 HF	26	G24q3	
NE							
44950	44951	44952	44953	NK-E-36/029	36	2G10	1,0
44954	44955	44956	44957	NKC-226/13/029	2x26	2xG24q3	1,0

NOVINKA/NEW



Ø 420 mm

Náhradní stínítko/spare shade/запасное стекло

Kód/code/код	Typ/Type/тип	D [mm]
20083	029	420

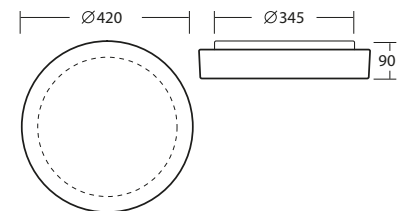

NOVINKA/NEW



Ø 445 mm

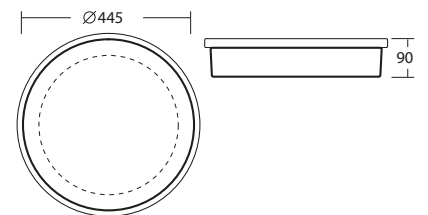

ELSA 5

NOVINKA/NEW



Ø 500 mm

Náhradní stínítko/spare shade/запасное стекло

Kód/code/код	Typ/Type/тип	D [mm]
20103	626	500

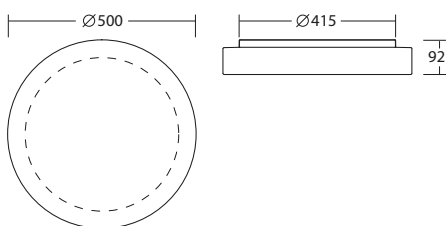

ELSA 5 IP20, IP44

Kód IP20 code IP20 код IP20	typ type тип	Kód IP44 code IP44 код IP44	typ type тип	příkon input [W]	objímka socket патрон	T [h]
-----------------------------------	--------------------	-----------------------------------	--------------------	------------------------	-----------------------------	----------

A						
54950	IN-32B16/626	54963	IN-32BT16/626	3x60	3x E27	

VVG						
54951	IN-27B16/626	54964	IN-27BT16/626	2x36	2x2G10	

EVG						
54952	E-204B16/626	54965	E-204BT16/626	22+40	2x2GX13	
54953	E-27B16/626	54966	E-27BT16/626	2x36	2x2G10	
54954	E-28B16/626	54967	E-28BT16/626	2x42	2xGX24q4	

DIM						
54955	ES-26B16/626 32W 1-10V	54968	ES-26BT16/626 32W 1-10V	2x32	2xGX24q3	
54956	ES-26B16/626 32W DALI	54969	ES-26BT16/626 32W DALI	2x32	2xGX24q3	
54957	ES-28B16/626 1-10V	54970	ES-28BT16/626 1-10V	2x42	2xGX24q4	
54958	ES-28B16/626 DALI	54971	ES-28BT16/626 DALI	2x42	2xGX24q4	

S						
54959	IN-22B16/626 HF	54972	IN-22BT16/626 HF	2x60	2xE27	
54960	E-17B16/626 HF	54973	E-17BT16/626 HF	36	2G10	

NE						
54961	NKC-226/13/626	54974	NKC-226/13/T/626	2x26	2xG24q3	1,0
54962	NKC-232/16/626	54975	NKC-232/16/T/626	2x32	2xGX24q3	1,0

LED IP44

Kód code код	kód code код	typ type тип	[lm] 3000K	[lm] 4000K	příkon input [W]	T [h]	záruka Guarantee [years]
49175	49675	LED-4L11A07BT16/626 .000	2950	2950	30		3
49176	49676	LED-6L02A10BT16/626 .000	3700	3940	43		5*

DIM							
49177	49677	LED-6L02A10BT16/626 1-10V .000	3700	3940	43		5
49178	49678	LED-6L02A10BT16/626 DALI .000	3700	3940	43		5

S							
49179	49679	LED-4L11A07BT16/626 HF .000	2950	2950	30		3
49180	49680	LED-6L02A10BT16/626 HF .000	3700	3940	43		5*

NE							
49181	49681	LED-4L11A07BT16/626/NK1W .000	2950	2950	30	3,0	3
49182	49682	LED-6L02A10BT16/626/NK1W .000	3700	3940	43	3,0	5*

ELSA 6 IP20, IP44

Kód IP20 code IP20 код IP20	typ type тип	Kód IP44 code IP44 код IP44	typ type тип	přikon input [W]	objímka socket патрон	T [h]
A						
54976	IN-32B17/627	54987	IN-32BT17/627	3x75	3xE27	
VVG						
54977	IN-46B17/627	54988	IN-46BT17/627	4x26	4xG24d3	
EVG						
54978	E-28B17/627	54989	E-28BT17/627	2x42	2xGX24q4	
54979	E-46B17/627	54990	E-46BT17/627	4x26	4xG24q3	
54980	E-46B17/627 32W	54991	E-46BT17/627 32W	4x32	4xGX24q3	
DIM						
54981	ES-46B17/627 1-10V	54992	ES-46BT17/627 1-10V	4x26	4xG24q3	
54982	ES-46B17/627 DALI	54993	ES-46BT17/627 DALI	4x26	4xG24q3	
S						
54983	IN-32B17/627 HF	54994	IN-32BT17/627 HF	3x60	3xE27	
54984	E-17B17/627 HF	54995	E-17BT17/627 HF	36	2G10	
NE						
54985	NKC-232/16/627	54996	NKC-232/T/16/627	2x32	2xGX24q3	1,0
54986	NKC-242/16/627	54997	NKC-242/T/16/627	2x42	2xGX24q4	1,0

LED IP44

Kód code код	kód code код	typ type тип	[lm]	[lm]	přikon input [W]	T [h]	záruka Guarantee [years]
3000K	4000K		3000K	4000K			
49183	49683	LED-4L12A07BT17/627 .000	3940	3940	41		3
49184	49684	LED-8L02A10BT17/627 .000	4930	5250	58		5*
DIM							
49185	49685	LED-8L02A10BT17/627 1-10V .000	4930	5250	58		5
49186	49686	LED-8L02A10BT17/627 DALI .000	3930	5250	58		5
S							
49187	49687	LED-4L12A07BT17/627 HF .000	3940	3940	41		3
49188	49688	LED-8L02A10BT17/627 HF .000	4930	5250	58		5*
NE							
49189	49689	LED-4L12A07BT17/627/NK1W .000	3940	3940	41	3,0	3
49190	49690	LED-8L02A10BT17/627/NK1W .000	4930	5250	58	3,0	5*

NOVINKA/NEW



Ø 590 mm

Náhradní stínítko/spare shade/запасное стекло

Kód/code/код	Typ/Type/тип	D [mm]
20104	627	590

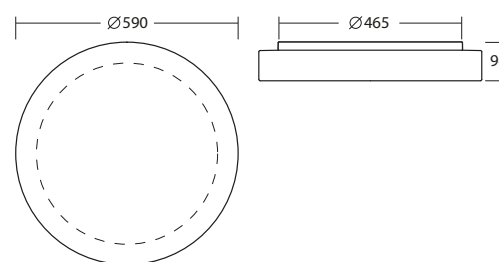

EDNA 1,2,3,4,5

LINA 1,2,3,6,7

4,5



POPIS SVÍTIDEL

Svítidla tvoří montura z kovu nebo plastu a skleněné stínítko
 Držení stínítka - sklapovací držáky
 Montáž - na stěnu nebo na strop

DESCRIPTION OF THE LIGHTING FITTINGS

The lighting fittings consist of the metal or plastic fixture and the glass shade
 Shade attachment - with folding two-step clamp holders
 Assembly - to the ceiling or on the wall

ОПИСАНИЕ СВЕТИЛЬНИКОВ

Светильники состоят из основания (металл или пластик) и стеклянного светорассеивателя
 Крепление рассеивателя - фиксаторы - защелки
 Установка - на стену, на потолок

BESCHREIBUNG DER LEUCHTEN







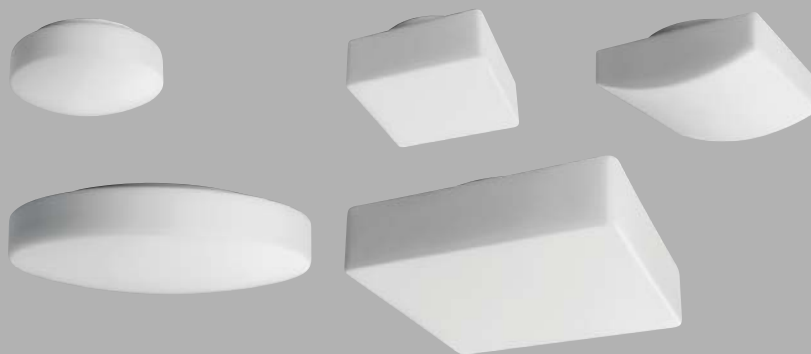



Die Leuchten bestehen aus einer Stahlblech- oder Kunststoffarmatur und einer Glasabdeckung.
 Halterung der Abdeckscheibe - klappbare Halterungen
 Montage - als Wand- oder Deckenleuchten

DESCRIPTION DES LUMINAIRES

Les luminaires d'intérieur se composent d'une monture métallique ou en plastique et d'un abat-jour en verre
 Fixation de l'abat-jour - supports clip à deux positions
 Montage - sur un plafond ou sur un mur



EDNA 1 IP43

Kód code код	typ type тип	Zdroj source лампа	přikon input [W]	objímka socket патрон	T [h]
A					
41166	IN-12K2/020		60	E27	
VVG					
41169	IN-14K2/020		13	G24d1	
EVG					
41170	E-14K2/020		13	G24q1	
N					
41180	NZ-7/020		7	2G7	1,0
A 					
41176	IN-12DU2/020		60	E27	
EVG 					
41179	E-13DU2/020		9	2G7	
N 					
41182	NZ-7/DU/020		7	2G7	1,0

LED IP43

Kód code код	kód code код	typ type тип	[lm] 3000K	[lm] 4000K	přikon input [W]	T [h]	záruka Guarantee [years]
48482	48982	LED-1L11A07K2/020.000	740	740	9		3
48483	48983	LED-2L02A07K2/020.000	920	990	11		5
N							
	47154	LED-NZ1W/020 4000		100	1	1,0	3



Ø 220 mm

Náhradní stínítko/spare shade/запасное стекло

Kód/code/код	Typ/Type/тип	D [mm]
20009	020	220

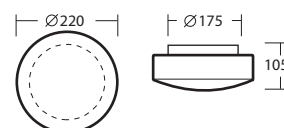

EDNA 2



Ø 280 mm

Náhradní stínítko/spare shade/запасное стекло

Kód/code/код	Typ/Type/тип	D [mm]
20010	022	280

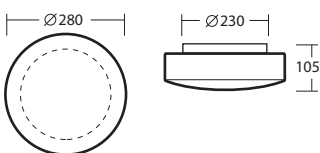

EDNA 2 IP43

Kód code код	typ type тип	Zdroj source лампа	příkon input [W]	objímka socket патрон	T [h]
A					
41183	IN-12K52/022		100	E27	
41184	IN-22K52/022		2x60	2xE27	
VVG					
41188	IN-15K52/022		18	G24d2	
41189	IN-16K52/022		26	G24d3	
41190	IN-24K52/022		2x13	2xG24d1	
EVG					
41193	E-15K52/022		18	G24q2	
41194	E-16K52/022		26	G24q3	
41195	E-24K52/022		2x13	2xG24q1	
S					
46108	IN-12K52/022 HF		60	E27	
46148	E-16K52/022 HF		26	G24q3	
N					
41215	NZ-13/022		13	G24q1	1,0
NE					
41228	NK-E-13/022		13	G24q1	1,0
44165	NK-E-18/022		18	G24q2	1,0
A □					
41208	IN-12DU52/022		100	E27	
EVG □					
41212	E-14DU52/022		13	G24q1	
N □					
41217	NZ-13/DU/022		13	G24q1	1,0

LED IP43

Kód code код	kód code код	typ type тип	[lm]		příkon input [W]	T [h]	záruka Guarantee [years]
			3000K	4000K			
48484	48984	LED-1L12A07K53/022.000	980	980	11		3
48485	48985	LED-3L02A07K53/022.000	1380	1470	15		5*
48486	48986	LED-3L02A10K53/022.000	1850	1970	23		5*
DIM							
48487	48987	LED-3L02A10K53/022 1-10 V.000	1850	1970	23		5
48488	48988	LED-3L02A10K53/022 DALI.000	1850	1970	23		5
S							
48489	48989	LED-1L12A07K53/022 HF.000	980	980	11		3
48490	48990	LED-3L02A10K53/022 HF.000	1850	1970	23		5
NE							
48491	48991	LED-1L12A07K53/022/NK1W.000	980	980	11	3,0	3
48492	48992	LED-3L02A07K53/022/NK1W.000	1380	1470	15	3,0	5

EDNA 3 IP43					
Kód code код	typ type тип	Zdroj source лампа	přikon input [W]	objímka socket патрон	T [h]
A					
43050	IN-12K63/024		100	E27	
41221	IN-22K63/024		2x75	2xE27	
VVG					
42530	IN-16K63/024		26	G24d3	
41223	IN-25K63/024		2x18	2xG24d2	
EVG					
42531	E-16K63/024		26	G24q3	
41225	E-25K63/024		2x18	2xG24q2	
DIM					
42557	ES-25K63/024 1-10V		2x18	2xG24q2	
42559	ES-25K63/024 DALI		2x18	2xG24q2	
S					
46110	IN-12K63/024 HF		75	E27	
46190	E-16K63/024 HF		26	G24q3	
N					
41237	NZ-18/024		18	G24q2	1,0
NE					
41247	NK-E-26/024		26	G24q3	1,0
NES					
44166	NK-E-26/024 HF		26	G24q3	1,0
A					
41232	IN-22DU63/024		2x60	2xE27	
EVG					
41235	E-16DU63/024		26	G24q3	
NE					
41250	NK-E-13/DU/024		13	G24q1	1,0

LED IP43							
Kód code код	kód code код	typ type тип	[lm] 3000K	[lm] 4000K	přikon input [W]	T [h]	záruka Guarantee [years]
49040	49540	LED-1L13A07K64/024.000	1480	1480	16		3
49041	49541	LED-4L02A07K64/024.000	1840	1970	20		5*
49042	49542	LED-4L02A10K64/024.000	2460	2630	30		5*
DIM							
49043	49543	LED-4L02A10K64/024 1-10V.000	2460	2630	30		5
49044	49544	LED-4L02A10K64/024 DALI.000	2460	2630	30		5
S							
49045	49545	LED-1L13A07K64/024 HF.000	1480	1480	16		3
49046	49546	LED-4L02A10K64/024 HF.000	2460	2630	30		5*
NE							
49047	49547	LED-1L13A07K64/024/NK1W.000	1480	1480	16	3,0	3
49048	49548	LED-4L02A10K64/024/NK1W.000	2460	2630	30	3,0	5
NES							
49049	49549	LED-1L13A07K64/024/NK1W HF.000	1480	1480	16	3,0	3
49050	49550	LED-4L02A10K64/024/NK1W HF.000	2460	2630	30	3,0	5



Ø 350 mm

Náhradní stínítko/spare shade/запасное стекло

Kód/code/код	Typ/Type/тип	D [mm]
20011	024	350

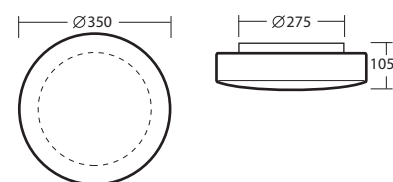

EDNA 4



Ø 420mm

Náhradní stínítko/spare shade/запасное стекло

Kód/code/код	Typ/Type/тип	D [mm]
20054	026	420

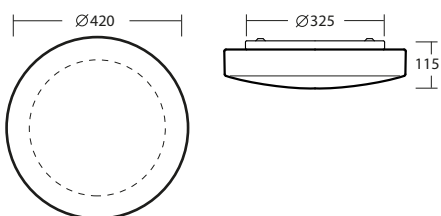

EDNA 4 IP43

Kód code код	typ type тип	Zdroj source лампа	příkon input [W]	objímka socket патрон	T [h]
A					
43030	IN-22K74/026		2x75	2x E27	
VVG					
43031	IN-17K74/026		36	2G10	
43032	IN-26K74/026		2x26	2xG24d3	
EVG					
43033	E-17K74/026		36	2G10	
43034	E-26K74/026		2x26	2xG24q3	
43035	E-26K74/026 32W		2x32	2xGX24q3	
DIM					
43036	ES-26K74/026 1-10V		2x26	2xG24q3	
43038	ES-26K74/026 DALI		2x26	2xG24q3	
S					
43039	IN-22K74/026 HF		2x60	2xE27	
43040	E-17K74/026 HF		36	2G10	
NE					
43045	NK-E-36/026		36	2G10	1,0
43046	NKC-226/13/026		2x26	2xG24q3	1,0

LED IP43

Kód code код	kód code код	typ type тип	[lm] 3000K	[lm] 4000K	příkon input [W]	T [h]	záruka Guarantee [years]
49051	49551	LED-1L14A07K75/026 .000	1970	1970	21		3
49052	49552	LED-5L02A10K75/026 .000	3080	3280	37		5*
DIM							
49053	49553	LED-5L02A10K75/026 1-10V .000	3080	3280	37		5
49054	49554	LED-5L02A10K75/026 DALI .000	3080	3280	37		5
S							
49055	49555	LED-1L14A07K75/026 HF .000	1970	1970	21		3
49056	49556	LED-5L02A10K75/026 HF .000	3080	3280	37		5*
NE							
49057	49557	LED-1L14A07K75/026/NK1W .000	1970	1970	21	3,0	3
49058	49558	LED-5L02A10K75/026/NK1W .000	3080	3280	37	3,0	5*

EDNA 5 IP43

Kód code код	typ type тип	Zdroj source лампа	přikon input [W]	objímka socket патрон	T [h]
--------------------	--------------------	--------------------------	------------------------	-----------------------------	----------



A

43051	IN-32K88/028		3x60	3x E27	
-------	--------------	---	------	--------	--





VVG

43052	IN-27K88/028		2x36	2x2G10	
-------	--------------	---	------	--------	--



EVG

43053	E-204K88/028		22+40	2x2GX13	
43054	E-27K88/028		2x36	2x2G10	
43055	E-28K88/028		2x42	2xGX24q4	



DIM

44167	ES-26K88/028 32W 1-10V		2x32	2xGX24q3	
44168	ES-26K88/028 32W DALI		2x32	2xGX24q3	
44169	ES-28K88/028 1-10V		2x42	2xGX24q4	
44170	ES-28K88/028 DALI		2x42	2xGX24q4	

S

43058	IN-22K88/028 HF		2x60	2x E27	
43059	E-17K88/028 HF		36	2G10	

NE

43061	NK-E-36/028		36	2G10	1,0
43062	NKC-226/13/028		2x26	2xG24q3	1,0
43063	NKC-232/16/028		2x32	2xGX24q3	1,0

LED IP43

Kód code код	kód code код	typ type тип	[lm] 3000K	[lm] 4000K	přikon input [W]	T [h]	záruka Guarantee [years]
49059	49559	LED-4L11A07K88/028 .000	2950	2950	30		3
49060	49560	LED-6L02A10K88/028 .000	3700	3940	43		5*

DIM

49061	49561	LED-6L02A10K88/028 1-10V .000	3700	3940	43		5
49062	49562	LED-6L02A10K88/028 DALI .000	3700	3940	43		5

S

49063	49563	LED-4L11A07K88/028 HF .000	2950	2950	30		3
49064	49564	LED-6L02A10K88/028 HF .000	3700	3940	43		5*

NE

49065	49565	LED-4L11A07K88/028/NK1W .000	2950	2950	30	3,0	3
49066	49566	LED-6L02A10K88/028/NK1W .000	3700	3940	43	3,0	5*



Ø 490 mm

Náhradní stínítko/spare shade/запасное стекло

Kód/code/код	Typ/Type/тип	D [mm]
20070	028	490

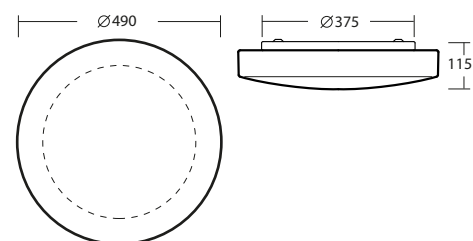

LINA 1



200x200 mm

Náhradní stínítko/spare shade/запасное стекло

Kód/code/код	Typ/Type/тип	axb [mm]
20012	033	200x200

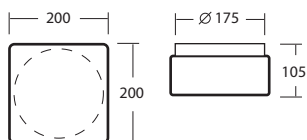

LINA 1 IP43

Kód code код	typ type тип	Zdroj source лампа	příkon input [W]	objímka socket патрон	T [h]
A					
41252	IN-12K2/033		60	E27	
VVG					
41255	IN-14K2/033		13	G24d1	
EVG					
41256	E-14K2/033		13	G24q1	
N					
41266	NZ-7/033		7	2G7	1,0
A					
41262	IN-12DU2/033		60	E27	
EVG					
41265	E-13DU2/033		9	2G7	
N					
41168	NZ-7/DU/033		7	2G7	1,0

LED IP43

Kód code код	kód code код	typ type тип	[lm]		příkon input [W]	T [h]	záruka Guarantee [years]
			3000K	4000K			
49067	49567	LED-1L11A07K2/033.000	740	740	9		3
49068	49568	LED-2L02A07K2/033.000	920	990	11		5
N							
	47166	LED-NZ1W/033 4000		100	1	1,0	3

LINA 2 IP43

Kód code код	typ type тип	Zdroj source лампа	přikon input [W]	objímka socket патрон	T [h]
A					
41269	IN-12K53/035		100	E27	
41270	IN-22K53/035		2x60	2xE27	
VVG					
41274	IN-15K53/035		18	G24d2	
41275	IN-16K53/035		26	G24d3	
41276	IN-24K53/035		2x13	2xG24d1	
EVG					
41279	E-15K53/035		18	G24q2	
41280	E-16K53/035		26	G24q3	
41281	E-24K53/035		2x13	2xG24q1	
S					
46112	IN-12K53/035 HF		60	E27	
46153	E-16K53/035 HF		26	G24q3	
N					
41301	NZ-13/035		13	G24q1	1,0
NE					
41304	NK-E-13/035		13	G24q1	1,0
44171	NK-E-18/035		18	G24q2	1,0
A					
41294	IN-12DU53/035		100	E27	
EVG					
41298	E-14DU53/035		13	G24q1	
N					
41303	NZ-13/DU/035		13	G24q1	1,0

LED IP43

Kód code код	kód code код	typ type тип	[lm] 3000K	[lm] 4000K	přikon input [W]	T [h]	záruka Guarantee [years]
49069	49569	LED-1L12A07K53/035.000	980	980	11		3
49070	49570	LED-3L02A07K53/035.000	1380	1470	15		5*
49071	49571	LED-3L02A10K53/035.000	1850	1970	23		5*
DIM							
49072	49572	LED-3L02A10K53/035 1-10V.000	1850	1970	23		5
49073	49573	LED-3L02A10K53/035 DALI.000	1850	1970	23		5
S							
49074	49574	LED-1L12A07K53/035 HF.000	980	980	11		3
49075	49575	LED-3L02A10K53/035 HF.000	1850	1970	23		5
NE							
49076	49576	LED-1L12A07K53/035/NK1W.000	980	980	11	3,0	3
49077	49577	LED-3L02A07K53/035/NK1W.000	1380	1470	15	3,0	5



260x260 mm

Náhradní stínítko/spare shade/запасное стекло

Kód/code/код	Typ/Type/тип	axb [mm]
20013	035	260x260

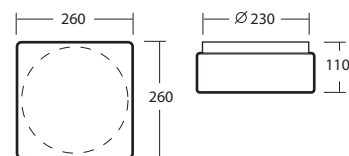

LINA 3



320x320 mm

Náhradní stínítko/spare shade/запасное стекло

Kód/code/код	Typ/Type/тип	axb [mm]
20014	037	320x320

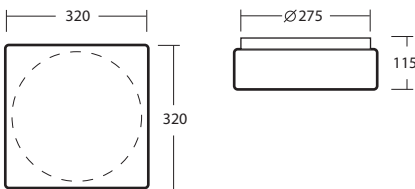













LINA 3 IP43

Kód code код	typ type тип	Zdroj source лампа	příkon input [W]	objímka socket патрон	T [h]
A					
43047	IN-12K64/037		100	E27	
41307	IN-22K64/037		2x75	2xE27	
VVG					
42532	IN-16K64/037		26	G24d3	
41309	IN-25K64/037		2x18	2xG24d2	
EVG					
42533	E-16K64/037		26	G24q3	
41311	E-25K64/037		2x18	2xG24q2	
DIM					
42563	ES-25K64/037 1-10V		2x18	2xG24q2	
42565	ES-25K64/037 DALI		2x18	2xG24q2	
S					
46114	IN-12K64/037 HF		75	E27	
46156	E-16K64/037 HF		26	G24q3	
N					
41323	NZ-18/037		18	G24q2	1,0
NE					
41333	NK-E-26/037		26	G24q3	1,0
NES					
44172	NK-E-26/037 HF		26	G24q3	1,0
A					
41318	IN-22DU64/037		2x60	2xE27	
EVG					
41321	E-16DU64/037		26	G24q3	
NE					
41336	NK-E-13/DU/037		13	G24q1	1,0

LED IP43

Kód code код	kód code код	typ type тип	[lm]		příkon input [W]	T [h]	záruka Guarantee [years]
			3000K	4000K			
49078	49578	LED-1L13A07K64/037.000	1480	1480	16		3
49079	49579	LED-4L02A07K64/037.000	1840	1970	20		5*
49080	49580	LED-4L02A10K64/037.000	2460	2630	30		5*
DIM							
49081	49581	LED-4L02A10K64/037 1-10V.000	2460	2630	30		5
49082	49582	LED-4L02A10K64/037 DALI.000	2460	2630	30		5
S							
49083	49583	LED-1L13A07K64/037 HF.000	1480	1480	16		3
49084	49584	LED-4L02A10K64/037 HF.000	2460	2630	30		5*
NE							
49085	49585	LED-1L13A07K64/037/NK1W.000	1480	1480	16	3,0	3
49086	49586	LED-4L02A10K64/037/NK1W.000	2460	2630	30	3,0	5*
NES							
49087	49587	LED-1L13A07K64/037/NK1W HF.000	1480	1480	16	3,0	3
49088	49588	LED-4L02A10K64/037/NK1W HF.000	2460	2630	30	3,0	5*

LINA 6 IP43

Kód code код	typ type тип	Zdroj source лампа	přikon input [W]	objímka socket патрон	T [h]
A					
42310	IN-22K76/039		2x75	2x E27	
VVG					
42314	IN-17K76/039		36	2G10	
42311	IN-26K76/039		2x26	2xG24d3	
EVG					
42315	E-17K76/039		36	2G10	
42312	E-26K76/039		2x26	2xG24q3	
42550	E-26K76/039 32W		2x32	2xGX24q3	
DIM					
42569	ES-26K76/039 1-10V		2x26	2xG24q3	
42570	ES-26K76/039 DALI		2x26	2xG24q3	
S					
46118	IN-22K76/039 HF		2x60	2xE27	
46162	E-17K76/039 HF		36	2G10	
NE					
42320	NK-E-36/039		36	2G10	1,0
46209	NKC-226/13/039		2x26	2xG24q3	1,0

LED IP43

Kód code код	kód code код	typ type тип	[lm] 3000K	[lm] 4000K	přikon input [W]	T [h]	záruka Guarantee [years]
DIM							
49089	49589	LED-1L14A07K76/039 .000	1970	1970	21		3
49090	49590	LED-5L02A10K76/039 .000	3080	3280	37		5*
S							
49093	49593	LED-1L14A07K76/039 HF .000	1970	1970	21		3
49094	49594	LED-5L02A10K76/039 HF .000	3080	3280	37		5*
NE							
49095	49595	LED-1L14A07K76/039/NK1W .000	1970	1970	21	3,0	3
49096	49596	LED-5L02A10K76/039/NK1W .000	3080	3280	37	3,0	5*



380x380 mm

Náhradní stínítko/spare shade/запасное стекло

Kód/code/код	Typ/Type/тип	axb [mm]
20053	039	380x380

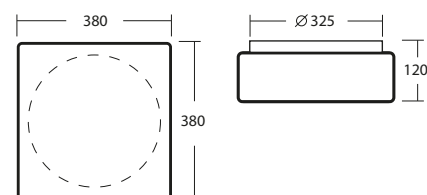

LINA 7



440x440 mm

Náhradní stínítko/spare shade/запасное стекло

Kód/code/код	Typ/Type/тип	axb [mm]
20071	139	440x440

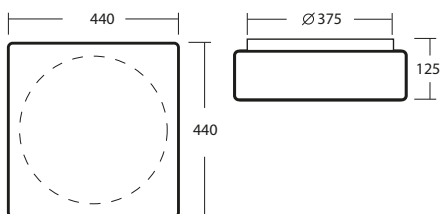

LINA 7 IP43

code	typ, type, тип	source	[W]	socket	T/[h]
A					
43070	IN-32K88/139		3x60	3x E27	
VVG					
43071	IN-27K88/139		2x36	2x2G10	
EVG					
43072	E-204K88/139		22+40	2x2GX13	
43073	E-27K88/139		2x36	2x2G10	
43074	E-28K88/139		2x42	2xGX24q4	
DIM					
44173	ES-26K88/139 32W 1-10V		2x32	2xGX24q3	
44174	ES-26K88/139 32W DALI		2x32	2xGX24q3	
44175	ES-28K88/139 1-10V		2x42	2xGX24q4	
44176	ES-28K88/139 DALI		2x42	2xGX24q4	
S					
43077	IN-22K88/139 HF		2x60	2x E27	
43078	E-17K88/139 HF		36	2G10	
NE					
43080	NK-E-36/139		36	2G10	1,0
43081	NKC-226/13/139		2x26	2xGX24q3	1,0
43082	NKC-232/16/139		2x32	2xGX24q3	1,0

LED IP43

code	code	typ, type, тип	[lm]	[lm]	[W]	T	Guarantee
3000K	4000K		3000K	4000K		[h]	years
49097	49597	LED-4L11A07K88/139.000	2950	2950	30		3
49098	49598	LED-6L02A10K88/139.000	3700	3940	43		5*
DIM							
49099	49599	LED-6L02A10K88/139 1-10V.000	3700	3940	43		5
49100	49600	LED-6L02A10K88/139 DALI.000	3700	3940	43		5
S							
49101	49601	LED-4L11A07K88/139 HF.000	2950	2950	30		3
49102	49602	LED-6L02A10K88/139 HF.000	3700	3940	43		5*
NE							
49103	49603	LED-4L11A07K88/139/NK1W.000	2950	2950	30	3,0	3
49104	49604	LED-6L02A10K88/139/NK1W.000	3700	3940	43	3,0	5*

LINA 4

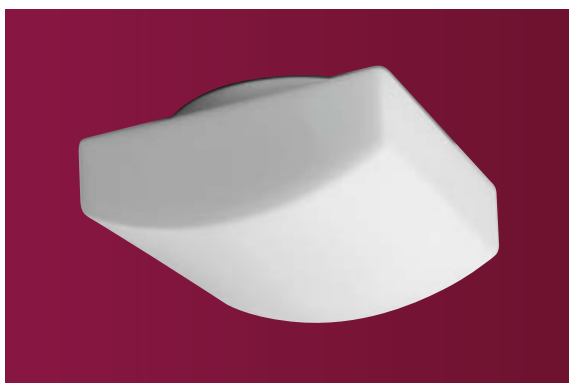

210x210 mm

Náhradní stínítko/spare shade/запасное стекло

Kód/code/код	Typ/Type/тип	axb [mm]
20015	030	210x210

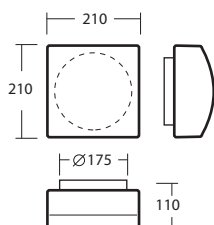

LINA 4 IP43

code	typ, type, тип	source	[W]	socket	T/[h]
A					
41338	IN-12K2/030		60	E27	
VVG					
41341	IN-14K2/030		13	G24d1	
EVG					
41342	E-14K2/030		13	G24q1	
N					
41352	NZ-7/030		7	2G7	1,0
A □					
41348	IN-12DU2/030		60	E27	
EVG □					
41351	E-13DU2/030		9	2G7	
N □					
41354	NZ-7/DU/030		7	2G7	1,0

LED IP43

code	code	typ, type, тип	[lm]	[lm]	[W]	T	Guarantee
3000K	4000K		3000K	4000K		[h]	years
49105	49605	LED-1L11A07K2/030.000	740	740	9		3
49106	49606	LED-2L02A07K2/030.000	920	990	11		5
N							
	47361	LED-NZ1W/030 4000		100	1	1,0	3

LINA 5 IP43

Kód code код	typ type тип	Zdroj source лампа	přikon input [W]	objímka socket патрон	T [h]
A					
41355	IN-12K53/031		100	E27	
41356	IN-22K53/031		2x60	2xE27	
VVG					
41360	IN-15K53/031		18	G24d2	
41361	IN-16K53/031		26	G24d3	
41362	IN-24K53/031		2x13	2xG24d1	
EVG					
41365	E-15K53/031		18	G24q2	
41366	E-16K53/031		26	G24q3	
41367	E-24K53/031		2x13	2xG24q1	
S					
46116	IN-12K53/031 HF		60	E27	
46159	E-16K53/031 HF		26	G24q3	
N					
41387	NZ-13/031		13	G24q1	1,0
NE					
41390	NK-E-13/031		13	G24q1	1,0
44174	NK-E-18/031		18	G24q2	1,0
A					
41380	IN-12DU52/031		100	E27	
EVG					
41384	E-14DU52/031		13	G24q1	
N					
41389	NZ-13/DU/031		13	G24q1	1,0

LED IP43

Kód code код	kód code код	typ type тип	[lm] 3000K	[lm] 4000K	přikon input [W]	T [h]	záruka Guarantee [years]
DIM							
49107	49607	LED-1L12A07K53/031.000	980	980	11		3
49108	49608	LED-3L02A07K53/031.000	1380	1470	15		5*
49109	49609	LED-3L02A10K53/031.000	1850	1970	23		5*
S							
49112	49612	LED-1L12A07K53/031 HF.000	980	980	11		3
49113	49613	LED-3L02A10K53/031 HF.000	1850	1970	23		5
NE							
49114	49614	LED-1L12A07K53/031/NK1W.000	980	980	11	3,0	3
49115	49615	LED-3L02A07K53/031/NK1W.000	1380	1470	15	3,0	5



260x260 mm

Náhradní stínítko/spare shade/запасное стекло

Kód/code/код	Typ/Type/тип	axb [mm]
20016	031	260x260

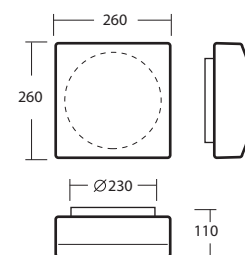

SATURN 1,2

**POPIS SVÍTIDEL**

Svítidla tvoří montura z kovu a skleněné stínítko
 Držení stínítka - sklapovací držáky
 Montáž - na stěnu nebo na strop

DESCRIPTION OF THE LIGHTING FITTINGS

The lighting fittings consist of the metal fixture and the glass shade
 Shade attachment - with folding two-step clamp holders
 Assembly - to the ceiling or on the wall

ОПИСАНИЕ СВЕТИЛЬНИКОВ

Светильники состоят из основания (металл) и стеклянного светорассеивателя
 Крепление рассеивателя - фиксаторы - защелки
 Установка - на стену, на потолок

BESCHREIBUNG DER LEUCHTEN

Die Leuchten bestehen aus einer Stahlblech armatur- und einer Glasabdeckung.
 Halterung der Abdeckscheibe - klappbare Halterungen
 Montage - als Wand- oder Deckenleuchten

DESCRIPTION DES LUMINAIRES

Tous les luminaires d'intérieur se composent d'une monture métallique et d'un abat-jour en verre.
 Fixation de l'abat-jour - supports basculants à deux positions
 Montage - sur un plafond ou sur un mur

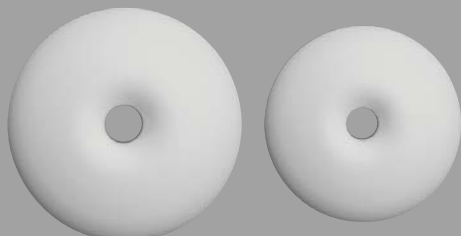
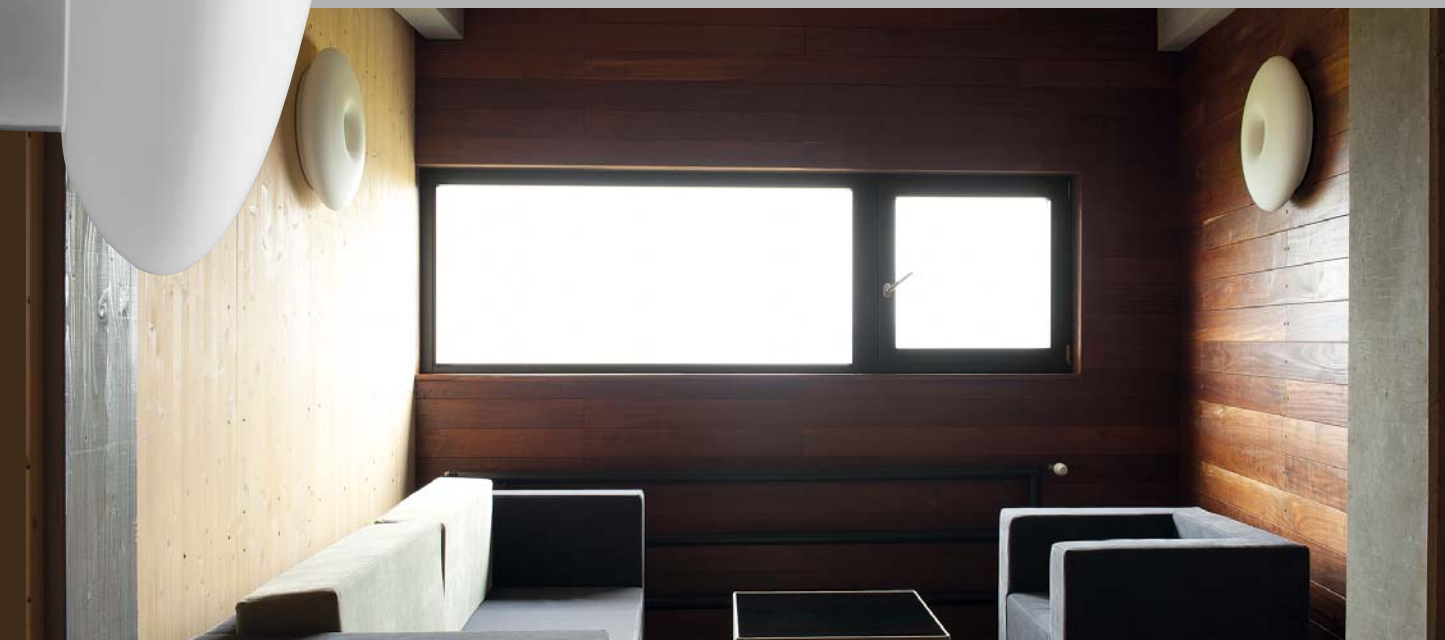

SATURN 1

SATURN 1 IP20

Kód code код	typ type тип	Zdroj source лампа	příkon input [W]	objímka socket патрон	T [h]
42222	E-101KX64/462 T5c		22	2GX13	

EVG

LED IP20

Kód code код	kód code код	typ type тип	[lm] 3000K	[lm] 4000K	příkon input [W]	T [h]	záruka Guarantee [years]
49120	49620	LED-4L02A07KX64/462.000	1840	1970	20		5
49121	49621	LED-4L02A10KX64/462.000	2460	2630	30		5



Ø 350 mm

Náhradní stínítko/spare shade/запасное стекло

Kód/code/код	Typ/Type/тип	D [mm]
20051	462	350

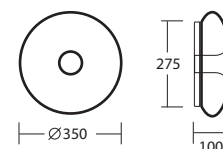

SATURN 2

SATURN 2 IP20

Kód code код	typ type тип	Zdroj source лампа	příkon input [W]	objímka socket патрон	T [h]
42223	E-102KX86/482 T5c		40	2GX13	
42224	E-204KX86/482 T5c		22+40	2x2GX13	
42623+	E-204KX86/482 T5c 2/1		22+40	2x2GX13	

DIM

42566	ES-204KX86/482 1-10V		22+40	2x2GX13	
42568	ES-204KX86/482 DALI		22+40	2x2GX13	

+ kód/code 42623 - 2/1 – dvoukruhové ovládání světelných zdrojů/ two electric circuits /двухконтурное управление лампами/Lichtquellensteuerung durch 2 Schaltkreise/Commande a 2 circuits électriques

LED IP20

Kód code код	kód code код	typ type тип	[lm] 3000K	[lm] 4000K	příkon input [W]	T [h]	záruka Guarantee [years]
49125	49625	LED-6L02A10KX86/482.000	3700	3940	43		5
DIM							
49126	49626	LED-6L02A10KX86/482 1-10V.000	3700	3940	43		5
49127	49627	LED-6L02A10KX86/482 DALI.000	3700	3940	43		5
S							
49128	49628	LED-6L02A10KX86/482 HF.000	3700	3940	43		5
NE							
49129	49629	LED-6L02A10KX86/482/NK1W.000	3700	3940	43	3,0	5



Ø 490 mm

Náhradní stínítko/spare shade/запасное стекло

Kód/code/код	Typ/Type/тип	D [mm]
20052	482	490

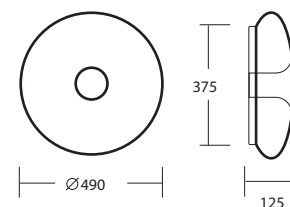

ALTAIR 1,2

**POPIS SVÍTIDEL**

Svítidla tvoří montura z kovu a skleněné stínítko
 Držení stínítka - sklapovací držáky
 Montáž - na stěnu nebo na strop

DESCRIPTION OF THE LIGHTING FITTINGS

The lighting fittings consist of the metal fixture and the glass shade
 Shade attachment - with folding two-step clamp holders
 Assembly - to the ceiling or on the wall

ОПИСАНИЕ СВЕТИЛЬНИКОВ

Светильники состоят из основания (металл) и стеклянного светорассеивателя
 Крепление рассеивателя - фиксаторы - защелки
 Установка - на стену, на потолок

BESCHREIBUNG DER LEUCHTEN

Die Leuchten bestehen aus einer Stahlblech armatur- und einer Glasabdeckung.
 Halterung der Abdeckscheibe - klappbare Halterungen
 Montage - als Wand- oder Deckenleuchten

DESCRIPTION DES LUMINAIRES

Tous les luminaires d'intérieur se composent d'une monture métallique et d'un abat-jour en verre.
 Fixation de l'abat-jour - supports basculants à deux positions
 Montage - sur un plafond ou sur un mur

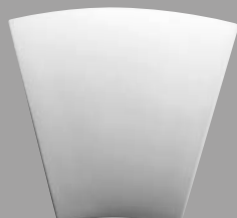

ALTAIR 1

ALTAIR 1 IP41

Kód code код	typ type тип	Zdroj source лампа	přikon input [W]	objímka socket патрон	T [h]
A					
44050	IN-12U20/420		60	E27	
44051	IN-22U20/420		2x40	2xE27	
EVG					
44052	E-25U20/420		2x18	2xG24q2	
DIM					
44053	ES-25U20/420 1-10V		2x18	2xG24q2	
44054	ES-25U20/420 DALI		2x18	2xG24q2	
S					
44055	IN-12U20/420 HF		40	E27	
NE					
44056	NKC-26/13/420		26	G24q3	1,0

LED IP41

Kód code код	kód code код	typ type тип	[lm]	[lm]	přikon input [W]	T [h]	záruka Guarantee [years]
3000K	4000K		3000K	4000K			
49130	49630	LED-6L02A07U20/420.000	2770	2950	29		5*
DIM							
49131	49631	LED-6L02A07U20/420 DALI.000	2770	2950	29		5
S							
49132	49632	LED-6L02A07U20/420 HF.000	2770	2950	29		5
NE							
49133	49633	LED-6L02A07U20/420/NK1W.000	2770	2950	29	1,0	5



350x350 mm

Náhradní stínítko/spare shade/запасное стекло

Kód/code/код	Typ/Type/тип	axb [mm]
20072	420	350x350

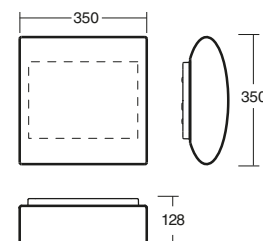

ALTAIR 2

ALTAIR 2 IP41

Kód code код	typ type тип	Zdroj source лампа	přikon input [W]	objímka socket патрон	T [h]
A					
44057	IN-12U21/421		60	E27	
44058	IN-22U21/421		2x40	2xE27	
EVG					
44059	E-25U21/421		2x18	2xG24q2	
DIM					
44060	ES-25U21/421 1-10V		2x18	2xG24q2	
44061	ES-25U21/421 DALI		2x18	2xG24q2	
S					
44062	IN-12U21/421 HF		40	E27	
NE					
44063	NKC-26/13/421		26	G24q3	1,0

LED IP41

Kód code код	kód code код	typ type тип	[lm]	[lm]	přikon input [W]	T [h]	záruka Guarantee [years]
3000K	4000K		3000K	4000K			
49134	49634	LED-5L02A07U21/421.000	2300	2460	24		5*
DIM							
49135	49635	LED-5L02A07U21/421 DALI.000	2300	2460	24		5
S							
49136	49636	LED-5L02A07U21/421 HF.000	2300	2460	24		5
NE							
49137	49637	LED-5L02A07U21/421/NK1W.000	2300	2460	24	1,0	5



360x390 mm

Náhradní stínítko/spare shade/запасное стекло

размер	Typ/Type/тип	a x b/размер [mm]
20073	421	390x360

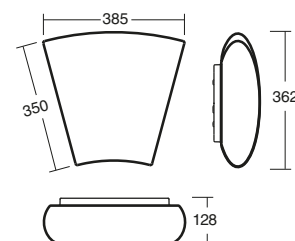



POPIS SVÍTIDEL

Svítidla **Altair 1S** a **2S** umožňují svojí konstrukcí a designem vytvářet sestavy podle individuálních požadavků.

Aby bylo docíleno co nejlepšího vzhledu sestavy a snadné montáže, je navržený tvar nejprve sestaven z pomocných montážních základů a potom osazen jednotlivými svítidly.

Svítidla **ALTAIR 1S** a **2S**, které tvoří sestavu GALAXIA mají odlišnou konstrukci od běžných samostatně montovaných svítidel

ALTAIR

Montáž sestavy	- na strop i na stěnu
Propojení sestavy	- spojovacími kabely bočními průchody
Grafický návrh sestavy	- lze sestavit konfiguratorem www.osmont.cz

DESCRIPTION OF THE LIGHTING FITTINGS

Lighting fittings **Altair 1S** and **2S** enables with its construction and design to compose the sets according to the individual requirements.

For the best design of the set and easy assembly is the suggested shape at first built up from the subsidiary assembling bases and then it is fitted with the lighting fittings.

The lighting **ALTAIR 1S** and **2S**, which create the GALAXIA set, differ with its construction from the common separately assembled lighting **ALTAIR**

ASSEMBLY OF THE SET	- to the ceiling or on the wall
Interconnection of the set	- by the connecting cables through side corridors
Graphic design of the set	- you can form it by configurator www.osmont.cz

ОПИСАНИЕ СВЕТИЛЬНИКОВ

Светильники **Altair 1S** и **2S** благодаря своей конструкции и дизайну позволяют составлять композиции в соответствии с индивидуальными предпочтениями

С целью создания наилучших композиций и достижения простоты установки, планируемая форма в первую очередь составляется из вспомогательных монтажных оснований, после чего комплектуется отдельными светильниками.

Светильники **ALTAIR 1S** и **2S** предназначенные для включения в состав композиций, отличаются по конструкции от обыкновенных, устанавливаемых по отдельности светильников

Установка набора	- настенный/потолочный
Подключение набора	- соединительными кабелями через боковые каналы
Графический расчет проекта	- можно осуществить с помощью конфигуратора www.osmont.cz

BESCHREIBUNG DER LEUCHTEN

Die Konstruktion und das Design der Leuchten **Altair 1S** und **2S** machen die Zusammenstellung von Leuchten – Sets nach individuellen Anforderungen möglich.

Um die bestmögliche Gestaltung und eine einfache Montage des Sets zu erzielen, wird die vorgeschlagene Form zuerst aus Hilfsgrundplatten zusammengestellt und dann mit einzelnen Leuchten bestückt.

Die Konstruktion der Leuchten **ALTAIR 1S** und **2S**, die das Set GALAXIA bilden, unterscheidet sich von den üblichen, eigenständig montierten Leuchten **ALTAIR**.

Montage des Sets	- als Decken- oder Wandleuchte
Verbindung des Sets	- durch Verbindungskabel in seitlichen Durchgangsöffnungen
Der grafische Set- Entwurf	- kann mit dem Konfigurator unter www.osmont.cz erstellt werden

DESCRIPTION DES LUMINAIRES AVEC COL DÉCORATIF

Les luminaires **Altair 1S** et **2S** permettent, par leur construction et leur conception, de créer des combinaisons selon les exigences individuelles.

Pour obtenir le meilleur aspect possible et pour un montage plus facile, il est proposé tout d'abord une combinaison à l'aide d'un kits de montage et ensuite de luminaires individuels.

Les luminaires **ALTAIR 1S** et **2S**, qui forment l'ensemble GALAXIA ont une construction différente des luminaires **ALTAIR** montés séparément.

Kit de montage	- sur le plafond ou sur un mur
Connexion des combinaisons	- connexion des câbles sur le coté latéral
Suggestion graphique de conception	- peut être configurer sur www.osmont.cz

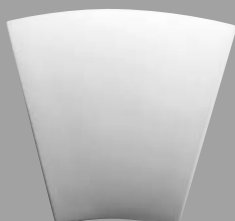
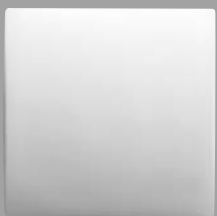

ALTAIR 1S

ALTAIR 1S IP41

Kód code код	typ type тип	Zdroj source лампа	přikon input [W]	objímka socket патрон	T [h]
--------------------	--------------------	--------------------------	------------------------	-----------------------------	----------

EVG

44080	E-25US20/420		2x18	2xG24q2	
-------	--------------	--	------	---------	--

DIM

44081	ES-25US20/420 1-10V		2x18	2xG24q2	
44082	ES-25US20/420 DALI		2x18	2xG24q2	

LED IP41

Kód code код	kód code код	typ type тип	[lm]	[lm]	přikon input [W]	T [h]	záruka Guarantee [years]
3000K	4000K		3000K	4000K			
49138	49638	LED-6L02A07US20/420.000	2770	2950	29		5*

DIM

49139	49639	LED-6L02A07US20/420 DALI.000	2770	2950	29		5
-------	-------	------------------------------	------	------	----	--	---



350x350 mm

Náhradní stínítko/spare shade/запасное стекло

Kód/code/код	Typ/Type/тип	axb [mm]
20072	420	350x350

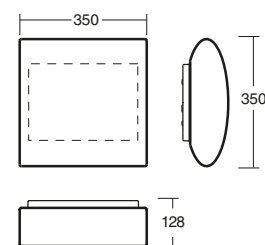

ALTAIR 2S IP41

Kód code код	typ type тип	Zdroj source лампа	přikon input [W]	objímka socket патрон	T [h]
--------------------	--------------------	--------------------------	------------------------	-----------------------------	----------

EVG

44083	E-25US21/421		2x18	2xG24q2	
-------	--------------	--	------	---------	--

DIM

44084	ES-25US21/421 1-10V		2x18	2xG24q2	
44085	ES-25US21/421 DALI		2x18	2xG24q2	

LED IP41

Kód code код	kód code код	typ type тип	[lm]	[lm]	přikon input [W]	T [h]	záruka Guarantee [years]
3000K	4000K		3000K	4000K			
49142	49642	LED-5L02A07US21/421.000	2300	2460	24		5*

DIM

49143	49643	LED-5L02A07US21/421 DALI.000	2300	2460	24		5
-------	-------	------------------------------	------	------	----	--	---

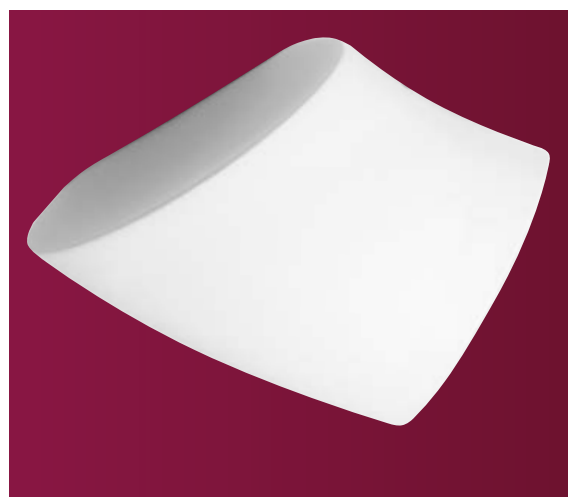

390x360 mm

Náhradní stínítko/spare shade/запасное стекло

Kód/code/код	Typ/Type/тип	axb [mm]
20073	421	390x360

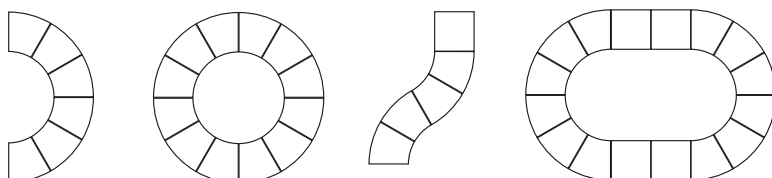
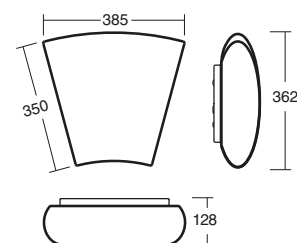

* viz str. „See, см. страница, Siehe, voir : 204

SYLVIA 1,2

**POPIS SVÍTIDEL**

Svítidla tvoří montura z kovu a skleněné stínítka
 Držení stínítka - sklapovací držáky
 Montáž - na stěnu nebo na strop

DESCRIPTION OF THE LIGHTING FITTINGS

The lighting fittings consist of the metal fixture and the glass shade
 Shade attachment - with folding two-step clamp holders
 Assembly - to the ceiling or on the wall

ОПИСАНИЕ СВЕТИЛЬНИКОВ

Светильники состоят из основания (металл) и стеклянного светорассеивателя
 Крепление рассеивателя - фиксаторы - защелки
 Установка - на стену, на потолок

BESCHREIBUNG DER LEUCHTEN

Die Leuchten bestehen aus einer Stahlblech armatur- und einer Glasabdeckung.
 Halterung der Abdeckscheibe - klappbare Halterungen
 Montage - als Wand- oder Deckenleuchten

DESCRIPTION DES LUMINAIRES

Tous les luminaires d'intérieur se composent d'une monture métallique et d'un abat-jour en verre.
 Fixation de l'abat-jour - supports basculants à deux positions
 Montage - sur un plafond ou sur un mur

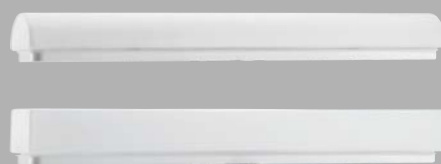



POPIS SVÍTIDEL S DEKORATIVNÍMI LÍMCI

Svítidla tvoří montura z kovu, skleněné stínítko a dekorativní kovový límeček
 Dekorativní límeček - je volně podložen pod stínítkem

DESCRIPTION OF THE LIGHTING FITTINGS WITH DECORATIVE RINGS

The lighting fittings consist of the metal fixture, the glass shade and the decorative metal ring
 Decorative ring - is freely placed under the shade

ОПИСАНИЕ СВЕТИЛЬНИКОВ

Светильники состоят из металлического основания, стеклянного светорассеивателя и декоративного металлического обода
 Декоративный обод - установлен свободно под светорассеивателем

BESCHREIBUNG DER LEUCHTEN MIT DEKORATIVEM METALLRING

Die Leuchten bestehen aus einer Stahlblecharmatur, einer Glasabdeckung und einem dekorativen Metallring
 Der dekorative Metallring - ist der Abdeckscheibe frei untergesetzt

DESCRIPTION DES LUMINAIRES AVEC COL DÉCORATIF

Tous les luminaires d'intérieur se composent d'une monture métallique, d'un abat-jour en verre et un col décoratif
 Col décoratif - est calé discrètement sous l'abat-jour



Dekorativní límeček / Decorative ring / Декоративный обод / Dekorativer Ring / col décoratif

X4 bílý lak / White paint / белый лак / Weißlack / Laqué blanc

X14 nerez leštěná / stainless steel polished / хром / Edelstahl poliert / Inox poli

X15 nerez broušená / stainless steel ground / матовый хром / Edelstahl geschliffen / Inox émolu



SYLVIA 1

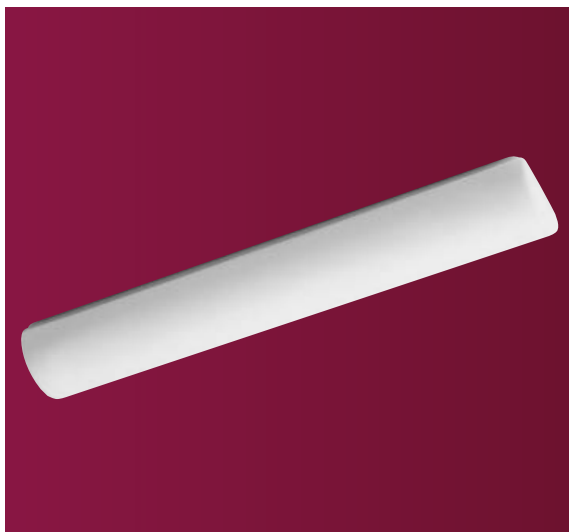

610x100 mm

Náhradní stínítko/spare shade/запасное стекло

Kód/code/код	Typ/Type/тип	axb [mm]
20074	129	610x100

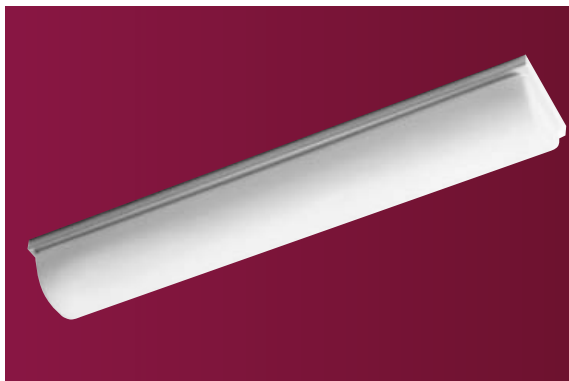
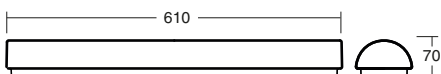

620x110 mm

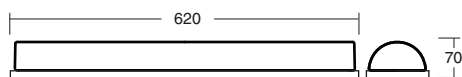

SYLVIA 1 IP44

Kód code код	typ type тип	Zdroj source лампа	příkon input [W]	objímka socket патрон	T [h]
--------------	--------------	--------------------	------------------	-----------------------	-------

A

44070	IN-32U12/129		3x28	3xE14	
-------	--------------	--	------	-------	--

EVG

44071	E-16U12/129		24	G5	
-------	-------------	--	----	----	--

LED IP44

Kód code код	kód code код	typ type тип	[lm]	[lm]	příkon input [W]	T [h]	záruka Guarantee [years]
3000K	4000K		3000K	4000K			
47396	47896	LED-L26U12/129.000	1650	1650	19		3

SYLVIA D1 IP44

kód/X4 code/X4 код/X4	kód/X14 code/X14 код/X14	kód/X15 code/X15 код/X15	typ type тип	příkon input [W]	objímka socket патрон	T [h]
-----------------------	--------------------------	--------------------------	--------------	------------------	-----------------------	-------

A

44537	44539	44541	IN-32U12/129/X..	3x28	3xE14	
-------	-------	-------	------------------	------	-------	--

EVG

44538	44540	44542	E-16U12/129/X..	24	G5	
-------	-------	-------	-----------------	----	----	--

LED IP44

kód/X4 code/X4 код/X4	kód/X14 code/X14 код/X14	kód/X15 code/X15 код/X15	typ type тип	[lm]	příkon input [W]	T [h]	záruka Guarantee [years]
-----------------------	--------------------------	--------------------------	--------------	------	------------------	-------	--------------------------



3000 K

48403	48404	48405	LED-L26U12/129/X.. 3000	1650	19		3
-------	-------	-------	-------------------------	------	----	--	---

4000 K

48903	48904	48905	LED-L26U12/129/X.. 4000	1650	19		3
-------	-------	-------	-------------------------	------	----	--	---

SYLVIA 2 IP44

Kód code код	typ type тип	Zdroj source лампа	příkon input [W]	objímka socket патрон	T [h]
A					
44072	IN-32U12/130		3x28	3xE14	
EVG					
44073	E-16U12/130		24	G5	

LED IP44 

Kód code код	kód code код	typ type тип	[lm]	[lm]	příkon input [W]	T [h]	záruka Guarantee [years]
			3000K	4000K			
47895	47395	LED-L26U12/130.000	1650	1650	19		3



610x100mm

Náhradní stínítko/spare shade/запасное стекло

Kód/code/код	Typ/Type/тип	axb [mm]
20075	130	610x100

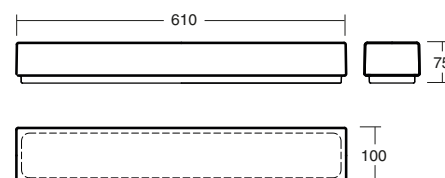

SYLVIA D2 IP44

kód/X4 code/X4 код/X4	kód/X14 code/X14 код/X14	kód/X15 code/X15 код/X15	typ type тип	příkon input [W]	objímka socket патрон	T [h]
A						
44543	44545	44547	IN-32U12/130/X..	3x28	3xE14	
EVG						
44544	44546	44548	E-16U12/130/X..	24	G5	

LED IP44 

kód/X4 code/X4 код/X4	kód/X14 code/X14 код/X14	kód/X15 code/X15 код/X15	typ type тип	[lm]	příkon input [W]	T [h]	záruka Guarantee [years]
3000 K							
48400	48401	48402	LED-L26U12/130/X.. 3000	1650	19		3
4000 K							
48900	48901	48902	LED-L26U12/130/X.. 4000	1650	19		3

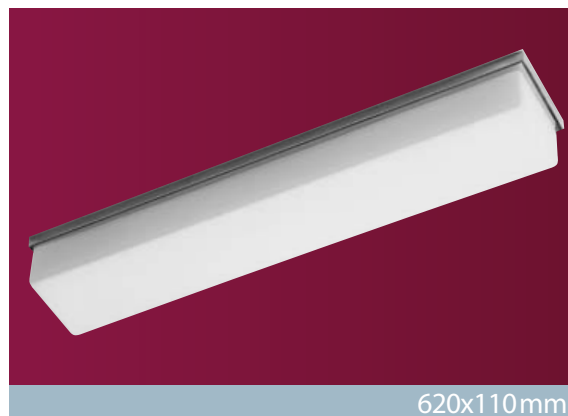

620x110mm

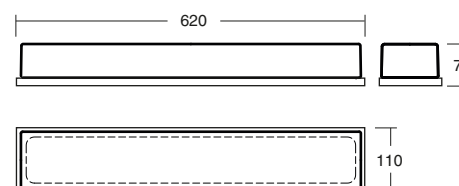

FLORA 1,2,3,4,5



POPIS SVÍTIDEL

Svítidla tvoří montura z plastu a skleněné stínítko
 Držení stínítka - sklapovací držáky
 Montáž - na stěnu

DESCRIPTION OF THE LIGHTING FITTINGS

The lighting fittings consist of the plastic fixture and the glass shade
 Shade attachment - with folding two-step clamp holders
 Assembly - on the wall

ОПИСАНИЕ СВЕТИЛЬНИКОВ

Светильники состоят из пластикового основания и стеклянного светорассеивателя
 Крепление рассеивателя - фиксаторы-защелки
 Установка - настенный

BESCHREIBUNG DER LEUCHTEN

Die Leuchten bestehen aus einer Kunststoffarmatur und einer Glasabdeckung
 Halterung der Abdeckscheibe - klappbare Halterungen
 Montage - als Wandleuchten







DESCRIPTION DES LUMINAIRES

Tous les luminaires d'intérieur se composent d'une abat-jour en verre et d'une monture plastique
 Fixation de l'abat-jour - supports basculants à deux positions
 Montage - sur un plafond



FLORA 1

FLORA 1 IP43 □

Kód code код	typ type тип	Zdroj source лампа	přikon input [W]	objímka socket патрон	T [h]
A					
41711	IN-22DU11/124		2x25	2xE14	
VVG					
41712	IN-13DU11/124		9	G23	
41713	IN-14DU11/124		13	G24d1	
EVG					
41714	E-13DU11/124		9	G27	
41715	E-14DU11/124		13	G24q1	
41716	E-15DU11/124		18	G24q2	



225x85 mm



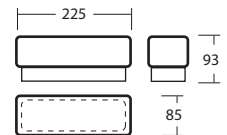

Náhradní stínítko/spare shade/запасное стекло

Kód/code/код	Typ/Type/тип	axb [mm]
20028	124	225x85



FLORA2

FLORA 2 IP43 □

Kód code код	typ type тип	Zdroj source лампа	přikon input [W]	objímka socket патрон	T [h]
A					
41717	IN-22DU12/125		2x25	2xE14	
VVG					
41718	IN-13DU12/125		11	G23	
EVG					
41719	E-13DU12/125		11	G27	
41720	E-15DU12/125		18	G24q2	



310x85 mm

Náhradní stínítko/spare shade/запасное стекло

Kód/code/код	Typ/Type/тип	axb [mm]
20029	125	310x85

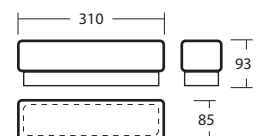

FLORA 3



225x85 mm

Náhradní stínítko/spare shade/запасное стекло

Kód/code/код	Typ/Type/тип	axb [mm]
20030	126	225x85

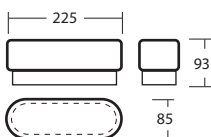

FLORA 3 IP43 □

Kód code код	typ type тип	Zdroj source лампа	příkon input [W]	objímka socket патрон	T [h]
A					
41723	IN-22DU13/126		2x25	2xE14	
VVG					
41724	IN-13DU13/126		9	G23	
41725	IN-14DU13/126		13	G24d1	
EVG					
41726	E-13DU13/126		9	2G7	
41727	E-14DU13/126		13	G24q1	
41728	E-15DU13/126		18	G24q2	

FLORA 4



280x80 mm

Náhradní stínítko/spare shade/запасное стекло



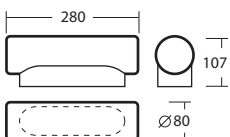



Kód/code/код	Typ/Type/тип	axb [mm]
20031	127	280x80



FLORA 4 IP43 □

Kód code код	typ type тип	Zdroj source лампа	příkon input [W]	objímka socket патрон	T [h]
A					
41729	IN-22DU14/127		2x25	2xE14	
VVG					
41730	IN-13DU14/127		9	G23	
41731	IN-14DU14/127		13	G24d1	
EVG					
41732	E-13DU14/127		9	2G7	
41733	E-14DU14/127		13	G24q1	
41734	E-15DU14/127		18	G24q2	

FLORA 5 IP43 □

Kód code код	typ type тип	Zdroj source лампа	přikon input [W]	objímka socket патрон	T [h]
A					
41735	IN-22DU14/128		2x25	2xE14	
VVG					
41736	IN-13DU14/128		9	G23	
41737	IN-14DU14/128		13	G24d1	
EVG					
41738	E-13DU14/128		9	2G7	
41739	E-14DU14/128		13	G24q1	
41740	E-15DU14/128		18	G24q2	



330x80mm

Náhradní stínítko/spare shade/запасное стекло

Kód/code/код	Typ/Type/тип	axb [mm]
20032	128	330x80

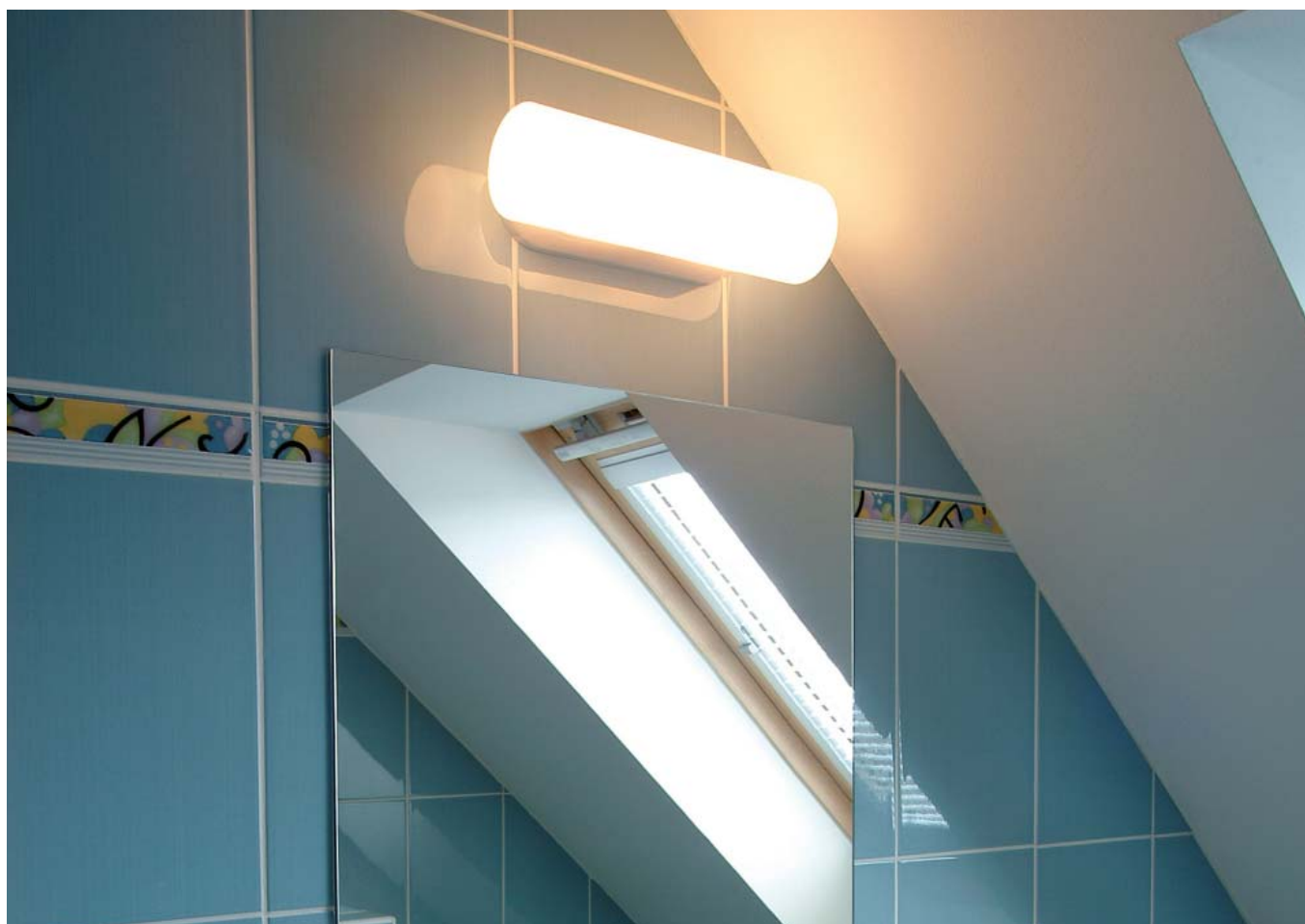
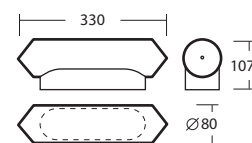

JENA 1,2

**POPIS SVÍTIDEL**

Svítidla tvoří montura z kovu a skleněné stínítko
 Držení stínítka - sklápovací držáky
 Montáž - na stěnu nebo na strop

DESCRIPTION OF THE LIGHTING FITTINGS

The lighting fittings consist of the metal fixture and the glass shade
 Shade attachment - with folding two-step clamp holders
 Assembly - to the ceiling or on the wall

ОПИСАНИЕ СВЕТИЛЬНИКОВ

Светильники состоят из металлического основания и стеклянного светорассеивателя
 Крепление рассеивателя - фиксаторы - защелки
 Установка - на стену, на потолок

BESCHREIBUNG DER LEUCHTEN

Die Leuchten bestehen aus einer Stahlblecharmatur und einer Glasabdeckung
 Halterung der Abdeckscheibe - klappbare Halterungen
 Montage - als Wand- oder Deckenleuchten

DESCRIPTION DES LUMINAIRES

Tous les luminaires d'intérieur se composent d'une monture métallique et d'un abat-jour en verre
 Fixation de l'abat-jour - supports basculants à deux positions
 Montage - sur un plafond ou sur un mur



JENA 1

JENA 1 IP43

Kód code код	typ type тип	Zdroj source лампа	příkon input [W]	objímka socket патрон	T [h]
A					
41393	IN-12U8/036		60	E27	
VVG					
41396	IN-14U8/036		13	G24d1	
EVG					
41397	E-14U8/036		13	G24q1	
N					
41398	NZ-7/036		7	2G7	1,0

LED IP43

Kód code код	kód code код	typ type тип	[lm] 3000K	[lm] 4000K	příkon input [W]	T [h]	záruka Guarantee [years]
49146	49646	LED-2L02A07U8/036.000	920	990	11		5

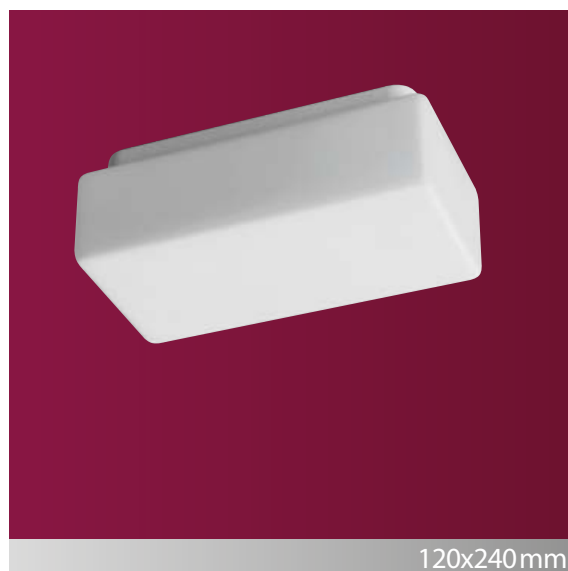





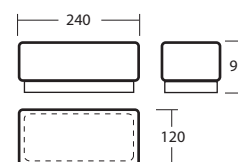







Náhradní stínítko/spare shade/запасное стекло

Kód/code/код	Typ/Type/тип	axb [mm]
20017	036	120x240



JENA 2

JENA 2 IP43

Kód code код	typ type тип	Zdroj source лампа	příkon input [W]	objímka socket патрон	T [h]
A					
41399	IN-12U9/038		100	E27	
41400	IN-22U9/038		2x60	2xE27	
VVG					
41401	IN-15U9/038		18	G24d2	
41402	IN-16U9/038		26	G24d3	
41403	IN-24U9/038		2x13	2xG24d1	
EVG					
41404	E-15U9/038		18	G24q2	
41405	E-16U9/038		26	G24q3	
41406	E-24U9/038		2x13	2xG24q1	
S					
46119	IN-12U9/038 HF		60	E27	
N					
41407	NZ-13/038		13	G24q1	1,0
NE					
41411	NK-E-18/038		18	G24q2	1,0
41412	NK-E-26/038		26	G24q3	1,0

LED IP43

Kód code код	kód code код	typ type тип	[lm] 3000K	[lm] 4000K	příkon input [W]	T [h]	záruka Guarantee [years]
49147	49647	LED-4L02A07U9/038.000	1840	1970	20		5



Náhradní stínítko/spare shade/запасное стекло

Kód/code/код	Typ/Type/тип	axb [mm]
20018	038	170x340

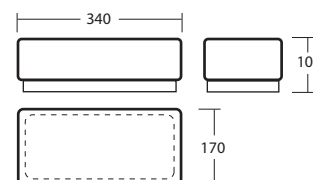

NELA 1,2,3,4A

**POPIS SVÍTIDEL**

Svítidla tvoří montura z kovu a skleněné stínítko
 Držení stínítka - šroubkové, sklápovací (NELA 4A)
 Montáž - na stěnu

DESCRIPTION OF THE LIGHTING FITTINGS

The lighting fittings consist of the metal fixture and the glass shade
 Shade attachment - with screws, with folding two-step clamp holders (NELA 4A)
 Assembly - on the wall

ОПИСАНИЕ СВЕТИЛЬНИКОВ

Светильники состоят из металлического основания и стеклянного светорассеивателя
 Крепление рассеивателя - винтовое крепление, фиксаторы - защелки (NELA 4A)
 Установка - настенный

BESCHREIBUNG DER LEUCHTEN

Die Leuchten bestehen aus einer Stahlblecharmatur und einer Glasabdeckung.
 Halterung der Abdeckscheibe - Schraubenhalterungen, klappbare Halterungen (NELA 4A)
 Montage - als Wandleuchten

DESCRIPTION DES LUMINAIRES

Tous les luminaires d'intérieur se composent d'une monture métallique et d'un abat-jour en verre
 Fixation de l'abat-jour - supports par vis, supports basculants à deux positions (NELA 4A)
 Montage - sur un mur

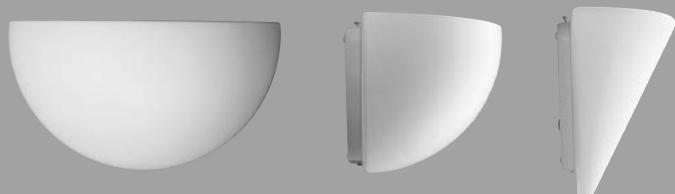
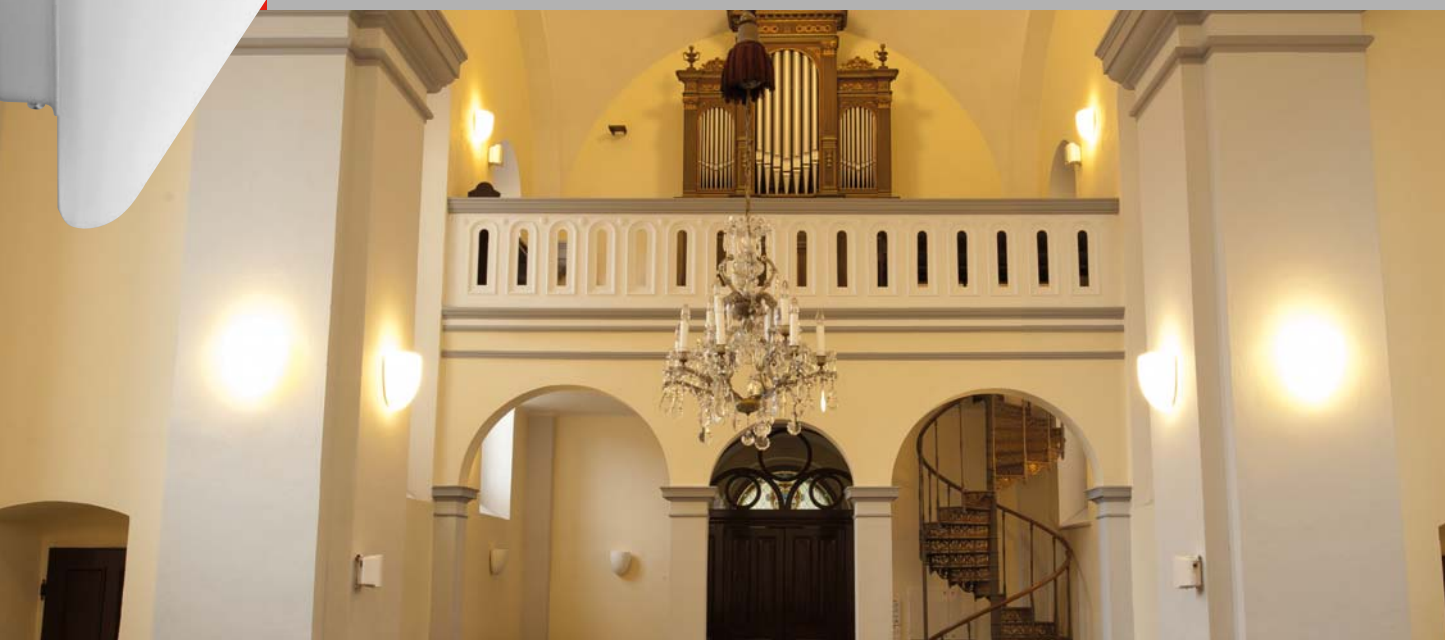
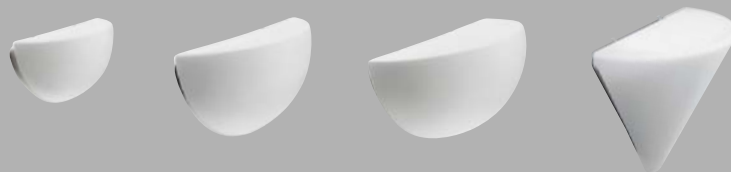

POPIS SVÍTIDEL S DEKORATIVNÍMI LÍMCI

Dekorativní límec – je součástí montury

Upozornění: veškerá svítidla s dekorativními límci lze vybavit i LED zdroj – viz NELA 1-3

DESCRIPTION OF THE LIGHTING FITTINGS WITH DECORATIVE RINGS

Decorative ring; – it is part of the fixture

Notice: It is possible to equip all the light fittings with decorative rings with LED –sources too- see Nela 1-3

ОПИСАНИЕ СВЕТИЛЬНИКОВ С ДЕКОРАТИВНЫМИ ЭЛЕМЕНТАМИ

Декоративный элемент является составной частью металлического основания

Внимание: все светильники с декоративными элементами могут быть оборудованы светодиодными модулями – см. NELA 1-3

BESCHREIBUNG DER LEUCHTEN MIT DEKORATIVEM METALLRING

Decorativer Ring; Bestandteil der Armatur

Hinweis: Sämtliche Leuchten mit dekorativen Metallringen können auch mit einer LED –Lampe ausgestattet werden – siehe Nela 1-3

DESCRIPTION DES LUMINAIRES AVEC COL DÉCORATIF

Cól décoratif; se trouve dans la monture

Remarque: Tous le luminaires avec col decorative peuvent également être équipés de LED –voir Nela 1-3

**Dekorativní límec / Decorative ring / Декоративный элемент / Dekorativer Ring / col décoratif**

DL4 bílý lak / White paint / белый лак / Weißlack / Laqué blanc

DL14 nerez leštěná / stainless steel polished / хром / Edelstahl poliert / Inox poli

DL15 nerez broušená / stainless steel ground / матовый хром / Edelstahl geschliffen / Inox émoulu



NELA 1



Ø 250 mm

Náhradní stínítko/spare shade/запасное стекло

Kód/code/код	Typ/Type/тип	D/mm
20020	244	250

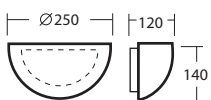

Ø 270 mm

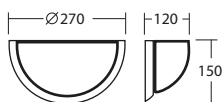

NELA 1 IP43

Kód code код	typ type тип	Zdroj source лампа	příkon input [W]	objímka socket патрон	T [h]
A					
41417	IN-12U5/244		60	E27	
VVG					
41418	IN-14U5/244		13	G24d1	
EVG					
41419	E-14U5/244		13	G24q1	
N					
41420	NZ-7/244		7	2G7	1,0











LED IP43

Kód code код	kód code код	typ type тип	[lm] 3000K	[lm] 4000K	příkon input [W]	T [h]	záruka Guarantee [years]
49149	49649	LED-2L02A07U5/244 .000	920	990	11		5

NELA DL1 IP43

kód/DL4 code/DL4 код/DL4	kód/DL14 code/DL14 код/DL14	kód/DL15 code/DL15 код/DL15	typ type тип	příkon input [W]	objímka socket патрон	T [h]
A						
44550	44554	44558	IN-12U5/244/DL..	60	E27	
EVG						
44552	44556	44560	E-14U5/244/DL..	13	G24q1	
N						
44553	44557	44561	NZ-7/244/DL..	7	2G7	1,0

NELA 2 IP43

Kód code код	typ type тип	Zdroj source лампа	příkon input [W]	objímka socket патрон	T [h]
A					
41421	IN-12U7/264		100	E27	
41422	IN-22U7/264		2x60	2xE27	
VVG					
41423	IN-15U7/264		18	G24d2	
41424	IN-16U7/264		26	G24d3	
41425	IN-24U7/264		2x13	2xG24d1	
EVG					
41426	E-15U7/264		18	G24q2	
41427	E-16U7/264		26	G24q3	
41428	E-24U7/264		2x13	2xG24q1	
S					
46120	IN-12U7/264 HF		60	E27	
N					
41429	NZ-13/264		13	G24q1	1,0
NE					
41430	NK-E-13/264		13	G24q1	1,0

LED IP43

Kód code код	kód code код	typ type тип	[lm]	[lm]	příkon input [W]	T [h]	záruka Guarantee [years]
3000K	4000K		3000K	4000K			
49150	49650	LED-4L02A07U7/264.000	1840	1970	20		5

NELA DL2 IP43

kód/DL4 code/DL4 код/DL4	kód/DL14 code/DL14 код/DL14	kód/DL15 code/DL15 код/DL15	typ type тип	příkon input [W]	objímka socket патрон	T [h]
A						
44562	44573	44584	IN-12U7/264/DL..	100	E27	
44563	44574	44585	IN-22U7/264/DL..	2x60	2xE27	
EVG						
44567	44578	44589	E-15U7/264/DL..	18	G24q2	
44568	44579	44590	E-16U7/264/DL..	26	G24q3	
S						
44570	44581	44592	IN-12U7/264/DL.. HF	60	E27	
N						
44571	44582	44593	NZ-13/264/DL..	13	G24q1	1,0
NE						
44572	44583	44594	NK-E-13/264/DL..	13	G24q1	1,0



Náhradní stínítko/spare shade/запасное стекло

Kód/code/код	Typ/Type/тип	D/mm
20021	264	350

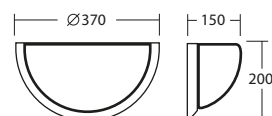
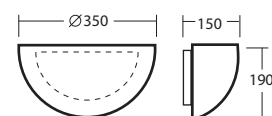

NELA 3



Ø 350 mm

Náhradní stínítko/spare shade/запасное стекло

Kód/code/код	Typ/Type/тип	D/mm
20022	268	350

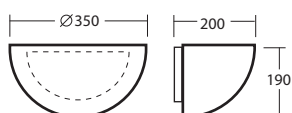

Ø 370 mm

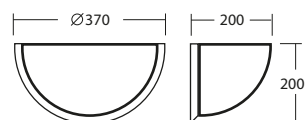

NELA 3 IP43

Kód code код	typ type тип	Zdroj source лампа	příkon input [W]	objímka socket патрон	T [h]
A					
41431	IN-22U7/268		2x60	2xE27	
VVG					
41433	IN-16U7/268		26	G24d3	
41434	IN-25U7/268		2x18	2xG24d2	
EVG					
41436	E-16U7/268		26	G24q3	
41437	E-25U7/268		2x18	2xG24q2	
S					
46121	IN-12U7/268 HF		60	E27	
N					
41438	NZ-18/268		18	G24q2	1,0
NE					
41442	NK-E-26/268		26	G24q3	1,0







LED IP43

Kód code код	kód code код	typ type тип	[lm]	[lm]	příkon input [W]	T [h]	záruka Guarantee [years]
3000K	4000K		3000K	4000K			
49151	49651	LED-4L02A07U7/268.000	1840	1970	20		5

NELA DL3 IP43

kód/DL4 code/DL4 код/DL4	kód/DL14 code/DL14 код/DL14	kód/DL15 code/DL15 код/DL15	typ type тип	příkon input [W]	objímka socket патрон	T [h]
A						
44595	44608	44621	IN-22U7/268/DL..	2x60	2xE27	
EVG						
44600	44613	44626	E-16U7/268/DL..	26	G24q3	
44601	44614	44627	E-25U7/268/DL..	2x18	2xG24q2	
S						
44602	44615	44628	IN-12U7/268/DL.. HF	60	E27	
N						
44603	44616	44629	NZ-18/268/DL..	18	G24q2	1,0
NE						
44607	44620	44633	NK-E-26/268/DL..	26	G24q3	1,0

NELA 4A IP43

Kód code код	typ type тип	Zdroj source лампа	přikon input [W]	objímka socket патрон	T [h]
A					
43084	IN-12U31/322		100	E27	
VVG					
43085	IN-15U31/322		18	G24d2	
43086	IN-16U31/322		26	G24d3	
EVG					
43087	E-15U31/322		18	G24q2	
43088	E-16U31/322		26	G24q3	
N					
43089	NZ-7/322		7	2G7	1,0

LED IP43

Kód code код	kód code код	typ type тип	[lm]	[lm]	přikon input [W]	T [h]	záruka Guarantee [years]
	3000K	4000K	3000K	4000K			
49152	49652	LED-3L02A07U31/322.000	1380	1470	15		5



Ø 300 mm

Náhradní stínítko/spare shade/запасное стекло

Kód/code/код	Typ/Type/тип	D/mm
20084	322	300

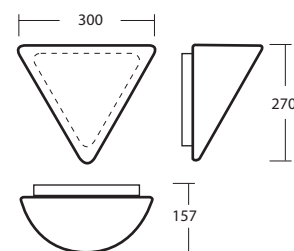

LYRA 1,2



POPIS SVÍTIDEL

Svítidla tvoří montura z kovu a skleněné stínítko
 Držení stínítka - sklapovací držáky
 Montáž - na stěnu

DESCRIPTION OF THE LIGHTING FITTINGS

The lighting fittings consist of the metal fixture and the glass shade
 Shade attachment - with folding two-step clamp holders
 Assembly - on the wall

ОПИСАНИЕ СВЕТИЛЬНИКОВ

Светильники состоят из металлического основания и стеклянного светорассеивателя
 Крепление рассеивателя - фиксаторы-защелки
 Установка - настенный / потолочный

BESCHREIBUNG DER LEUCHTEN

Die Leuchten bestehen aus einer Stahlblecharmatur und einer Glasabdeckung
 Halterung der Abdeckscheibe - klappbare Halterungen
 Montage - als Wandleuchten





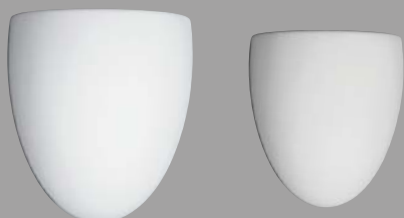
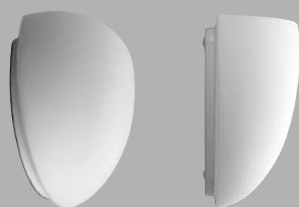



DESCRIPTION DES LUMINAIRES

Tous les luminaires d'intérieur se composent d'une monture métallique et d'un abat-jour en verre
 Fixation de l'abat-jour - supports à deux positions
 Montage - sur un mur



LYRA1

LYRA 1 IP43

Kód code код	typ type тип	Zdroj source лампа	příkon input [W]	objímka socket патрон	T [h]
A					
42500	IN-12U4/245		75	E27	
VVG					
42501	IN-15U4/245		18	G24d2	
42502	IN-16U4/245		26	G24d3	
EVG					
42503	E-15U4/245		18	G24q2	
42504	E-16U4/245		26	G24q3	
S					
46122	IN-12U4/245 HF		60	E27	
N					
42505	NZ-13/245		13	G24q1	1,0
NE					
42506	NK-E-18/245		18	G24q2	1,0
42507	NK-E-26/245		26	G24q3	1,0

LED IP43

Kód code код	kód code код	typ type тип	[lm]	[lm]	příkon input [W]	T [h]	záruka Guarantee [years]
	3000K	4000K	3000K	4000K			
49153	49653	LED-4L02A07U4/245.000	1840	1970	20		5



250x280 mm





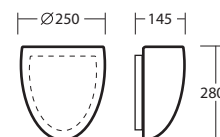





Náhradní stínítko/spare shade/запасное стекло

Kód/code/код	Typ/Type/тип	a x b/[mm]
20046	245	250x280



LYRA 2

LYRA 2 IP43

Kód code код	typ type тип	Zdroj source лампа	příkon input [W]	objímka socket патрон	T [h]
A					
42510	IN-22U6/265		2x75	2xE27	
VVG					
42511	IN-25U6/265		2x18	2xG24d2	
42512	IN-26U6/265		2x26	2xG24d3	
EVG					
42513	E-25U6/265		2x18	2xG24q2	
42514	E-26U6/265		2x26	2xG24q3	
S					
46123	IN-12U6/265 HF		75	E27	
N					
42515	NZ-18/265		18	G24q2	1,0
NE					
42518	NK-E-36/265		36	2G10	1,0
46210	NKC-218/13/265		2x18	2xG24q2	1,0
46303	NKC-226/13/265		2x26	2xG24q3	1,0

LED IP43

Kód code код	kód code код	typ type тип	[lm]	[lm]	příkon input [W]	T [h]	záruka Guarantee [years]
	3000K	4000K	3000K	4000K			
49154	49654	LED-5L02A10U6/265.000	3080	3280	37		5



350x390 mm

Náhradní stínítko/spare shade/запасное стекло

Kód/code/код	Typ/Type/тип	a x b/[mm]
20047	265	350x390

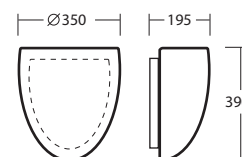

NEVA 1,2

**POPIS SVÍTIDEL**

Svítidla tvoří montura z kovu a skleněné stínítko
 Držení stínítka - sklapovací držáky
 Montáž - na stěnu nebo na strop

DESCRIPTION OF THE LIGHTING FITTINGS

The lighting fittings consist of the metal fixture and the glass shade
 Shade attachment - with folding two-step clamp holders
 Assembly - to the ceiling or on the wall

ОПИСАНИЕ СВЕТИЛЬНИКОВ

Светильники состоят из металлического основания и стеклянного светорассеивателя
 Крепление рассеивателя - фиксаторы - защелки
 Установка - на стену, на потолок

BESCHREIBUNG DER LEUCHTEN

Die Leuchten bestehen aus einer Stahlblecharmatur und einer Glasabdeckung
 Halterung der Abdeckscheibe - klappbare Halterungen
 Montage - als Wand- oder Deckenleuchten



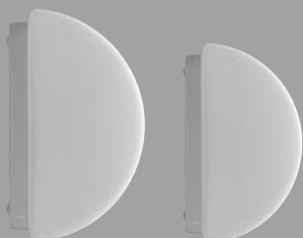
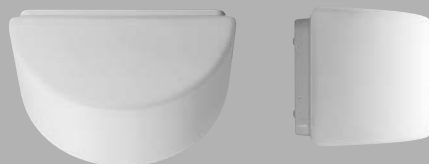

DESCRIPTION DES LUMINAIRES

Tous les luminaires d'intérieur se composent d'une monture métallique et d'un abat-jour en verre
 Fixation de l'abat-jour - supports basculants à deux positions
 Montage - sur un plafond ou sur un mur



NEVA 1

NEVA 1 IP43

Kód code код	typ type тип	Zdroj source лампа	přikon input [W]	objímka socket патрон	T [h]
A					
41609	IN-12U8/226		60	E27	
VVG					
41612	IN-14U8/226		13	G24d1	
EVG					
41613	E-14U8/226		13	G24q1	
N					
41614	NZ-7/226		7	2G7	1,0

LED IP43

Kód code код	kód code код	typ type тип	[lm]	[lm]	přikon input [W]	T [h]	záruka Guarantee [years]
	3000K	4000K	3000K	4000K			
49155	49655	LED-2L02A07U8/226.000	920	990	11		5



120x240 mm





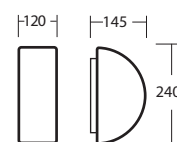







Náhradní stínítko/spare shade/запасное стекло

Kód/code/код	Typ/Type/тип	a x b/[mm]
20024	226	120x240



NEVA 2

NEVA 2 IP43

Kód code код	typ type тип	Zdroj source лампа	přikon input [W]	objímka socket патрон	T [h]
A					
41615	IN-12U9/228		100	E27	
41616	IN-22U9/228		2x60	2xE27	
VVG					
41618	IN-16U9/228		26	G24d3	
41619	IN-24U9/228		2x13	2xG24d1	
41620	IN-25U9/228		2x18	2xG24d2	
EVG					
41622	E-16U9/228		26	G24q3	
41623	E-24U9/228		2x13	2xG24q1	
41624	E-25U9/228		2x18	2xG24q2	
S					
46124	IN-12U9/228 HF		75	E27	
N					
41625	NZ-13/228		13	G24q1	1,0
NE					
41629	NK-E-18/228		18	G24q2	1,0
41630	NK-E-26/228		26	G24q3	1,0

LED IP43

Kód code код	kód code код	typ type тип	[lm]	[lm]	přikon input [W]	T [h]	záruka Guarantee [years]
	3000K	4000K	3000K	4000K			
49156	49656	LED-4L02A07U9/228.000	1840	1970	20		5



170x340 mm

Náhradní stínítko/spare shade/запасное стекло

Kód/code/код	Typ/Type/тип	a x b/[mm]
20025	228	170x340

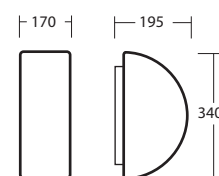

ALMA 1,2

**POPIS SVÍTIDEL**

Svítidla tvoří montura z kovu a skleněné stínítko
 Držení stínítka - sklapovací držáky
 Montáž - na stěnu nebo na strop

DESCRIPTION OF THE LIGHTING FITTINGS

The lighting fittings consist of the metal fixture and the glass shade
 Shade attachment - with folding two-step clamp holders
 Assembly - to the ceiling or on the wall

ОПИСАНИЕ СВЕТИЛЬНИКОВ

Светильники состоят из металлического основания и стеклянного светорассеивателя
 Крепление рассеивателя - фиксаторы - защелки
 Установка - на стену, на потолок

BESCHREIBUNG DER LEUCHTEN

Die Leuchten bestehen aus einer Stahlblecharmatur und einer Glasabdeckung
 Halterung der Abdeckscheibe - klappbare Halterungen
 Montage - als Wand- oder Deckenleuchten

DESCRIPTION DES LUMINAIRES

Tous les luminaires d'intérieur se composent d'une monture métallique et d'un abat-jour en verre
 Fixation de l'abat-jour - supports basculants à deux positions
 Montage - sur un plafond ou sur un mur





POPIS SVÍTIDEL S DEKORATIVNÍMI LÍMCI

Dekoratívni límec – je součástí montury

Upozornění: veškerá svítidla s dekorativními límci lze vybavit i LED zdroji – viz ALMA 1,2

DESCRIPTION OF THE LIGHTING FITTINGS WITH DECORATIVE RINGS

Decorative ring – metal – is the part of the fixture

Notice: It is possible to equip all the light fittings with decorative rings with LED –sources too- see ALMA 1,2

ОПИСАНИЕ СВЕТИЛЬНИКОВ С ДЕКОРАТИВНЫМИ ЭЛЕМЕНТАМИ

Декоративный элемент – является составной частью основания.

Внимание: все светильники с декоративными элементами могут быть оборудованы светодиодными модулями – см. ALMA 1,2

BESCHREIBUNG DER LEUCHTEN MIT DEKORATIVEM METALLRING

Decorativer Ring – Bestandteil der Armatur

Hinweis: Sämtliche Leuchten mit dekorativen Metallringen können auch mit einer LED –Lampe ausgestattet werden- siehe ALMA 1,2

DESCRIPTION DES LUMINAIRES AVEC COL DÉCORATIF

Cól décoratif – se trouve dans la monture

Remarque: Tous le luminaires avec col décoratif peuvent également être équipés de LED – voir ALMA 1,2



Dekoratívni límec / Decorative ring / Декоративное кольцо (цвет) / Dekorativer Ring/col décoratif

S4	bílá/white/белый/Weiß/blanche
S11	chrom/chrome/хром/Chrom/chrome
S12	mosaz/brass/латунь/Messing/laiton
S13	matný chrom/matt chrome/матовый хром/Mattchrom/chrome mat

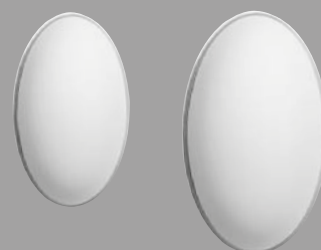

ALMA 1



150x250 mm

Náhradní stínítko/spare shade/запасное стекло

Kód/code/код	Typ/Type/тип	a x b/ [mm]
20026	121	150x250

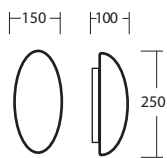

170x270 mm

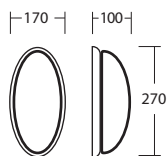

ALMA 1 IP41

Kód code код	typ type тип	Zdroj source лампа	příkon input [W]	objímka socket патрон	T [h]
A					
41631	IN-12U1/121		60	E27	
VVG					
41632	IN-14U1/121		13	G24d1	
EVG					
41633	E-14U1/121		13	G24q1	
N					
41634	NZ-7/121		7	2G7	1,0











LED IP41

Kód code код	kód code код	typ type тип	[lm] 3000K	[lm] 4000K	příkon input [W]	T [h]	záruka Guarantee [years]
49158	49658	LED-2L02A07U1/121.000	920	990	11		5

ALMA D1 IP41

kód/S4 code/S4 код/S4	kód/S11 code/S11 код/S11	kód/S12 code/S12 код/S12	kód/S13 code/S13 код/S13	typ type тип	příkon input [W]	objímka socket патрон	T [h]
A							
41647	41651	41655	41659	IN-12U1/121/S..	60	E27	
EVG							
41649	41653	41657	41661	E-14U1/121/S..	13	G24q1	
N							
41650	41654	41658	41662	NZ-7/121/S..	7	2G7	1,0

ALMA 2 IP41

Kód code код	typ type тип	Zdroj source лампа	příkon input [W]	objímka socket патрон	T [h]
A					
41635	IN-12U2/123		100	E27	
41636	IN-22U2/123		2x60	2xE27	
VVG					
41638	IN-15U2/123		18	G24d2	
41639	IN-16U2/123		26	G24d3	
41640	IN-24U2/123		2x13	2xG24d1	
EVG					
41642	E-15U2/123		18	G24q2	
41643	E-16U2/123		26	G24q3	
41644	E-24U2/123		2x13	2xG24q1	
S					
46125	IN-12U2/123 HF		60	E27	
N					
41645	NZ-13/123		13	G24q1	1,0
NE					
41646	NK-E-13/123		13	G24q1	1,0

LED IP41

Kód code код	kód code код	typ type тип	[lm]	[lm]	příkon input [W]	T [h]	záruka Guarantee [years]
	3000K	4000K	3000K	4000K			
49159	49659	LED-4L02A07U2/123.000	1840	1970	20		5

ALMA D2 IP41

kód/S4 code/S4 код/S4	kód/S11 code/S11 код/S11	kód/S12 code/S12 код/S12	kód/S13 code/S13 код/S13	typ type тип	příkon input [W]	objímka socket патрон	T [h]
A							
41663	41675	41687	41699	IN-12U2/123/S..	100	E27	
41664	41676	41688	41700	IN-22U2/123/S..	2x60	2xE27	
EVG							
41670	41682	41694	41706	E-15U2/123/S..	18	G24q2	
41671	41683	41695	41707	E-16U2/123/S..	26	G24q3	
41672	41684	41696	41708	E-24U2/123/S..	2x13	2xG24q1	
S							
46175	46176	46177	46178	IN-12U2/123/S.. HF	60	E27	
N							
41673	41685	41697	41709	NZ-13/123/S..	13	G24q1	1,0
NE							
41674	41686	41698	41710	NK-E-13/123/S..	13	G24q1	1,0



205x350 mm

Náhradní stínítko/spare shade/запасное стекло

Kód/code/код	Typ/Type/тип	a x b / [mm]
20027	123	205x350

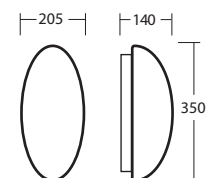

225x370 mm

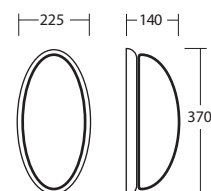

PYRAMUS

1,2,3



POPIS SVÍTIDEL

Svítidla tvoří montura z kovu a skleněné stínítka
 Držení stínítka - sklapovací držáky
 Montáž - na stěnu nebo na strop

DESCRIPTION OF THE LIGHTING FITTINGS

The lighting fittings consist of the metal fixture and the glass shade
 Shade attachment - with folding two-step clamp holders
 Assembly - to the ceiling or on the wall

ОПИСАНИЕ СВЕТИЛЬНИКОВ

Светильники состоят из металлического основания и стеклянного светорассеивателя
 Крепление рассеивателя - фиксаторы - защелки
 Установка - на стену, на потолок

BESCHREIBUNG DER LEUCHTEN

Die Leuchten bestehen aus einer Stahlblecharmatur und einer Glasabdeckung
 Halterung der Abdeckscheibe - klappbare Halterungen
 Montage - als Wand- oder Deckenleuchten

DESCRIPTION DES LUMINAIRES

Tous les luminaires d'intérieur se composent d'une monture métallique et d'un abat-jour en verre
 Fixation de l'abat-jour - supports basculants à deux positions
 Montage - sur un plafond ou sur un mur

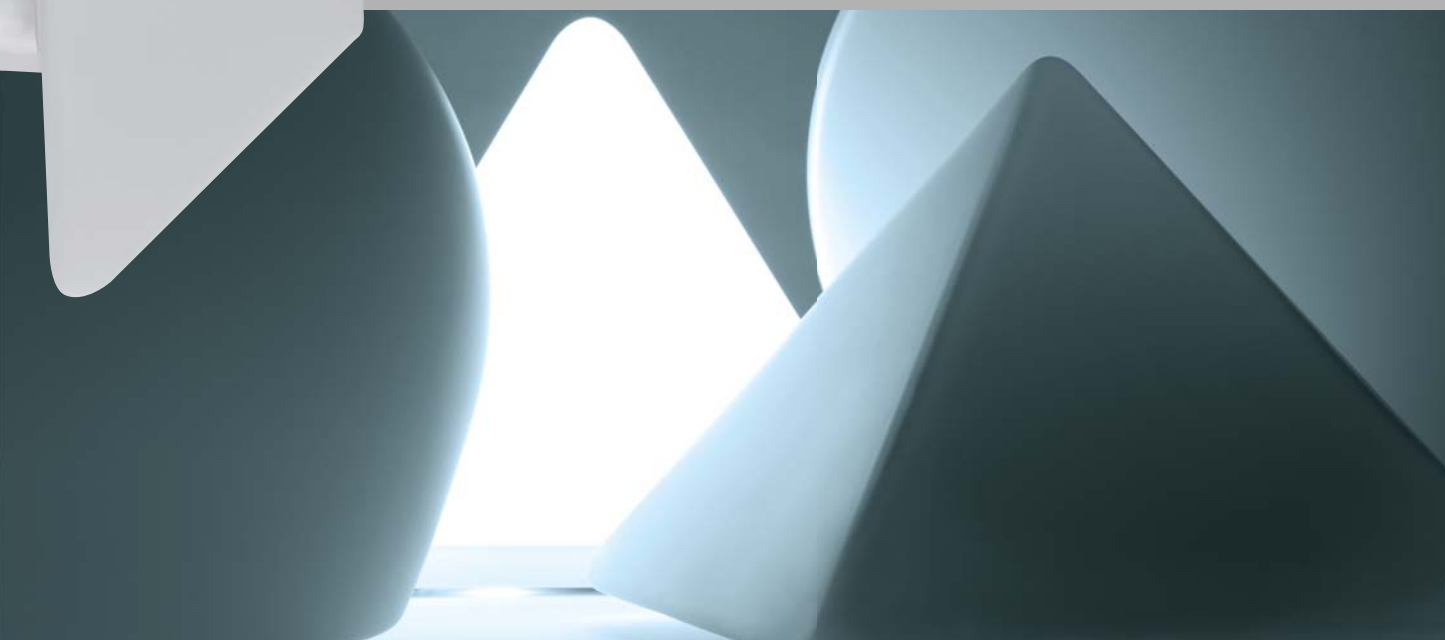

PYRAMUS 1

PYRAMUS 1 IP43

Kód code код	typ type тип	Zdroj source лампа	příkon input [W]	objímka socket патрон	T [h]
--------------------	--------------------	--------------------------	------------------------	-----------------------------	----------

A

44962	IN-12U3/323		100	E27	
-------	-------------	---	-----	-----	--

EVG

44963	E-16U3/323		26	G24q3	
-------	------------	---	----	-------	--

LED IP43

Kód code код	kód code код	typ type тип	[lm] 3000K	[lm] 4000K	příkon input [W]	T [h]	záruka Guarantee [years]
49301	49801	LED-3L02A07U3/323.000	1380	1470	15		5

NOVINKA/NEW

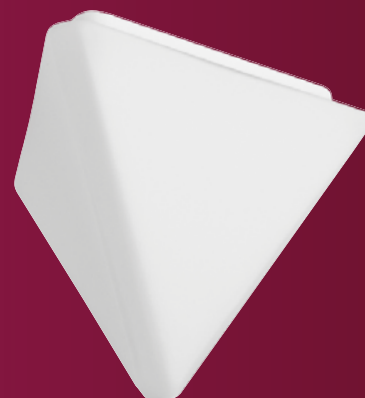

260x300 mm

Náhradní stínítko/spare shade/запасное стекло

Kód/code/код	Typ/Type/тип	a x b/ [mm]
20085	323	260x300

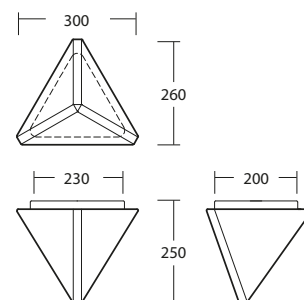

PYRAMUS 2

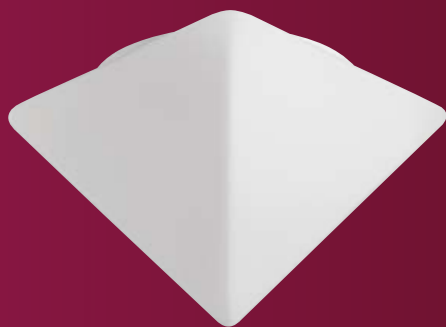
NOVINKA/NEW

320x320 mm
Náhradní stínítko/spare shade/запасное стекло

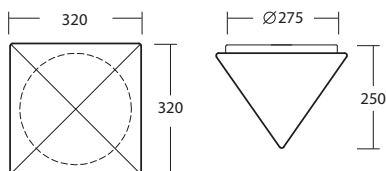
Kód/code/код	Typ/Type/тип	a x b/ [mm]
20086	324	320x320









PYRAMUS 2 IP43

Kód code код	typ type тип	Zdroj source лампа	příkon input [W]	objímka socket патрон	T [h]
A					
44964	IN-22K65/324		2x75	2xE27	
EVG					
44965	E-25K65/324		2x18	2xG24q2	
44966	E-16K65/324		26	G24q3	
DIM					
44967	ES-25K65/324 1-10V		2x18	2xG24q2	
44968	ES-25K65/324 DALI		2x18	2xG24q2	
S					
44969	IN-12K65/324 HF		75	E27	
44970	E-16K65/324 HF		26	G24q3	
NE					
44971	NK-E-26/324		26	G24q3	1,0

LED IP43

Kód code код	kód code код	typ type тип	[lm] 3000K	[lm] 4000K	příkon input [W]	T [h]	záruka Guarantee [years]
49302	49802	LED-1L13A07K65/324.000	1480	1480	16		3
49303	49803	LED-4L02A07K65/324.000	1840	1970	20		5*
49304	49804	LED-4L02A10K65/324.000	2460	2630	30		5*
DIM							
49305	49805	LED-4L02A10K65/324 1-10V.000	2460	2630	30		5
49306	49806	LED-4L02A10K65/324 DALI.000	2460	2630	30		5
S							
49307	49807	LED-1L13A07K65/324 HF.000	1480	1480	16		3
49308	49808	LED-4L02A10K65/324 HF.000	2460	2630	30		5*
NE							
49309	49809	LED-1L13A07K65/324/NK1W.000	1480	1480	16	3,0	3
49310	49810	LED-4L02A10K65/324/NK1W.000	2460	2630	30	3,0	5*

PYRAMUS 3 IP43

Kód code код	typ type тип	Zdroj source лампа	přikon input [W]	objímka socket патрон	T [h]
A					
44972	IN-22K65/334		2x75	2xE27	
EVG					
44973	E-25K65/334		2x18	2xG24q2	
DIM					
44974	ES-25K65/334 1-10V		2x18	2xG24q2	
44975	ES-25K65/334 DALI		2x18	2xG24q2	
S					
44976	IN-12K65/334 HF		75	E27	
44977	E-16K65/334 HF		26	G24q3	
NE					
44978	NK-E-26/334		26	G24q3	1,0

LED IP43

Kód code код	kód code код	typ type тип	[lm] 3000K	[lm] 4000K	přikon input [W]	T [h]	záruka Guarantee [years]
49311	49811	LED-1L13A07K65/334 .000	1480	1480	16		3
49312	49812	LED-4L02A07K65/334 .000	1840	1970	20		5*
49313	49813	LED-4L02A10K65/334 .000	2460	2630	30		5*
DIM							
49314	49814	LED-4L02A10K65/334 1-10V .000	2460	2630	30		5
49315	49815	LED-4L02A10K65/334 DALI .000	2460	2630	30		5
S							
49316	49816	LED-1L13A07K65/334 HF .000	1480	1480	16		3
49317	49817	LED-4L02A10K65/334 HF .000	2460	2630	30		5*
NE							
49318	49818	LED-1L13A07K65/334/NK1W .000	1480	1480	16	3,0	3
49319	49819	LED-4L02A10K65/334/NK1W .000	2460	2630	30	3,0	5*

NOVINKA/NEW

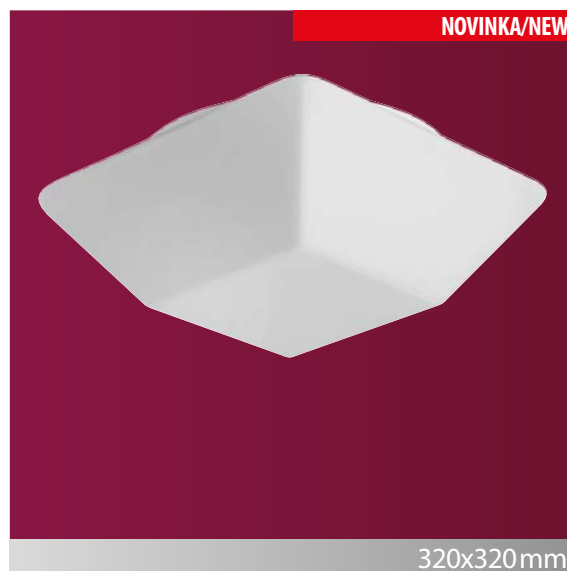

320x320 mm

Náhradní stínítko/spare shade/запасное стекло

Kód/code/код	Typ/Type/тип	a x b/ [mm]
20087	334	320x320

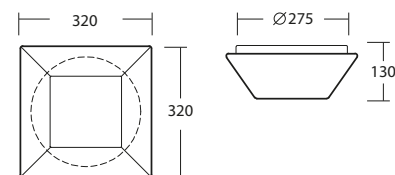

**POPIS SVÍTIDEL**

Svítidla tvoří montura z kovu, skleněné stínítko a dekorativní kovový límeček

- Držení stínítka - sklapovací držáky
 Montáž - na strop
 Dekorativní límeček - volně podložený pod stínítkem

DESCRIPTION OF THE LIGHTING FITTINGS

The lighting fittings consist of the metal fixture, the glass shade and the decorative metal ring

- Shade attachment - with folding two-step clamp holders
 Assembly - to the ceiling
 Decorative ring - is freely placed under the shade

ОПИСАНИЕ СВЕТИЛЬНИКОВ

Светильники состоят из металлического основания, стеклянного светорассеивателя и декоративного металлического кольца

- Крепление рассеивателя - фиксаторы - защелки
 Установка - потолочный
 Декоративное кольцо - установлено свободно под светорассеивателем

BESCHREIBUNG DER LEUCHTEN

Die Leuchten bestehen aus einer Stahlblecharmatur, einer Glasabdeckung und einem dekorativen Metallring

- Halterung der Abdeckscheibe - klappbare Halterungen
 Montage - als Wandleuchte
 Der dekorative Metallring - ist der Abdeckscheibe frei untergesetzt

DESCRIPTION DES LUMINAIRES

Tous les luminaires d'intérieur se composent d'une monture métallique, d'un abat-jour en verre et un col décoratif

- Fixation de l'abat-jour - supports basculants à deux positions
 Montage - sur un plafond
 Col décoratif - est calé discrètement sous l'abat-jour

**Dekorativní límeček / Decorative ring / Декоративное кольцо / Dekorativer Ring / col décoratif**

DK4	bílý lak/white paint/ белый лак /Weißlack/Laqué blanc
DK12	mosaz/brass/ латунь/Messing/laiton
DK14	nerez leštěná/stainless steel polished/хром/Edelstahl poliert/innox poli
DK15	nerez broušená/stainless steel ground/матовый хром/Edelstahl geschliffen/innox émoulu

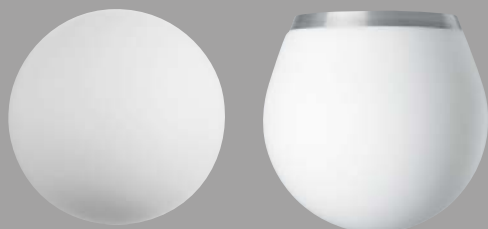

ORCUS DK IP41

kód/DK4 code/DK4 код/DK4	kód/DK12 code/DK12 код/DK12	kód/DK14 code/DK14 код/DK14	kód/DK15 code/DK15 код/DK15	typ type тип	příkon input [W]	objímka socket патрон	T [h]
A							
45660	45661	45662	45663	IN-12K56/472/DK..	100	E27	
EVG							
45664	45665	45666	45667	E-16K56/472/DK..	26	G24q3	
45668	45669	45670	45671	E-26K56/472/DK..	2x26	2xG24q3	
S							
45672	45673	45674	45675	IN-12K56/472/DK.. HF	60	E27	
45676	45677	45678	45679	E-16K56/472/DK.. HF	26	G24q3	
NE							
45680	45681	45682	45683	NK-E-26/472/DK..	26	G24q3	1,0

LED IP41

kód/DK4 code/DK4 код/DK4	kód/DK12 code/DK12 код/DK12	kód/DK14 code/DK14 код/DK14	kód/DK15 code/DK15 код/DK15	typ type тип	[lm]	příkon input [W]	T [h]	G [years]
3000K								
49325	49326	49327	49328	LED-1L12A07K56/472/DK.. 3000	980	11		3
49329	49330	49331	49332	LED-3L02A07K56/472/DK.. 3000	1380	15		5*
49333	49334	49335	49336	LED-3L02A10K56/472/DK.. 3000	1850	23		5*
DIM								
49337	49338	49339	49340	LED-3L02A10K56/472/DK.. 1-10V 3000	1850	23		5
49341	49342	49343	49344	LED-3L02A10K56/472/DK.. DALI 3000	1850	23		5
S								
49345	49346	49347	49348	LED-1L12A07K56/472/DK.. HF 3000	980	11		3
49349	49350	49351	49352	LED-3L02A10K56/472/DK.. HF 3000	1850	23		5
NE								
49353	49354	49355	49356	LED-1L12A07K56/472/NK1W/DK.. 3000	980	11	3,0	3
49357	49358	49359	49360	LED-3L02A07K56/472/NK1W/DK.. 3000	1380	15	3,0	5
4000K								
49825	49826	49827	49828	LED-1L12A07K56/472/DK.. 4000	980	11		3
49829	49830	49831	49832	LED-3L02A07K56/472/DK.. 4000	1470	15		5*
49833	49834	49835	49836	LED-3L02A10K56/472/DK.. 4000	1970	23		5*
DIM								
49837	49838	49839	49840	LED-3L02A10K56/472/DK.. 1-10V 4000	1970	23		5
49841	49842	49843	49844	LED-3L02A10K56/472/DK.. DALI 4000	1970	23		5
S								
49845	49846	49847	49848	LED-1L12A07K56/472/DK.. HF 4000	980	11		3
49849	49850	49851	49852	LED-3L02A10K56/472/DK.. HF 4000	1970	23		5
NE								
49853	49854	49855	49856	LED-1L12A07K56/472/NK1W/DK.. 4000	980	11	3,0	3
49857	49858	49859	49860	LED-3L02A07K56/472/NK1W/DK.. 4000	1470	15	3,0	5

NOVINKA/NEW



Náhradní stínítko/spare shade/запасное стекло

Kód/code/код	Typ/Type/тип	D [mm]
20101	472	350

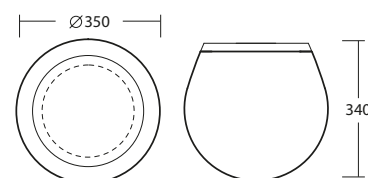

STYX 1,2,3,4



POPIS SVÍTIDEL

Svítidla tvoří montura z polykarbonátu a skleněné stínítko

- Montura - bílá nebo černá
 Držení stínítka - bajonetové
 Montáž - **na strop STYX 1,2,3,4**
 - **na stěnu STYX 1,2,3**

DESCRIPTION OF THE LIGHTING FITTINGS

The lighting fitting consist of the plastic fixture and the glass shade

- Fixture - white or black
 Shade attachment - with bayonet
 Assembly - **to the ceiling STYX 1,2,3,4**
 - **on the wall STYX 1,2,3**

ОПИСАНИЕ СВЕТИЛЬНИКОВ

Светильники состоят из поликарбонатного основания и стеклянного светорассеивателя

- Основание - белого или черного цвета
 Крепление рассеивателя - резьбовое соединение «байонет»
 Установка - **на потолок STYX 1,2,3,4**
 - **на стену STYX 1,2,3**

BESCHREIBUNG DER LEUCHTEN

Die Leuchten bestehen aus einer Kunststoffarmatur und einer Glasabdeckung

- Armatur - Weiß oder Schwarz
 Halterung der Abdeckscheibe - Bajonettverschluss
 Montage - **als Deckenleuchten STYX 1,2,3,4**
 - **als Wandleuchten STYX 1,2,3**

DESCRIPTION DES LUMINAIRES

Tous les luminaires se composent d'une abat-jour en verre et d'une monture plastique

- Monture - blanc ou noir
 Fixation - fixation par baionnette
 Montage - **sur un plafond STYX 1,2,3,4**
 - **sur un mur STYX 1,2,3**

Montura/fixture/ Основание /armatur/Monture

B bílá/white/белый/Weiß/blanche

C černá/black/черный/Schwarz/noir

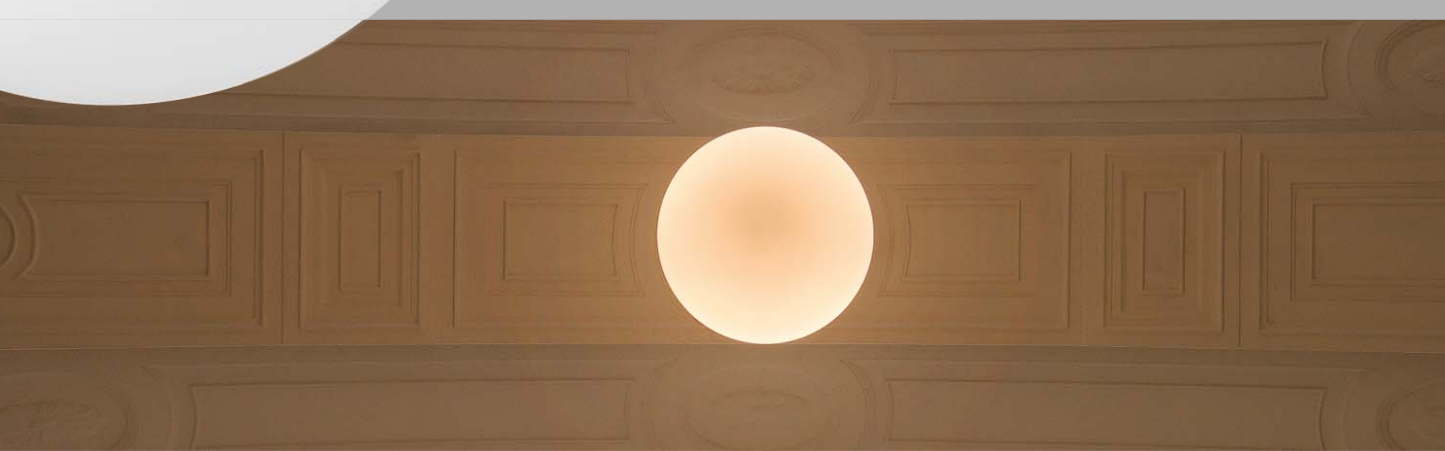



STYX 1

STYX 1 IP65

kód code код	typ type тип	Zdroj source лампа	příkon input [W]	objímka socket патрон
--------------------	--------------------	--------------------------	------------------------	-----------------------------

bílá/white/белый/Weiß/blanche

A 				
43971	IN-12BD1/192 B		25	E27

EVG

58020	E-14BD1/192 B		13	G24q1
-------	---------------	---	----	-------

černá/black/ черного цвета/ Schwarz/noir

A 				
58021	IN-12BD1/192 C		25	E27

EVG

58022	E-14BD1/192 C		13	G24q1
-------	---------------	---	----	-------

NOVINKA/NEW



Ø 200 mm

Náhradní stínítko/spare shade/запасное стекло

Kód/code/код	Typ/Type/тип	D [mm]
20092	192	200

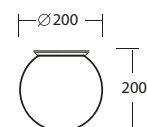

STYX 2

STYX 2 IP65

kód code код	typ type тип	Zdroj source лампа	příkon input [W]	objímka socket патрон
--------------------	--------------------	--------------------------	------------------------	-----------------------------

bílá/white/белый/Weiß/blanche

A 				
43972	IN-12BD1/193 B		40	E27

EVG

58023	E-15BD1/193 B		18	G24q2
-------	---------------	---	----	-------

černá/black/ черного цвета/ Schwarz/noir

A 				
58024	IN-12BD1/193 C		40	E27

EVG

58025	E-15BD1/193 C		18	G24q2
-------	---------------	---	----	-------

NOVINKA/NEW



Ø 250 mm

Náhradní stínítko/spare shade/запасное стекло

Kód/code/код	Typ/Type/тип	D [mm]
20093	193	250

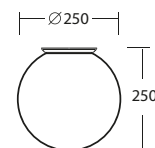

STYX 3

NOVINKA/NEW



Ø 300 mm

Náhradní stínítko/spare shade/запасное стекло

Kód/code/код	Typ/Type/тип	D [mm]
20094	194	300

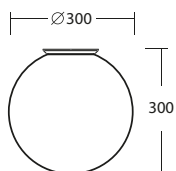

STYX 3 IP65

kód code код	typ type тип	Zdroj source лампа	příkon input [W]	objímka socket патрон
--------------------	--------------------	--------------------------	------------------------	-----------------------------

bílá/white/белый/Weiß/blanche

A

43973	IN-12BD1/194 B		60	E27
-------	----------------	--	----	-----

EVG

58026	E-16BD1/194 B		26	G24q3
-------	---------------	--	----	-------

černá/black/ черного цвета/ Schwarz/noir

A

58027	IN-12BD1/194 C		75	E27
-------	----------------	--	----	-----

EVG

58028	E-16BD1/194 C		26	G24q3
-------	---------------	--	----	-------

STYX 4

NOVINKA/NEW

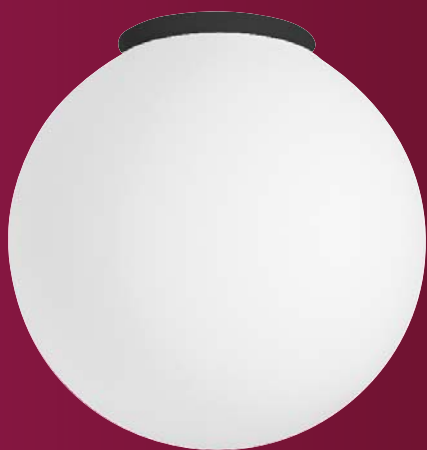

Ø 400 mm

Náhradní stínítko/spare shade/запасное стекло

Kód/code/код	Typ/Type/тип	D [mm]
20095	196	400

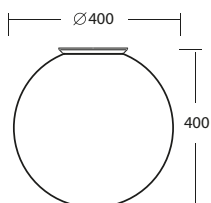

STYX 4 IP65

kód code код	typ type тип	Zdroj source лампа	příkon input [W]	objímka socket патрон
--------------------	--------------------	--------------------------	------------------------	-----------------------------

bílá/white/белый/Weiß/blanche

A

43975	IN-12BD1/196 B		75	E27
-------	----------------	--	----	-----

EVG

43970	E-26BD1/196 B		2x26	2xG24q3
-------	---------------	--	------	---------

černá/black/ черного цвета/ Schwarz/noir

A

58029	IN-12BD1/196 C		75	E27
-------	----------------	--	----	-----

EVG

58030	E-26BD1/196 C		2x26	2xG24q3
-------	---------------	--	------	---------



KIRA 1,2

**POPIS SVÍTIDEL**

Svítidla tvoří montura z kovu a skleněné stínítko

Držení stínítka - bajonetové

Montáž - na strop

DESCRIPTION OF THE LIGHTING FITTINGS

The lighting fitting consist of the metal fixture and glass shade

Shade attachment - with bayonet

Assembly - to the ceiling

ОПИСАНИЕ СВЕТИЛЬНИКОВ

Светильники состоят из металлического основания и стеклянного светорассеивателя

Крепление рассеивателя - резьбовое соединение «байонет»

Установка - потолочный

BESCHREIBUNG DER LEUCHTEN

Die Leuchten bestehen aus einer Stahlblecharmatur und einer Glasabdeckung.

Halterung der Abdeckscheibe - Bajonettverschluss

Montage - als Wandleuchte

DESCRIPTION DES LUMINAIRES

Tous les luminaires d'intérieur se composent d'une monture métallique et d'un abat-jour en verre

Fixation de l'abat-jour - fixation par baionnette

Montage - sur un plafond

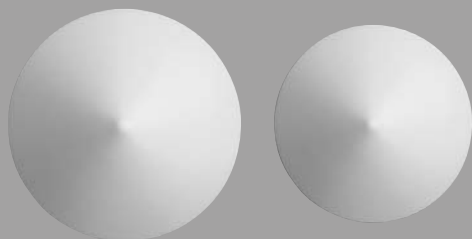



POPIS SVÍTIDEL S DEKORATIVNÍMI LÍMCI

Svítidla tvoří montura z kovu, skleněné stínítko a dekorativní kovový límeček

Dekorativní límeček - volně podložený pod stínítkem

Upozornění: veškerá svítidla s dekorativními límci lze vybavit i LED zdroji – viz KIRA 1,2

DESCRIPTION OF THE LIGHTING FITTINGS WITH DECORATIVE RINGS

The lighting fittings consist of the metal fixture, the glass shade and the decorative metal ring

Decorative ring - is freely placed under the shade

Notice: it is possible to equip all the light fittings with decorative rings with LED sources too - see KIRA 1,2

ОПИСАНИЕ СВЕТИЛЬНИКОВ С ДЕКОРАТИВНЫМИ ЭЛЕМЕНТАМИ

Светильники состоят из металлического основания, стеклянного светорассеивателя и декоративного металлического кольца

Декоративное кольцо - установлено свободно под светорассеивателем

Внимание: все светильники с декоративными кольцами могут быть изготовлены со светодиодами – см. KIRA 1,2

BESCHREIBUNG DER LEUCHTEN MIT DEKORATIVEM METALLRING

Die Leuchten bestehen aus einer Stahlblecharmatur, einer Glasabdeckung und einem dekorativen Metallring

Dekoratives Zubehör - Metallring ist der Abdeckung frei untergesetzt

Hinweis: Sämtliche Leuchten mit dekorativen Ringen können auch mit LED-Lampen ausgestattet werden - siehe KIRA 1,2

DESCRIPTION DES LUMINAIRES AVEC COL DÉCORATIF

Tous les luminaires d'intérieur se composent d'une monture métallique, d'un abat-jour en verre et un col décoratif

Col décoratif - est calé discrètement sous l'abat-jour

Tous les luminaires avec col décoratif peuvent également être équipés de LED - voir KIRA 1,2



Dekorativní límeček / Decorative ring / Декоративное кольцо (цвет) / Dekorativer Ring / col décoratif

X4	bílá/white/белый/Weiß/blanche
X11	chrom/chrome/хром/Chrom/chrome
X12	mosaz/brass/латунь/Messing/laiton
X13	matný chrom/matt chrome/матовый хром/Mattchrom/chrome mat



KIRA 1



Ø 250 mm

Náhradní stínítko/spare shade/запасное стекло

Kód/code/код	Typ/Type/тип	D [mm]
20033	312	250

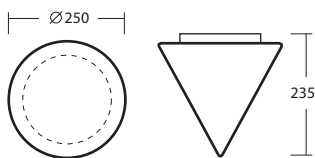

Ø 275 mm

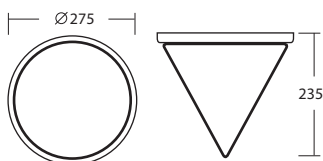

KIRA 1 IP44











Kód code код	typ type тип	Zdroj source лампа	příkon input [W]	objímka socket патрон	T [h]
A					
41741	IN-12BT12/312		75	E27	
VVG					
41742	IN-14BT12/312		13	G24d1	
EVG					
41743	E-14BT12/312		13	G24q1	
43150	E-15BT12/312		18	G24q2	
N					
41744	NZ-7/T/312		7	2G7	1,0

LED IP44

Kód code код	kód code код	typ type тип	[lm]		příkon input [W]	T [h]	záruka Guarantee [years]
			3000K	4000K			
49160	49660	LED-1L12A07BT12/312.000	980	980	11		3
49161	49661	LED-3L02A07BT12/312.000	1380	1470	15		5*
S							
49162	49662	LED-1L12A07BT12/312 HF.000	980	980	11		3
49163	49663	LED-3L02A07BT12/312 HF.000	1380	1470	15		5*
N							
-	49664	LED-NZ1W/312 4000		100	1	3,0	3

KIRA D1 IP20

kód/X4 code/X4 код/X4	kód/X11 code/X11 код/X11	kód/X12 code/X12 код/X12	kód/X13 code/X13 код/X13	typ type тип	příkon input [W]	objímka socket патрон	T [h]
A							
41770	41774	41778	41782	IN-12B12/312/X..	75	E27	
EVG							
41772	41776	41780	41784	E-14B12/312/X..	13	G24q1	
N							
41773	41777	41781	41785	NZ-7/312/X..	7	2G7	1,0

KIRA 2 IP44		Zdroj source лампа	přikon input [W]	objímka socket патрон	T [h]
Kód code код	typ type тип				
A					
41745	IN-12BT13/313		100	E27	
VVG					
41746	IN-15BT13/313		18	G24d2	
41747	IN-16BT13/313		26	G24d3	
41748	IN-24BT13/313		2x13	2xG24d1	
EVG					
41749	E-15BT13/313		18	G24q2	
41750	E-16BT13/313		26	G24q3	
41751	E-24BT13/313		2x13	2xG24q1	
43151	E-25BT13/313		2x18	2xG24q2	
S					
46126	IN-12BT13/313 HF		60	E27	
N					
41752	NZ-13/T/313		13	G24q1	1,0
NE					
41753	NK-E-13/T/313		13	G24q1	1,0

LED IP44				přikon input [W]	T [h]	záruka Guarantee [years]
Kód code код	kód code код	typ type тип				
3000K	4000K		[lm]	[lm]	[W]	[h]
49165	49665	LED-1L13A07BT13/313.000	1480	1480	16	3
49166	49666	LED-3L02A10BT13/313.000	1850	1970	23	5*
DIM						
49167	49667	LED-3L02A10BT13/313 1-10V.000	1850	1970	23	5
49168	49668	LED-3L02A10BT13/313 DALI.000	1850	1970	23	5
S						
49169	49669	LED-1L13A07BT13/313 HF.000	1480	1480	16	3
49170	49670	LED-3L02A10BT13/313 HF.000	1850	1970	23	5*
NE						
49171	49671	LED-1L13A07BT13/313/NK1W.000	1480	1480	16	3
49172	49672	LED-3L02A10BT13/313/NK1W.000	1850	1970	23	3

KIRA D2 IP20					přikon input [W]	objímka socket патрон	T [h]
kód/X4 code/X4 код/X4	kód/X11 code/X11 код/X11	kód/X12 code/X12 код/X12	kód/X13 code/X13 код/X13	typ type тип			
41830	41841	41852	41863	IN-12B13/313/X..	100	E27	
EVG							
41835	41846	41857	41868	E-15B13/313/X..	18	G24q2	
41836	41847	41858	41869	E-16B13/313/X..	26	G24q3	
41837	41848	41859	41870	E-24B13/313/X..	2x13	2xG24q1	
43156	43157	43158	43159	E-25B13/313/X..	2x18	2xG24q2	
S							
46179	46180	46181	46182	IN-12B13/313/X..HF	60	E27	
N							
41839	41850	41861	41872	NZ-13/313/X..	13	G24q1	1,0
NE							
41840	41851	41862	41873	NK-E-13/313/X..	13	G24q1	1,0

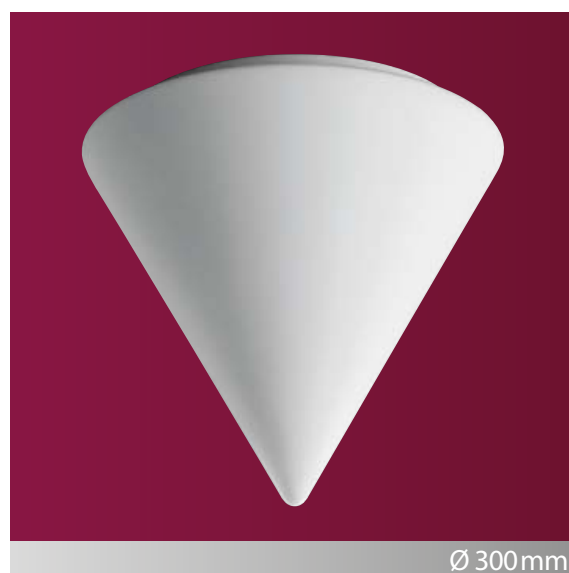

Ø 300 mm

Náhradní stínítko/spare shade/запасное стекло

Kód/code/код	Typ/Type/тип	D [mm]
20034	313	300

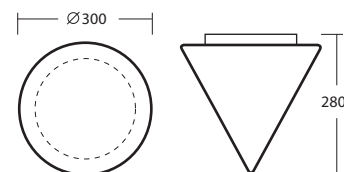

Ø 325 mm

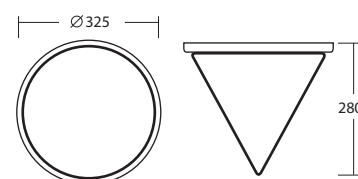

**POPIS SVÍTIDEL**

Svítidla tvoří montura z kovu a skleněné stínítka
Držení stínítka - šroubkové

DESCRIPTION OF THE LIGHTING FITTINGS

The lighting fittings consist of the metal fixture and the glass shade
Shade attachment - with screws

ОПИСАНИЕ СВЕТИЛЬНИКОВ

Светильники состоят из металлического основания и стеклянного светорассеивателя
Крепление рассеивателя - винтовое крепление

BESCHREIBUNG DER LEUCHTEN

Die Leuchten bestehen aus einer Stahlblecharmatur und einer Glasabdeckung.
Halterung der Abdeckscheibe - Schraubenhalterungen

DESCRIPTION DES LUMINAIRES

Tous les luminaires d'intérieur se composent d'une monture métallique et d'un abat-jour en verre
Fixation de l'abat-jour - supports par vis



S4



S11



S12



S13

Dekorativní límeč / Decorative ring / Декоративное кольцо (цвет) / Dekorativer Ring / col décoratif

S4 bílá/white/белый/Weiß/blanche

S11 chrom/chrome/хром/Chrom/chrome

S12 mosaz/brass/латунь/Messing/laiton

S13 matný chrom/matt chrome/матовый хром/Mattchrom/chrome mat



MIRA D IP41

kód/S4 code/S4 код/S4	kód/S11 code/S11 код/S11	kód/S12 code/S12 код/S12	kód/S13 code/S13 код/S13	typ type тип	příkon input [W]	objímka socket патрон	T [h]
A							
42430	42434	42438	42442	IN-12S6/195/S..	150	E27	
EVG							
42431	42435	42439	42443	E-26S6/195/S..	2x26	2xG24q3	
44634	44635	44636	44637	E-26S6/195/S.. 32W	2x32	2xGX24q3	
DIM							
42571	42574	42577	42580	ES-26S6/195/S.. 1-10V	2x26	2xG24q3	
42573	42576	42579	42582	ES-26S6/195/S.. DALI	2x26	2xG24q3	
S							
46183	46184	46185	46186	IN-12S6/195/S.. HF	75	E27	
NE							
42433	42437	42441	42445	NK-E-26/195/S..	26	G24q3	1,0



350x430 mm

Náhradní stínítko/spare shade/запасное стекло

Kód/code/код	Typ/Type/тип	a x b/размер [mm]
20049	195	350x390

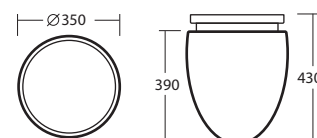

I.

ZÁVĚSNÁ SVÍTIDLA SE STÍNÍTKY ZE SKLA TRIPLEX OPÁL

PENDANT LIGHTING FITTINGS WITH TRIPLEX OPAL GLASS SHADES

ПОДВЕСНЫЕ СВЕТИЛЬНИКИ СО СВЕТОРАСSEИВАТЕЛЯМИ ИЗ ТРЕХСЛОЙНОГО ОПАЛОВОГО СТЕКЛА ТРИПЛЕКС ОПАЛ

PENDELLEUCHTEN MIT ABDECKUNGEN AUS TRIPLEX OPAL GLAS

LUMINAIRE SUSPENDU AVEC ABAT-JOUR EN TRIPLEX OPAL

ADRIA 1 100-103
L1, S1

ADRIA 2 104-106
L2, S2

ADRIA 3 107-109
L3, S3

ADRIA 4 110-112
L4, S4

ADRIA 5 113-115
L5, S5

ASTRA 116-118
L, S

DANAE 1,2 120-121

DANTE 1,2 122-123

SATURN L1,2 124-125

AURA P3,4,5 126-128

CRATER P3,4,5 128-129

DRACO P3,4,5 130-131

EDNA P3,4,5 131-132

AURA T5,9 134-135

CRATER T5 136

DRACO T5 136

EDNA T5 137

LINA L7 137

MIRA R 138-139

GALAXIA L 140-142



ADRIA 1-5 / L1-5 / S1-5



AURA P / CRATER P / DRACO P / EDNA P



ASTRA / ASTRA L / ASTRA S



AURA T / CRATER T / DRACO T / EDNA T



DANAE 1



LINA L7



DANAE 2



MIRA R



DANTE 1



GALAXIA



DANTE 2



SATURN L1,2

CZ POPIS SVÍTIDEL:

Svítidla tvoří tyčový, lankový nebo kabelový závěs a skleněné stínítko	
Stínítko	- třívrstvé, ručně vyráběné sklo TRIPLEX OPAL s matovaným povrchem
Závěs	- tyčový — ocelová nebo nerezová trubka o průměru 10mm - lankový — ocelové lanko a transparentní přívodní kabel - kabelový — transparentní nebo bílý kabel
Držení stínítka	- ocelový držák pro otvor 110mm (ADRIA DM.200 a 300mm) a pro otvor 150mm (ADRIA DM 400, 500 a 600mm) - sklápovací systémy
Montáž	- na strop
Použití	- bytová výstavba, hotely, školy, společenské prostory

EN DESCRIPTION OF THE LIGHTING FITTINGS:

The lighting fittings consist of the steel bar, wire or cable pendant and glass shade	
Shade	- three layers, hand blown glass TRIPLEX OPAL with matt surface
Pendant	- bar — steel or stainless steel bar Φ 10mm - wire — steel wire pendant and transparent supply cable - cable — transparent or white cable
Shade attachment	- steel holder for Φ 110 mm (ADRIA D. 200 and 300mm) and for Φ 150mm (ADRIA D.400,500,600) - clap holders
Assembly	- to the ceiling
Applications	- housing constructions, hotels, schools, cultural premises

RUS ОПИСАНИЕ СВЕТИЛЬНИКОВ:

Светильники состоят из жесткого, гибкого или кабельного подвеса и стеклянного светорассеивателя	
Светорассеиватель	- трехслойное, изготовленное вручную опаловое стекло триплекс (TRIPLEX OPAL) с матированной поверхностью
Подвес	- жесткий — металлическая трубка Φ 10 мм - гибкий — металлический трос и прозрачный электрический шнур - кабельный — прозрачный или белый кабель
Крепление рассеивателя	- металлическое крепление для отверстий 110 мм (ADRIA DM 200 и 300мм) и 150мм для (ADRIA DM 400, 500 и 600мм) - откидные фиксаторы - защелки
Установка	- потолочный
Назначение	- жилые помещения, гостиницы, школы, общественные помещения

DE BESCHREIBUNG DER LEUCHTEN:

Die Leuchten bestehen aus einer Stangen-,Seil- oder Kabelaufhängung und einer Glasabdeckung.	
Abdeckung	- mundgeblasenes Dreischichtglas TRIPLEX OPAL mit mattierter Oberfläche
Aufhängung	- Stangenaufhängung - Stahl oder Edelstahlrohr Φ 10 mm - Seilaufhängung — Edelstahl, transparentes Kabel - Kabelaufhängung — transparentes oder weiß Kabel
Halterung der Abdeckscheibe	- Stahlhalterung für Öffnung mit Φ 110 mm (Adria D.200 und 300mm) und für Öffnung mit 150 mm (Adria D. 400,500,600mm) - klappbare Halterungen
Montage	- als Deckenleuchten
Einsatz	- Wohnungsbau, Hotels, Schulen, Gemeinschaftsräume

F DESCRIPTION DES LUMINAIRES:

Tous les luminaires d'intérieur se composent d'une tige de suspension, suspension par fil ou suspension par câble et d'un abat-jour en verre	
Abat-jour	- à trois couches, verre soufflé travaillé manuellement TRIPLEX OPAL avec une surface matée
Suspension	- par tige (tube d'acier d'un diamètre de 10 mm, - par câble (câble inoxydable avec partie en acier laqué ou inoxydable, câble transparents) suspension par fil (fil inoxydable, câble transparents) câble de suspension — câble transparents ou blanc
Fixation de l'abat-jour	- tube d'acier pour l'ouverture 110 (ADRIA D. 200 et 300mm) et pour l'ouverture 150mm (ADRIA D. 400,500,600mm) - supports basculants à deux positions
Montage	- sur un plafond
Utilisation	- constructions locatives écoles, hôtels, locaux sociaux

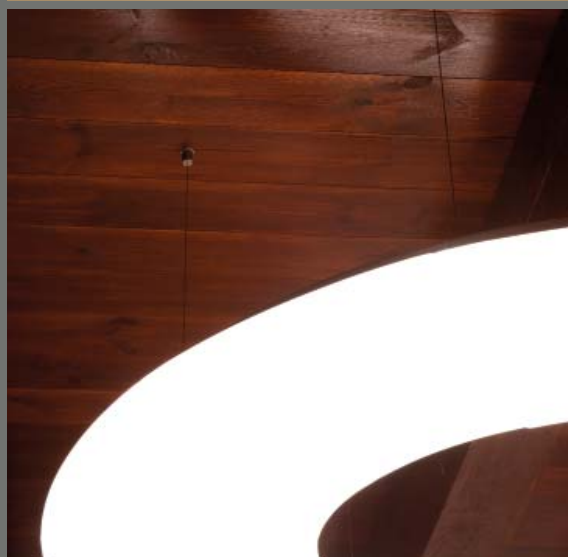

ADRIA 1-5
 ADRIA L1-5
 ADRIA S 1-5
 ASTRA
 ASTRA L
 ASTRA S



POPIS SVÍTIDEL

Svítidlo tvoří skleněné stínítko a tyčový (ADRIA), lankový (ADRIA L) a kabelový závěs (ADRIA S)
 Držení stínítka - ocelový držák pro otvor 110 mm (ADRIA 1,2) a pro otvor 150mm (ADRIA 3,4,5)
 Montáž - na strop
LED - svítidla mohou být vybavena LED moduly Osmont, celá nabídka na www.osmont.cz

DESCRIPTION OF THE LIGHTING FITTINGS

The lighting fitting consist of the glass shade and of the steel rod (ADRIA), wire (ADRIA L), and cable pendant (ADRIA S)
 Shade attachment - steel holder for Φ 110 mm (Adria 1,2) and for Φ 150mm (Adria 3,4,5)
 Assembly - to the ceiling
LED - lighting fittings can be equipped by LED moduls Osmont, see complete offer on: www.osmont.cz

ОПИСАНИЕ СВЕТИЛЬНИКОВ

Светильник состоит из стеклянного светорассеивателя и жесткого (ADRIA), гибкого (ADRIA L) и кабельного подвеса (ADRIA S)
 Крепление рассеивателя - металлическое крепление для отверстий 110 мм (Adria 1,2) и для отверстия 50 мм (Adria 3,4,5)
 Установка - потолочный
LED - светильники могут быть оборудованы светодиодами модулями Osmont, весь ассортимент на www.osmont.cz

BESCHREIBUNG DER LEUCHTEN

Die Leuchten bestehen aus einer Glasabdeckung und einer Stangenauflhängung (ADRIA), Seilaufhängung (ADRIA L) und Kabelaufhängung (ADRIA S)
 Halterung der Abdeckscheibe - Stahlhalterung für Öffnung mit Φ 110mm (Adria 1,2) und für Öffnung mit Φ 150mm (Adria 3,4,5)
 Montage - als Deckenleuchten
LED - Die Leuchten können mit den LED-Modulen Osmont bestückt werden, das Gesamtangebot finden Sie unter www.osmont.cz

DESCRIPTION DES LUMINAIRES

Tous les luminaires d'intérieur se composent d'un abat-jour en verre et d'une tige de suspension (ADRIA), suspension par une fil (ADRIA L) et suspension par cable (ADRIA S)
 Fixation de l'abat-jour - attache d'acier pour l'ouverture 110mm (Adria 1,2), et pour l'ouverture 150mm (Adria 3,4,5)
 Montage - sur un plafond
LED - Les luminaires peuvent être équipés de modules LED Osmont, toutes les offres sont sur www.osmont.cz

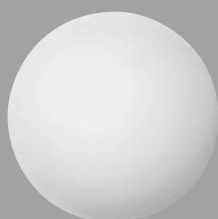

Provedení závěsů / Colour of rod pendants / Покрытие подвесов / Ausführung der Aufhängungen, Installation des suspensions par tige:

typ/type/ тип	barva/colour/цвет/ Couleur/Farbe
B	– bílý lak/white paint/белый лак/Weißlack/laqué blanc
MS	– mosaz/brass/латунь/Messing/laiton
NL	– nerez leštěná/stainless steel polished/хром/Edelstahl poliert/inox poli
NB	– nerez broušená/steel ground/матовый хром/Edelstahl geschliffen/inox émoulu

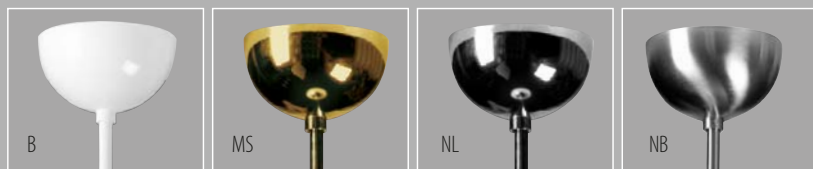

tyčový závěs / bar pendant / жесткий подвес / Stangenaufhängung / Suspension par tige

typ/type	délka/length [mm]
a1	200
a2	400
a3	600
a4	800
a5	1000

lankový závěs / wire pendant / гибкий подвес / Seilaufhängung / Suspension par fil

typ/type	délka/length [mm]
L100	1000
L200	2000

kabelový závěs / cable pendant / кабельный подвес / Kabelaufhängung / Suspension par câble

typ/type	délka/length [mm]
L100	1000



ADRIA 1



Ø 200 mm

Náhradní stínítko/spare shade/запасное стекло

Kód/code/код	Typ/Type/тип	D [mm]
20038	092	200

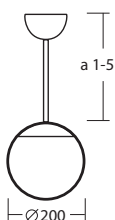

tyčový závěs/ bar pendant/ жесткий подвес/Stangenaufhängung/Suspension par tige

typ/type	délka/length [mm]
a1	200
a2	400
a3	600
a4	800
a5	1000

ADRIA 1 IP40

kód/a1 code/a1 код/a1	kód/a2 code/a2 код/a2	kód/a3 code/a3 код/a3	kód/a4 code/a4 код/a4	kód/a5 code/a5 код/a5	typ type тип	příkon input [W]	objímka socket патрон	T [h]
-----------------------------	-----------------------------	-----------------------------	-----------------------------	-----------------------------	--------------------	------------------------	-----------------------------	----------

Adria 1-B bílá/white

A								
42117	42118	42119	42120	42121	Z11/092/a. B	75	E27	

Adria 1 -MS mosaz/brass

A								
42127	42128	42129	42130	42131	Z11/092/a. MS	75	E27	

Adria 1 -NL nerez leštěná / stainless steel polished

A								
45030	45031	45032	45033	45034	Z11/092/a. NL	75	E27	

Adria 1 -NB nerez broušená / stainless steel ground

A								
45035	45036	45037	45038	45039	Z11/092/a. NB	75	E27	

ADRIA L 1



Ø 200 mm

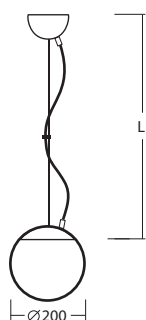

lankový závěs / wire pendant/ гибкий подвес/Seilabhängung/Suspension par fil

typ/type	délka/length [mm]
L100	1000
L200	2000

ADRIA L1 IP40

kód/L100 code/L100 код/L100	kód/L200 code/L200 код/L200	typ type тип	příkon input [W]	objímka socket патрон	T [h]
-----------------------------------	-----------------------------------	--------------------	------------------------	-----------------------------	----------

Adria L1-B bílá/white

A					
42446	42447	ZL11/092/L.. B	75	E27	

Adria L1-MS mosaz / brass

A					
42450	42451	ZL11/092/L.. MS	75	E27	

Adria L1-NL nerez leštěná / stainless polished

A					
45320	45321	ZL11/092/L.. NL	75	E27	

Adria L1-NB nerez broušená / stainless steel ground

A					
45322	45323	ZL11/092/L.. NB	75	E27	

ADRIA S 1 IP40

kód/B code/B код/В	kód/MS code/MS код/MS	kód/NL code/NL код/NL	kód/NB code/NB код/NB	typ type тип	příkon input [W]	objímka socket патрон	T [h]
53000	53001	53002	53003	ZS11/092/L100 ..	75	E27	

A

NOVINKA/NEW



Ø 200 mm

Náhradní stínítko/spare shade/запасное стекло

Kód/code/код	Typ/Type/тип	D [mm]
20038	092	200

kabelový závěs / cable pendant /
кабельный подвес / Kabelaufhängung /
Suspension par câble

typ/type	délka/length [mm]
L100	1000

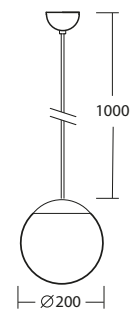

ADRIA 2



Ø 300 mm

Náhradní stínítko/spare shade/запасное стекло

Kód/code/код	Typ/Type/тип	D [mm]
20039	094	300

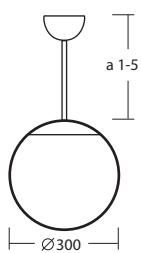

tyčový závěs/ bar pendant/ жесткий подвес/Stangenaufhängung/Suspension par tige

typ/type	délka/length [mm]
a1	200
a2	400
a3	600
a4	800
a5	1000

ADRIA 2 IP40

kód/a1 code/a1 код/a1	kód/a2 code/a2 код/a2	kód/a3 code/a3 код/a3	kód/a4 code/a4 код/a4	kód/a5 code/a5 код/a5	typ type тип	příkon input [W]	objímka socket патрон	T [h]
-----------------------------	-----------------------------	-----------------------------	-----------------------------	-----------------------------	--------------------	------------------------	-----------------------------	----------

Adria 2-B bílá/white

A								
42132	42133	42134	42135	42136	Z11/094/a. B	100	E27	
EVG								
42137	42138	42139	42140	42141	E-16Z11/094/a. B	26	G24q3	
43180	43181	43182	43183	43184	E-25Z11/094/a. B	2x18	2xG24q2	

Adria 2-MS mosaz/brass

A								
42152	42153	42154	42155	42156	Z11/094/a. MS	100	E27	
EVG								
42157	42158	42159	42160	42161	E-16Z11/094/a. MS	26	G24q3	
43185	43186	43187	43188	43189	E-25Z11/094/a. MS	2x18	2xG24q2	

Adria 2-NL nerez leštěná / stainless steel polished

A								
45040	45041	45042	45043	45044	Z11/094/a. NL	100	E27	
EVG								
45045	45046	45047	45048	45049	E-16Z11/094/a. NL	26	G24q3	
43210	43211	43212	43213	43214	E-25Z11/094/a. NL	2x18	2xG24q2	

Adria 2-NB nerez broušená / stainless steel ground

A								
45050	45051	45052	45053	45054	Z11/094/a. NB	100	E27	
EVG								
45055	45056	45057	45058	45059	E-16Z11/094/a. NB	26	G24q3	
43215	43216	43217	43218	43219	E-25Z11/094/a. NB	2x18	2xG24q2	

ADRIA L2 IP40

kód/L100 code/L100 код/L100	kód/L200 code/L200 код/L200	typ type тип	příkon input [W]	objímka socket патрон	T [h]
-----------------------------------	-----------------------------------	--------------------	------------------------	-----------------------------	----------

Adria L2-B bílá/white

A					
42452	42453	ZL11/094/L.. B	100	E27	

EVG

42454	42455	E-16ZL11/094/L.. B	26	G24q3	
43240	43241	E-25ZL11/094/L.. B	2x18	2xG24q2	

Adria L2-MS mosaz / brass

A					
42460	42461	ZL11/094/L.. MS	100	E27	

EVG

42462	42463	E-16ZL11/094/L.. MS	26	G24q3	
43242	43243	E-25ZL11/094/L.. MS	2x18	2xG24q2	

Adria L2-NL nerez leštěná / stainless polished

A					
45324	45325	ZL11/094/L.. NL	100	E27	

EVG

45326	45327	E-16ZL11/094/L.. NL	26	G24q3	
43244	43245	E-25ZL11/094/L.. NL	2x18	2xG24q2	

Adria L2-NB nerez broušená / stainless steel ground

A					
45328	45329	ZL11/094/L.. NB	100	E27	

EVG

45330	45331	E-16ZL11/094/L.. NB	26	G24q3	
43246	43247	E-25ZL11/094/L.. NB	2x18	2xG24q2	



Ø 300 mm

Náhradní stínítko/spare shade/запасное стекло

Kód/code/код	Typ/Type/тип	D [mm]
20039	094	300

Iankový závěs / wire pendant / гибкий подвес / Seilabhängung/Suspension par fil

typ/type	délka/length [mm]
L100	1000
L200	2000

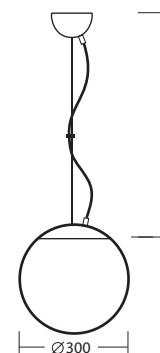

ADRIA S 2

NOVINKA/NEW



Ø 300 mm

Náhradní stínítko/spare shade/запасное стекло

Kód/code/код	Typ/Type/тип	D [mm]
20039	094	300

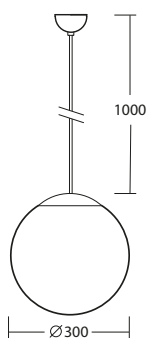
kabelový závěs /cable pendant/
кабельный подвес/Kabelaufhängung/
Suspension par câble

typ/type	délka/length [mm]
L100	1000

ADRIA S 2 IP40

kód/B code/B код/B	kód/MS code/MS код/MS	kód/NL code/NL код/NL	kód/NB code/NB код/NB	typ type тип	příkon input [W]	objímka socket патрон	T [h]
--------------------------	-----------------------------	-----------------------------	-----------------------------	--------------------	------------------------	-----------------------------	----------

A

53004	53007	53010	53013	ZS11/094/L100 ..	100	E27	
-------	-------	-------	-------	------------------	-----	-----	--

EVG

53005	53008	53011	53014	E-16ZS11/094/L100 ..	26	G24q3	
53006	53009	53012	53015	E-25ZS11/094/L100 ..	2x18	2xG24q2	

ADRIA 3 IP40

kód/a1 code/a1 код/a1	kód/a2 code/a2 код/a2	kód/a3 code/a3 код/a3	kód/a4 code/a4 код/a4	kód/a5 code/a5 код/a5	typ type тип	příkon input [W]	objímka socket патрон	T [h]
-----------------------------	-----------------------------	-----------------------------	-----------------------------	-----------------------------	--------------------	------------------------	-----------------------------	----------

Adria 3-B bílá/white

A								
42162	42163	42164	42165	42166	Z11/096/a. B	150	E27	
EVG								
42167	42168	42169	42170	42171	E-26Z11/096/a. B	2x26	2xG24q3	
45060	45061	45062	45063	45064	E-28Z11/096/a. B	2x42	2xGX24q4	
DIM								
45065	45066	45067	45068	45069	ES-26Z11/096/a. B 1-10V	2x26	2xG24q3	
45075	45076	45077	45078	45079	ES-26Z11/096/a. B DALI	2x26	2xG24q3	
NE								
45080	45081	45082	45083	45084	NKC-226Z11/13/096/a. B	2x26	2xG24q3	1,0

Adria 3-MS mosaz/brass

A								
42182	42183	42184	42185	42186	Z11/096/a. MS	150	E27	
EVG								
42187	42188	42189	42190	42191	E-26Z11/096/a. MS	2x26	2xG24q3	
45085	45086	45087	45088	45089	E-28Z11/096/a. MS	2x42	2xGX24q4	
DIM								
45090	45091	45092	45093	45094	ES-26Z11/096/a. MS 1-10V	2x26	2xG24q3	
45100	45101	45102	45103	45104	ES-26Z11/096/a. MS DALI	2x26	2xG24q3	
NE								
45105	45106	45107	45108	45109	NKC-226Z11/13/096/a. MS	2x26	2xG24q3	1,0

Adria 3-NL nerez leštěná / stainless steel polished

A								
45110	45111	45112	45113	45114	Z11/096/a. NL	150	E27	
EVG								
45115	45116	45117	45118	45119	E-26Z11/096/a. NL	2x26	2xG24q3	
45120	45121	45122	45123	45124	E-28Z11/096/a. NL	2x42	2xGX24q4	
DIM								
45125	45126	45127	45128	45129	ES-26Z11/096/a. NL 1-10V	2x26	2xG24q3	
45135	45136	45137	45138	45139	ES-26Z11/096/a. NL DALI	2x26	2xG24q3	
NE								
45140	45141	45142	45143	45144	NKC-226Z11/13/096/a. NL	2x26	2xG24q3	1,0

Adria 3-NB nerez broušená / stainless steel ground

A								
45145	45146	45147	45148	45149	Z11/096/a. NB	150	E27	
EVG								
45150	45151	45152	45153	45154	E-26Z11/096/a. NB	2x26	2xG24q3	
45155	45156	45157	45158	45159	E-28Z11/096/a. NB	2x42	2xGX24q4	
DIM								
45160	45161	45162	45163	45164	ES-26Z11/096/a. NB 1-10V	2x26	2xG24q3	
45170	45171	45172	45173	45174	ES-26Z11/096/a. NB DALI	2x26	2xG24q3	
NE								
45175	45176	45177	45178	45179	NKC-226Z11/13/096/a. NB	2x26	2xG24q3	1,0

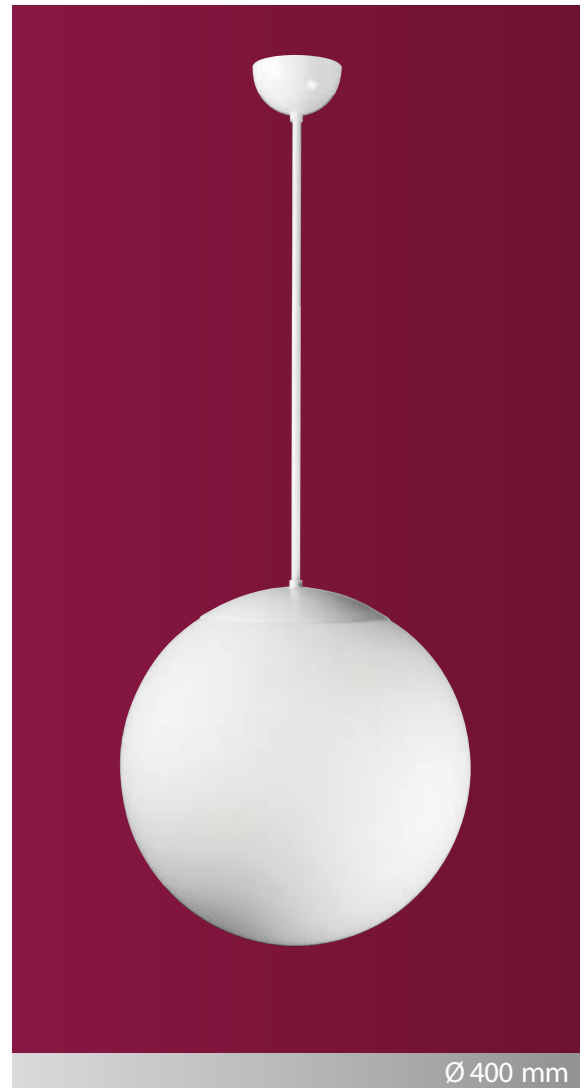

Ø 400 mm

Náhradní stínítko/spare shade/запасное стекло

Kód/code/код	Typ/Type/тип	D [mm]
20040	096	400

tyčový závěs / bar pendant / жесткий подвес / Stangenaufhängung / Suspension par tige

typ/type	délka/length [mm]
a1	200
a2	400
a3	600
a4	800
a5	1000

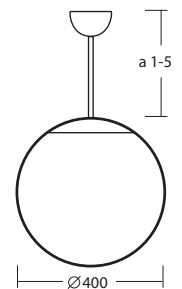

ADRIA L 3



Ø 400 mm

Náhradní stínítka/spare shade/запасное стекло

Kód/code/код	Typ/Type/тип	D [mm]
20040	096	400

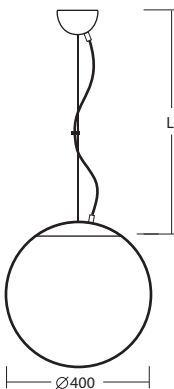

Iankový závěs / wire pendant / гибкий подвес / Seilaufhängung/Suspension par fil

typ/type	délka/length [mm]
L100	1000
L200	2000

ADRIA L 3 IP40

kód/L100 code/L100 код/L100	kód/L200 code/L200 код/L200	typ type тип	přikon input [W]	objímka socket патрон	T [h]
-----------------------------------	-----------------------------------	--------------------	------------------------	-----------------------------	----------

Adria L3-B bílá/white

A					
42464	42465	ZL11/096/L.. B	150	E27	

EVG					
42466	42467	E-26ZL11/096/L.. B	2x26	2xG24q3	
45332	45333	E-28ZL11/096/L.. B	2x42	2xGX24q4	

DIM					
45334	45335	ES-26ZL11/096/L.. B 1-10V	2x26	2xG24q3	
45338	45339	ES-26ZL11/096/L.. B DALI	2x26	2xG24q3	

NE					
45340	45341	NKC-226ZL/13/096/L.. B	2x26	2xG24q3	1,0

Adria L3-MS mosaz / brass

A					
42472	42473	ZL11/096/L.. MS	150	E27	

EVG					
42474	42475	E-26ZL11/096/L.. MS	2x26	2xG24q3	
45342	45343	E-28ZL11/096/L.. MS	2x42	2xGX24q4	

DIM					
45344	45345	ES-26ZL11/096/L.. MS 1-10V	2x26	2xG24q3	
45348	45349	ES-26ZL11/096/L.. MS DALI	2x26	2xG24q3	

NE					
45350	45351	NKC-226ZL/13/096/L.. MS	2x26	2xG24q3	1,0

Adria L3-NL nerez leštěná / stainless polished

A					
45352	45353	ZL11/096/L.. NL	150	E27	

EVG					
45354	45355	E-26ZL11/096/L.. NL	2x26	2xG24q3	
45356	45357	E-28ZL11/096/L.. NL	2x42	2xGX24q4	

DIM					
45358	45359	ES-26ZL11/096/L.. NL 1-10V	2x26	2xG24q3	
45362	45363	ES-26ZL11/096/L.. NL DALI	2x26	2xG24q3	

NE					
45364	45365	NKC-226ZL/13/096/L.. NL	2x26	2xG24q3	1,0

Adria L3-NB nerez broušená / stainless steel ground

A					
45366	45367	ZL11/096/L.. NB	150	E27	

EVG					
45368	45369	E-26ZL11/096/L.. NB	2x26	2xG24q3	
45370	45371	E-28ZL11/096/L.. NB	2x42	2xGX24q4	

DIM					
45372	45373	ES-26ZL11/096/L.. NB 1-10V	2x26	2xG24q3	
45376	45377	ES-26ZL11/096/L.. NB DALI	2x26	2xG24q3	

NE					
45378	45379	NKC-226ZL/13/096/L.. NB	2x26	2xG24q3	1,0

ADRIA S 3 IP40

kód/B code/B код/В	kód/MS code/MS код/MS	kód/NL code/NL код/NL	kód/NB code/NB код/NB	typ type тип	příkon input [W]	objímka socket патрон	T [h]
A							
53016	53022	53028	53034	ZS11/096/L100 ..	150	E27	
EVG							
53017	53023	53029	53035	E-26ZS11/096/L100 ..	2x26	2xG24q3	
53018	53024	53030	53036	E-28ZS11/096/L100 ..	2x42	2xGX24q4	
DIM							
53019	53025	53031	53037	ES-26ZS11/096/L100 .. 1-10V	2x26	2xG24q3	
53020	53026	53032	53038	ES-26ZS11/096/L100 .. DALI	2x26	2xG24q3	
NE							
53021	53027	53033	53039	NKC-226ZS/13/096/L100 ..	2x26	2xG24q3	1,0

NOVINKA/NEW



Ø 400 mm

Náhradní stínítko/spare shade/запасное стекло

Kód/code/код	Typ/Type/тип	D [mm]
20040	096	400

kabelový závěs / cable pendant /
кабельный подвес / Kabelaufhängung /
Suspension par câble

typ/type	délka/length [mm]
L100	1000

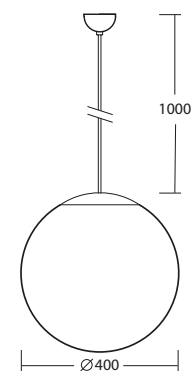

ADRIA 4



Náhradní stínítko/spare shade/запасное стекло

Kód/code/код	Typ/Type/тип	D [mm]
20041	098	500

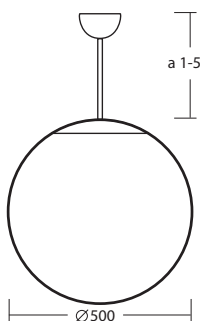

tyčový závěs/ bar pendant/ жесткий подвес /Stangenaufhängung/Suspension par tige

typ/type	délka/length [mm]
a1	200
a2	400
a3	600
a4	800
a5	1000

ADRIA 4 IP40

kód/a1 code/a1 код/a1	kód/a2 code/a2 код/a2	kód/a3 code/a3 код/a3	kód/a4 code/a4 код/a4	kód/a5 code/a5 код/a5	typ type тип	příkon input [W]	objímka socket патрон	T [h]
-----------------------------	-----------------------------	-----------------------------	-----------------------------	-----------------------------	--------------------	------------------------	-----------------------------	----------

Adria 4-B bílá/white

A								
42192	42193	42194	42195	42196	Z11/098/a. B	150	E27	
EVG								
44210	44211	44212	44213	44214	E-26Z11/098/a. B 32W	2x32	2xGX24q3	
42355	42356	42357	42358	42359	E-46Z11/098/a. B	4x26	4xG24q3	
45185	45186	45187	45188	45189	E-38Z11/098/a. B	3x42	3xGX24q4	
DIM								
45190	45191	45192	45193	45194	ES-46Z11/098/a. B 1-10V	4x26	4xG24q3	
45200	45201	45202	45203	45204	ES-46Z11/098/a. B DALI	4x26	4xG24q3	
NE								
45205	45206	45207	45208	45209	NKC-232Z11/16/098/a. B	2x32	2xGX24q3	1,0

Adria 4-MS mosaz/brass

A								
42212	42213	42214	42215	42216	Z11/098/a. MS	150	E27	
EVG								
44215	44216	44217	44218	44219	E-26Z11/098/a. MS 32W	2x32	2xGX24q3	
42375	42376	42377	42378	42379	E-46Z11/098/a. MS	4x26	4xG24q3	
45215	45216	45217	45218	45219	E-38Z11/098/a. MS	3x42	3xGX24q4	
DIM								
45220	45221	45222	45223	45224	ES-46Z11/098/a. MS 1-10V	4x26	4xG24q3	
45230	45231	45232	45233	45234	ES-46Z11/098/a. MS DALI	4x26	4xG24q3	
NE								
45235	45236	45237	45238	45239	NKC-232Z11/16/098/a. MS	2x32	2xGX24q3	1,0

Adria4-NL nerez leštěná / stainless steel polished

A								
45240	45241	45242	45243	45244	Z11/098/a. NL	150	E27	
EVG								
44220	44221	44222	44223	44224	E-26Z11/098/a. NL 32W	2x32	2xGX24q3	
45250	45251	45252	45253	45254	E-46Z11/098/a. NL	4x26	4xG24q3	
45255	45256	45257	45258	45259	E-38Z11/098/a. NL	3x42	3xGX24q4	
DIM								
45260	45261	45262	45263	45264	ES-46Z11/098/a. NL 1-10V	4x26	4xG24q3	
45270	45271	45272	45273	45274	ES-46Z11/098/a. NL DALI	4x26	4xG24q3	
NE								
45275	45276	45277	45278	45279	NKC-232Z11/16/098/a. NL	2x32	2xGX24q3	1,0

Adria 4-NB nerez broušená / stainless steel ground

A								
45280	45281	45282	45283	45284	Z11/098/a. NB	150	E27	
EVG								
44225	44226	44227	44228	44229	E-26Z11/098/a. NB 32W	2x32	2xGX24q3	
45290	45291	45292	45293	45294	E-46Z11/098/a. NB	4x26	4xG24q3	
45295	45296	45297	45298	45299	E-38Z11/098/a. NB	3x42	3xGX24q4	
DIM								
45300	45301	45302	45303	45304	ES-46Z11/098/a. NB 1-10V	4x26	4xG24q3	
45310	45311	45312	45313	45314	ES-46Z11/098/a. NB DALI	4x26	4xG24q3	
NE								
45315	45316	45317	45318	45319	NKC-232Z11/16/098/a. NB	2x32	2xGX24q3	1,0

ADRIA L 4 IP40

kód/L100 code/L100 код/L100	kód/L200 code/L200 код/L200	typ type тип	příkon input [W]	objímka socket патрон	T [h]
-----------------------------------	-----------------------------------	--------------------	------------------------	-----------------------------	----------

Adria L 4-B bílá/white

A					
42476	42477	ZL11/098/L.. B	150	E27	

EVG

44230	44231	E-26ZL11/098/L.. B 32W	2x32	2xGX24q3	
42482	42483	E-46ZL11/098/L.. B	4x26	4xG24q3	
45382	45383	E-38ZL11/098/L.. B	3x42	3xGX24q4	

DIM

45384	45385	ES-46ZL11/098/L.. B 1-10V	4x26	4xG24q3	
45388	45389	ES-46ZL11/098/L.. B DALI	4x26	4xG24q3	

NE

45390	45391	NKC-232ZL/16/098/L.. B	2x32	2xGX24q3	1,0
-------	-------	------------------------	------	----------	-----

Adria L4-MS mosaz / brass

A					
42492	42493	ZL11/098/L.. MS	150	E27	

EVG

44232	44233	E-26ZL11/098/L.. MS 32W	2x32	2xGX24q3	
42498	42499	E-46ZL11/098/L.. MS	4x26	4xG24q3	
45394	45395	E-38ZL11/098/L.. MS	3x42	3xGX24q4	

DIM

45396	45397	ES-46ZL11/098/L.. MS 1-10V	4x26	4xG24q3	
45400	45401	ES-46ZL11/098/L.. MS DALI	4x26	4xG24q3	

NE

45402	45403	NKC-232ZL/16/098/L.. MS	2x32	2xGX24q3	1,0
-------	-------	-------------------------	------	----------	-----

Adria L4-NL nerez leštěná / stainless polished

A					
45404	45405	ZL11/098/L.. NL	150	E27	

EVG

44234	44235	E-26ZL11/098/L.. NL 32W	2x32	2xGX24q3	
45408	45409	E-46ZL11/098/L.. NL	4x26	4xG24q3	
45410	45411	E-38ZL11/098/L.. NL	3x42	3xGX24q4	

DIM

45412	45413	ES-46ZL11/098/L.. NL 1-10V	4x26	4xG24q3	
45416	45417	ES-46ZL11/098/L.. NL DALI	4x26	4xG24q3	

NE

45418	45419	NKC-232ZL/16/098/L.. NL	2x32	2xGX24q3	1,0
-------	-------	-------------------------	------	----------	-----

Adria L4-NB nerez broušená / stainless steel ground

A					
45420	45421	ZL11/098/L.. NB	150	E27	

EVG

44236	44237	E-26ZL11/098/L.. NB 32W	2x32	2xGX24q3	
45424	45425	E-46ZL11/098/L.. NB	4x26	4xG24q3	
45426	45427	E-38ZL11/098/L.. NB	3x42	3xGX24q4	

DIM

45428	45429	ES-46ZL11/098/L.. NB 1-10V	4x26	4xG24q3	
45432	45433	ES-46ZL11/098/L.. NB DALI	4x26	4xG24q3	

NE

45434	45435	NKC-232ZL/16/098/L.. NB	2x32	2xGX24q3	1,0
-------	-------	-------------------------	------	----------	-----



Ø 500 mm

Náhradní stínítko/spare shade/запасное стекло

Kód/code/код	Typ/Type/тип	D [mm]
20041	098	500

lankový závěs / wire pendant / гибкий подвес / Seilaufhängung/Suspension par fil

typ/type	délka/length [mm]
L100	1000
L200	2000

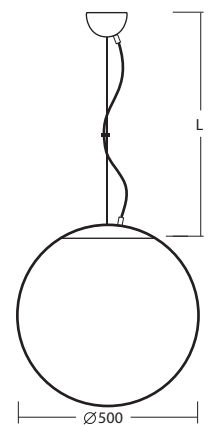

ADRIA S4

NOVINKA/NEW



Ø 500 mm

Náhradní stínítko/spare shade/запасное стекло

Kód/code/код	Typ/Type/тип	D [mm]
20041	098	500

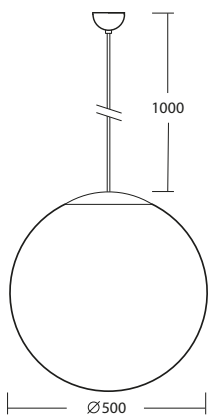
kabelový závěs /cable pendant/
кабельный подвес/Kabelaufhängung/
Suspension par câble

typ/type	délka/length [mm]
L100	1000

ADRIA S 4 IP40

kód/B code/B код/B	kód/MS code/MS код/MS	kód/NL code/NL код/NL	kód/NB code/NB код/NB	typ type тип	příkon input [W]	objímka socket патрон	T [h]
A							
53040	53046	53052	53058	ZS11/098/L100 ..	150	E27	
EVG							
53041	53047	53053	53059	E-26ZS11/098/L100 ..32W	2x32	2xGX24q3	
53042	53048	53054	53060	E-46ZS11/098/L100 .	4x26.	4xG24q3	
DIM							
53043	53049	53055	53061	ES-46ZS11/098/L100 .. 1-10V	4x26	4xG24q3	
53044	53050	53056	53062	ES-46ZS11/098/L100 .. DALI	4x26	4xG24q3	
NE							
53045	53051	53057	53063	NKC-232ZS/16/098/L100 ..	2x32	2xGX24q3	1,0

ADRIA 5 IP40

kód/a1 code/a1 код/a1	kód/a2 code/a2 код/a2	kód/a3 code/a3 код/a3	kód/a4 code/a4 код/a4	kód/a5 code/a5 код/a5	typ type тип	přikon input [W]	objímka socket патрон	T [h]
-----------------------------	-----------------------------	-----------------------------	-----------------------------	-----------------------------	--------------------	------------------------	-----------------------------	----------

Adria 5-B bílá/white

A								
45700	45701	45702	45703	45704	Z11/099/a. B	150	E27	
45705	45706	45707	45708	45709	Z11/3/099/a. B	3x60	3xE27	

EVG

45710	45711	45712	45713	45714	E-38Z11/099/a. B	3x42	3xGX24q4	
45715	45716	45717	45718	45719	E-48Z11/099/a. B	4x42	4xGX24q4	

DIM

45720	45721	45722	45723	45724	ES-48Z11/099/a. B 1-10V	4x42	4xGX24q4	
45725	45726	45727	45728	45729	ES-48Z11/099/a. B DALI	4x42	4xGX24q4	

Adria 5-MS mosaz/brass

A								
45730	45731	45732	45733	45734	Z11/099/a. MS	150	E27	
45735	45736	45737	45738	45739	Z11/3/099/a. MS	3x60	3xE27	

EVG

45740	45741	45742	45743	45744	E-38Z11/099/a. MS	3x42	3xGX24q4	
45745	45746	45747	45748	45749	E-48Z11/099/a. MS	4x42	4xGX24q4	

DIM

45750	45751	45752	45753	45754	ES-48Z11/099/a. MS 1-10V	4x42	4xGX24q4	
45755	45756	45757	45758	45759	ES-48Z11/099/a. MS DALI	4x42	4xGX24q4	

Adria 5-NL nerez leštěná / stainless steel polished

A								
45760	45761	45762	45763	45764	Z11/099/a. NL	150	E27	
45765	45766	45767	45768	45769	Z11/3/099/a. NL	3x60	3xE27	

EVG

45770	45771	45772	45773	45774	E-38Z11/099/a. NL	3x42	3xGX24q4	
45775	45776	45777	45778	45779	E-48Z11/099/a. NL	4x42	4xGX24q4	

DIM

45780	45781	45782	45783	45784	ES-48Z11/099/a. NL 1-10V	4x42	4xGX24q4	
45785	45786	45787	45788	45789	ES-48Z11/099/a. NL DALI	4x42	4xGX24q4	

Adria 5-NB nerez broušená / stainless steel ground

A								
45790	45791	45792	45793	45794	Z11/099/a. NB	150	E27	
45795	45796	45797	45798	45799	Z11/3/099/a. NB	3x60	3xE27	

EVG

45800	45801	45802	45803	45804	E-38Z11/099/a. NB	3x42	3xGX24q4	
45805	45806	45807	45808	45809	E-48Z11/099/a. NB	4x42	4xGX24q4	

DIM

45810	45811	45812	45813	45814	ES-48Z11/099/a. NB 1-10V	4x42	4xGX24q4	
45815	45816	45817	45818	45819	ES-48Z11/099/a. NB DALI	4x42	4xGX24q4	



Ø 600 mm

Náhradní stínítko/spare shade/запасное стекло

Kód/code/код	Typ/Type/тип	D [mm]
20076	099	600

tyčový závěs / bar pendant / жесткий подвес / Stangenaufhängung / Suspension par tige

typ/type	délka/length [mm]
a1	200
a2	400
a3	600
a4	800
a5	1000

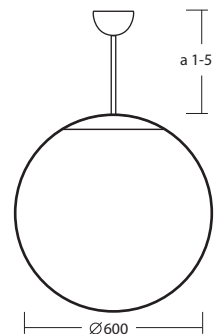

ADRIA L 5



Ø 600 mm

Náhradní stínítko/spare shade/запасное стекло

Kód/code/код	Typ/Type/тип	D [mm]
20076	099	600

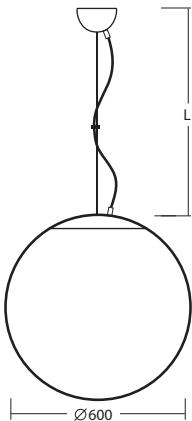

lankový závěs / wire pendant / гибкий подвес / Seilabhängung/Suspension par fil

typ/type	délka/length [mm]
L 100	1000
L 200	2000

ADRIA L 5 IP40

kód/L100 code/L100 код/L100	kód/L200 code/L200 код/L200	typ type тип	příkon input [W]	objímka socket патрон	T [h]
-----------------------------------	-----------------------------------	--------------------	------------------------	-----------------------------	----------

Adria L5-B bílá /white

A					
45830	45831	ZL11/099/L.. B	150	E27	
45832	45833	ZL11/3/099/L.. B	3x60	3xE27	

EVG

45834	45835	E-38ZL11/099/L.. B	3x42	3xGX24q4	
45836	45837	E-48ZL11/099/L.. B	4x42	4xGX24q4	

DIM

45838	45839	ES-48ZL11/099/L.. B 1-10V	4x42	4xGX24q4	
45840	45841	ES-48ZL11/099/L.. B DALI	4x42	4xGX24q4	

Adria L5-MS mosaz / brass

A					
45842	45843	ZL11/099/L.. MS	150	E27	
45844	45845	ZL11/3/099/L.. MS	3x60	3xE27	

EVG

45846	45847	E-38ZL11/099/L.. MS	3x42	3xGX24q4	
45848	45849	E-48ZL11/099/L.. MS	4x42	4xGX24q4	

DIM

45850	45851	ES-48ZL11/099/L.. MS1-10V	4x42	4xGX24q4	
45852	45853	ES-48ZL11/099/L.. MS DALI	4x42	4xGX24q4	

Adria L5-NL nerez leštěná / stainless polished

A					
45854	45855	ZL11/099/L.. NL	150	E27	
45856	45857	ZL11/3/099/L.. NL	3x60	3xE27	

EVG

45858	45859	E-38ZL11/099/L.. NL	3x42	3xGX24q4	
45860	45861	E-48ZL11/099/L.. NL	4x42	4xGX24q4	

DIM

45862	45863	ES-48ZL11/099/L.. NL 1-10V	4x42	4xGX24q4	
45864	45865	ES-48ZL11/099/L.. NL DALI	4x42	4xGX24q4	

Adria L5-NB nerez broušená / stainless steel ground

A					
45866	45867	ZL11/099/L.. NB	150	E27	
42868	45869	ZL11/3/099/L.. NB	3x60	3xE27	

EVG

45870	45871	E-38ZL11/099/L.. NB	3x42	3xGX24q4	
45872	45873	E-48ZL11/099/L.. NB	4x42	4xGX24q4	

DIM

45874	45875	ES-48ZL11/099/L.. NB 1-10V	4x42	4xGX24q4	
45876	45877	ES-48ZL11/099/L.. NB DALI	4x42	4xGX24q4	

ADRIA S 5 IP40

kód/B code/B код/В	kód/MS code/MS код/MS	kód/NL code/NL код/NL	kód/NB code/NB код/NB	typ type тип	příkon input [W]	objímka socket патрон	T [h]
A							
53064	53070	53076	53082	ZS11/099/L100 ..	150	E27	
53065	53071	53077	53083	ZS11/3/099/L100 ..	3x60	3xE27	
EVG							
53066	53072	53078	53084	E-38ZS11/099/L100 ..	3x42	3xGX24q4	
53067	53073	53079	53085	E-48ZS11/099/L100 ..	4x42	4xGX24q4	
DIM							
53068	53074	53080	53086	ES-48ZS11/099/L100 .. 1-10V	4x42	4xGX24q4	
53069	53075	53081	53087	ES-48ZS11/099/L100 .. DALI	4x42	4xGX24q4	

NOVINKA/NEW



Ø 600 mm

Náhradní stínítko/spare shade/запасное стекло

Kód/code/код	Typ/Type/тип	D [mm]
20076	099	600

kabelový závěs /cable pendant/
кабельный подвес/Kabelaufhängung/
Suspension par câble

typ/type	délka/length [mm]
L100	1000

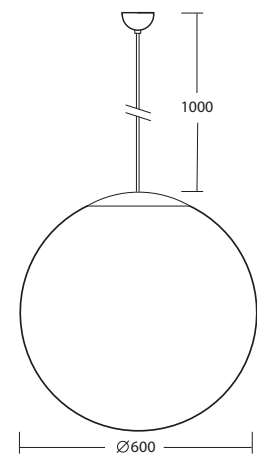



Náhradní stínítka/spare shade/запасное стекло

Kód/code/код	Typ/Type/тип	a x b / [mm]
20048	095	350x430

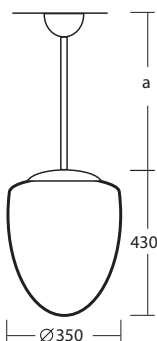

tyčový závěs/ bar pendant/ жесткий подвес/ Stangenabhängung/Suspension par tige

typ/type	délka/length [mm]
a1	200
a2	400
a3	600
a4	800
a5	1000

ASTRA IP40

kód/a1 code/a1 код/a1	kód/a2 code/a2 код/a2	kód/a3 code/a3 код/a3	kód/a4 code/a4 код/a4	kód/a5 code/a5 код/a5	typ type тип	příkon input [W]	objímka socket патрон	T [h]
Astra L- B bílá/white								
42230	42231	42232	42233	42234	Z11/095/a. B	150	E27	
EVG								
42235	42236	42237	42238	42239	E-26Z11/095/a. B	2x26	2xG24q3	
DIM								
45436	45437	45438	45439	45440	ES-26Z11/095/a. B 1-10V	2x26	2xG24q3	
45446	45447	45448	45449	45450	ES-26Z11/095/a. B DALI	2x26	2xG24q3	
NE								
45451	45452	45453	45454	45455	NKC-226Z11/13/095/a. B	2x26	2xG24q3	1,0
Astra - MS mosaz/brass								
42260	42261	42262	42263	42264	Z11/095/a. MS	150	E27	
EVG								
42265	42266	42267	42268	42269	E-26Z11/095/a. MS	2x26	2xG24q3	
DIM								
45456	45457	45458	45459	45460	ES-26Z11/095/a. MS 1-10V	2x26	2xG24q3	
45466	45467	45468	45469	45470	ES-26Z11/095/a. MS DALI	2x26	2xG24q3	
NE								
45471	45472	45473	45474	45475	NKC-226Z11/13/095/a. MS	2x26	2xG24q3	1,0
Astra - NL nerez leštěná / stainless steel polished								
45476	45477	45478	45479	45480	Z11/095/a. NL	150	E27	
EVG								
45481	45482	45483	45484	45485	E-26Z11/095/a. NL	2x26	2xG24q3	
DIM								
45486	45487	45488	45489	45490	ES-26Z11/095/a. NL 1-10V	2x26	2xG24q3	
45496	45497	45498	45499	45500	ES-26Z11/095/a. NL DALI	2x26	2xG24q3	
NE								
45501	45502	45503	45504	45505	NKC-226Z11/13/095/a. NL	2x26	2xG24q3	1,0
Adria - NB nerez broušená / stainless steel ground								
45506	45507	45508	45509	45510	Z11/095/a. NB	150	E27	
EVG								
45511	45512	45513	45514	45515	E-26Z11/095/a. NB	2x26	2xG24q3	
DIM								
45516	45517	45518	45519	45520	ES-26Z11/095/a. NB 1-10V	2x26	2xG24q3	
45550	45551	45552	45553	45554	ES-26Z11/095/a. NB DALI	2x26	2xG24q3	
NE								
45555	45556	45557	45558	45559	NKC-226Z11/13/095/a. NB	2x26	2xG24q3	1,0

ASTRA L IP40					
kód/L100 code/L100 код/L100	kód/L200 code/L200 код/L200	typ type тип	příkon input [W]	objímka socket патрон	T [h]
Astra L-B bílá/white					
45530	45531	ZL11/095/L.. B	150	E27	
EVG					
45532	45533	E-26ZL11/095/L.. B	2x26	2xG24q3	
DIM					
45560	45561	ES-26ZL11/095/L.. B 1-10V	2x26	2xG24q3	
45564	45565	ES-26ZL11/095/L.. B DALI	2x26	2xG24q3	
NE					
45566	45567	NKC-226ZL/13/095/L.. B	2x26	2xG24q3	1,0
Astra L-MS mosaz/brass					
45542	45543	ZL11/095/L.. MS	150	E27	
EVG					
45544	45545	E-26ZL11/095/L.. MS	2x26	2xG24q3	
DIM					
45568	45569	ES-26ZL11/095/L.. MS 1-10V	2x26	2xG24q3	
45572	45573	ES-26ZL11/095/L.. MS DALI	2x26	2xG24q3	
NE					
45574	45575	NKC-226ZL/13/095/L.. MS	2x26	2xG24q3	1,0
Astra L-NL nerez leštěná / stainless polished					
45576	45577	ZL11/095/L.. NL	150	E27	
EVG					
45578	45579	E-26ZL11/095/L.. NL	2x26	2xG24q3	
DIM					
45580	45581	ES-26ZL11/095/L.. NL 1-10V	2x26	2xG24q3	
45584	45585	ES-26ZL11/095/L.. NL DALI	2x26	2xG24q3	
NE					
45586	45587	NKC-226ZL/13/095/L.. NL	2x26	2xG24q3	1,0
Astra L-NB nerez broušená / stainless steel ground					
45588	45589	ZL11/095/L.. NB	150	E27	
EVG					
45590	45591	E-26ZL11/095/L.. NB	2x26	2xG24q3	
DIM					
45592	45593	ES-26ZL11/095/L.. NB 1-10V	2x26	2xG24q3	
45596	45597	ES-26ZL11/095/L.. NB DALI	2x26	2xG24q3	
NE					
45598	45599	NKC-226ZL/13/095/L.. NB	2x26	2xG24q3	1,0



Náhradní stínítko/spare shade/запасное стекло

Kód/code/код	Typ/Type/тип	a x b / [mm]
20048	095	350x430

lankový závěs / wire pendant / гибкий подвес / Seilaufhängung/Suspension par fil

typ/type	délka/length [mm]
L100	1000
L200	2000

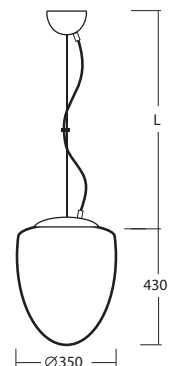

ASTRA S

NOVINKA/NEW



Ø 350 mm

Náhradní stínítko/spare shade/запасное стекло

Kód/code/код	Typ/Type/тип	a x b/ [mm]
20048	095	350x430

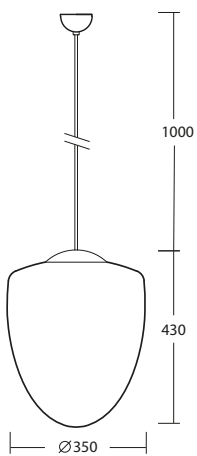
kabelový závěs / cable pendant /
кабельный подвес / Kabelaufhängung /
Suspension par câble

typ/type	délka/length [mm]
L100	1000

ASTRA S IP40

kód/B code/B код/B	kód/MS code/MS код/MS	kód/NL code/NL код/NL	kód/NB code/NB код/NB	typ type тип	přikon input [W]	objímka socket патрон	T [h]
A							
49208	49209	49210	49211	ZS11/095/L100 ..	150	E27	
EVG							
49212	49213	49214	49215	E-26ZS11/095/L100 ..	2x26	2xG24q3	
DIM							
49216	49217	49218	49219	ES-26ZS11/095L100 .. 1-10V	2x26	2xG24q3	
49220	49221	49222	49223	ES-26ZS11/095/L100 .. DALI	2x26	2xG24q3	
NE							
49224	49225	49226	49227	NKC-226ZS/13/095/L100 ..	2x26	2xG24q3	1,0



DANAË 1,2



POPIS SVÍTIDEL

DANAË 1 – Svítidlo se skládá ze dvou osvětlovacích částí (2 skleněná stínítka) a z kabelového závěsu, obě části se spínají samostatně:

- | | |
|--------------------------|--|
| 1. hlavní světelný zdroj | - zářivkový zdroj |
| 2. doplňkový zdroj | - LED moduly |
| Držení stínítka | - ocelový držák pro otvor 210mm |
| Závěs | - kabelový - bílý lak a bílý závěsný kabel |

DANAË 2 – Svítidlo tvoří skleněné stínítko a třílankový závěs

- | | |
|-----------------|---|
| Držení stínítka | - sklápovací držáky |
| Závěs | - třílankový: B – bílý lak a transparentní šňůra
MS – mosaz a transparentní šňůra
NL – nerez leštěná a transparentní šňůra
NB – nerez broušená a transparentní šňůra |

DESCRIPTION OF THE LIGHTING FITTINGS

DANAË 1 – The lighting fittings consist of two illuminating parts (2 glass shades) and the cable pendant, Both parts are fastened separately:

- | | |
|-------------------------|---|
| 1. Main lighting source | - fluorescent source |
| 2. Additional source | - LED modules |
| Shade attachment | - steel holder for the hole of 210 mm |
| Pendant | - cable – white paint and white pendant cable |

DANAË 2 – the lighting fitting consist of the glass shade and 3-wires pendant

- | | |
|------------------|---|
| Shade attachment | - with folding two-step clamp holders |
| Pendant | - 3 wires B – white paint and transparent cord
MS – brass and transparent cord
NL – stainless steel polished and transparent cord
NB – stainless steel ground and transparent cord |

ОПИСАНИЕ СВЕТИЛЬНИКОВ

DANAË 1 – Светильник состоит из двух освещенных частей (2 стеклянных светорассеивателя) и кабельного подвеса, обе части включаются самостоятельно:

- | | |
|-----------------------------------|---|
| 1. основной источник света | - люминесцентная лампа |
| 2. дополнительные источники света | - светодиодные модули |
| Крепление рассеивателя | - металлическое крепление для отверстия 210мм |
| Подвес | - кабельный: белый лак и белый подвесной кабель |

DANAË 2 – Светильник состоит из стеклянного светорассеивателя и подвеса состоящего из трех стальных тросов

- | | |
|------------------------|---|
| Крепление рассеивателя | - фиксаторы - защелки |
| Подвес | - три троса: B – белый лак и прозрачный кабель
MS – латунь и прозрачный кабель
NL – хром и прозрачный кабель
NB – матовый хром и прозрачный кабель |

BESCHREIBUNG DER LEUCHTEN

DANAË 1 – Die Leuchte besteht aus zwei Teilen (2 Glasabdeckungen) und der Kabelaufhängung, beide Teile werden selbständig geschaltet:

- | | |
|-----------------------------|--|
| 1. Hauptlichtquelle | - Leuchtstofflampe |
| 2. Zusatzlichtquelle | - LED Module |
| Halterung der Abdeckscheibe | - Stahlhalter für eine Öffnung mit 210mm |
| Aufhängung | - Kabelaufhängung – Weißlack und weißes Aufhängungskabel |

DANAË 2 – Die Leuchte besteht aus der Glasabdeckung und der Dreifach-Seilaufhängung

- | | |
|-----------------------------|---|
| Halterung der Abdeckscheibe | - klappbare Halterungen |
| Aufhängung | - Dreifach-Seilaufhängung: B – Weißlack und transparente Schnur
MS – Messing und transparente Schnur
NL – polierter Edelstahl und transparente Schnur
NB – geschliffener Edelstahl und transparente Schnur |

DESCRIPTION DES LUMINAIRES

DANAË 1 – Le luminaire est composé de deux parties d'éclairage (2 abat-jours en verre) et une suspension par câble, les deux parties peuvent être activées séparément et indépendamment:

- | | |
|---------------------------------|---|
| 1. source de lumière principale | - source fluorescente |
| 2. source supplémentaire | - modules LED |
| fixation du luminaire | - support en acier pour une ouverture de 210 mm |
| Suspension - câble | - laqué blanc et câble de suspension blanc |

DANAË 2 – Le luminaire se compose d'un abat-jour en verre et d'une suspension par câble composée de trois fils

- | | |
|------------------------------------|--|
| Base de l'abat-jour – support clip | |
| Suspension | - câble composé de trois fils: B – laqué blanc et cordon transparent
MS – laiton et de cordon transparent
NL – Cordon en acier inox poli et transparent
NB – Cordon en acier inox affilé et transparent |

DANAЕ 1

DANAЕ 1 IP40

Kód code код	typ type тип	příkon input [W]	lm LED	objímka socket патрон
--------------------	--------------------	------------------------	--------	-----------------------------

A				
53600+	ZS11/5L01/452/L100 2/1 3000	40/9	630	E27
53100+	ZS11/5L01/452/L100 2/1 4000	40/9	710	E27

EVG				
53601+	E-26ZS11/5L01/452/L100 2/1 3000	2x26/9	630	2xG24q3
53101+	E-26ZS11/5L01/452/L100 2/1 4000	2x26/9	710	2xG24q3

+ - 2/1 – dvouokruhové ovládání světelných zdrojů / two electric circuits / двухконтурное управление лампами / Lichtquellensteuerung durch 2 Schaltkreise / Commande a 2 circuits électriques



Ø 350 mm

Náhradní stínítka/spare shade/запасное стекло

Kód/code/код	Typ/Type/тип	D [mm]
20088	452-1	265
20089	452-2	350

DANAЕ 2

DANAЕ 2 IP40

kód/B code/B код/B	kód/MS code/MS код/MS	kód/NL code/NL код/NL	kód/NB code/NB код/NB	typ type тип	příkon input [W]	objímka socket патрон
--------------------------	-----------------------------	-----------------------------	-----------------------------	--------------------	------------------------	-----------------------------

A						
53102	53103	53104	53105	ZT11/472/L100 ..	75	E27

EVG						
53106	53107	53108	53109	E-26ZT11/472/L100 .. 32W	2x32	2xGX24q3

DANAЕ 1

kabelový závěs / cable pendant /
кабельный подвес / Kabelaufhängung /
Suspension par câble

typ/type	délka/length [mm]
L100	1000

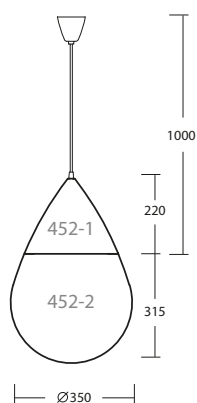

DANAЕ 2

lankový závěs / wire pendant / гибкий
подвес / Seilabhängung / Suspension
par fil

typ/type	délka/length [mm]
L100	1000

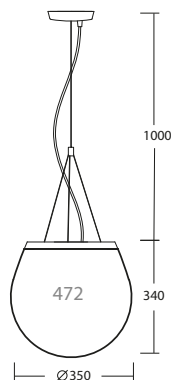

Ø 350 mm

Náhradní stínítka/spare shade/запасное стекло

Kód/code/код	Typ/Type/тип	D [mm]
20063	472	350

DANTE 1,2



POPIS SVÍTIDEL

DANTE 1 – Svítidlo se skládá ze dvou osvětlovacích částí (2 skleněná stínítka) a z kabelového závěsu, obě části se spínají samostatně:

- | | |
|--------------------------|--|
| 1. hlavní světelný zdroj | - zářivkový zdroj |
| 2. doplňkový zdroj | - LED moduly |
| Držení stínítka | - ocelový držák pro otvor 110 mm |
| Závěs | - kabelový – bílý lak a bílý závěsný kabel |

DANTE 2 – Svítidlo tvoří skleněné stínítko a tyčový závěs .

- | | |
|-----------------|--|
| Držení stínítka | - ocelový držák pro otvor 110mm |
| Závěs | - tyčový: B - bílý lak
S - stříbrný lak |

DESCRIPTION OF THE LIGHTING FITTINGS

DANTE 1 – Lighting fittings consist of the two illuminating parts (2 glass shades) and the cable pendant, Both parts fasten separately:

- | | |
|-------------------------|---|
| 1. Main lighting source | - fluorescent lamps |
| 2. Additional source | - LED modules |
| Shade attachment | - steel holder for the hole 110 mm |
| Pendant | - cable - white paint and white pendant cable |

DANTE 2 – lighting consist of the glass shade and the bar pendant

- | | |
|------------------|--|
| Shade attachment | - steel holder for the hole 110mm |
| Pendant | - rod: B - white paint
S - silver paint |

ОПИСАНИЕ СВЕТИЛЬНИКОВ

DANTE 1 – Светильник состоит из двух освещенных частей (2 стеклянных светорассеивателя) и кабельного подвеса, обе части включаются самостоятельно:

- | | |
|----------------------------------|---|
| 1. основной источник света | - люминесцентная лампа |
| 2. дополнительный источник света | - светодиодные модули |
| Крепление рассеивателя | - металлическое крепление для отверстия 110 мм |
| Подвес | - кабельный: белый лак и белый подвесной кабель |

DANTE 2 – Светильник состоит из стеклянного светорассеивателя и жесткого подвеса

- | | |
|------------------------|---|
| Крепление рассеивателя | - металлическое крепление для отверстия 110 мм |
| Подвес | - жесткий: B - белый лак
S - серебристый лак |

BESCHREIBUNG DER LEUCHTEN

DANTE 1 – Die Leuchte besteht aus zwei Teilen (Glasabdeckungen) und der Kabelaufhängung, beide Teile werden selbständig geschaltet:

- | | |
|-----------------------------|--|
| 1. Hauptlichtquelle | - Leuchtstofflampe |
| 2. Zusatzlichtquelle | - LED Module |
| Halterung der Abdeckscheibe | - Stahlhalter für eine Öffnung mit 110 mm |
| Aufhängung | - Kabelaufhängung – Weißlack und weißes Aufhängungskabel |

DANTE 2 – die Leuchte besteht aus der Glasabdeckung und der Stangen aufhängung

- | | |
|-----------------------------|--|
| Halterung der Abdeckscheibe | - Stahlhalter für eine Öffnung mit 110 mm |
| Aufhängung | - Stangen aufhängung: B - Weißlack
S - Silberlack |

DESCRIPTION DES LUMINAIRES

DANTE 1 – Le luminaire est composé de deux parties lumineuses (2 abat-jours en verre) et d'une suspension par câble, les deux parties peuvent être activées séparément et indépendamment:

- | | |
|---------------------------------|---|
| 1. source de lumière principale | - source fluorescente |
| 2. source supplémentaire | - modules LED |
| Fixation de l'abat-jour | - support en acier pour une ouverture de 110 mm |
| Suspension – câble | - blanc laqué et câble de suspension blanc |

DANTE 2 – Le luminaire se compose d'un abat-jour en verre et d'une suspension par tige

- | | |
|-------------------------|---|
| Fixation de l'abat-jour | - support en acier pour une ouverture de 110 mm |
| Suspension | - tige: B – laqué blanc
S – laque argentée |

DANTE1

DANTE1 IP40

Kód code код	typ type тип	příkon input [W]	lm LED	objímka socket патрон
--------------------	--------------------	------------------------	--------	-----------------------------

A

53610+	ZS11/5L01/457/L100 2/1 3000	40/7	470	E27
53110+	ZS11/5L01/457/L100 2/1 4000	40/7	540	E27

EVG

53611+	E-25ZS11/5L01/457/L100 2/1 3000	2x18/7	470	2xG24q2
53111+	E-25ZS11/5L01/457/L100 2/1 4000	2x18/7	540	2xG24q2

+ - 2/1 – dvouokruhové ovládání světelných zdrojů/ two electric circuits /двухконтурное управление лампами/Lichtquellensteuerung durch 2 Schaltkreise/Commande a 2 circuits électriques



Ø 300 mm

Náhradní stínítko/spare shade/запасное стекло

Kód/code/код	Typ/Type/тип	D [mm]
20090	457-1	135
20091	457-2	300

DANTE 2

DANTE 2 IP40

kód/B code/B код/B	kód/S code/S код/S	typ type тип	příkon input [W]	objímka socket патрон
--------------------------	--------------------------	--------------------	------------------------	-----------------------------

A

53112	53113	Z11/457/a5	75	E27
-------	-------	------------	----	-----

EVG

53114	53115	E-26Z11/457/a5	2x26	2xG24q3
-------	-------	----------------	------	---------

DANTE 1

kabelový závěs /cable pendant/
кабельный подвес/Kabelaufhängung/
Suspension par câble

typ/type	délka/length [mm]
L100	1000

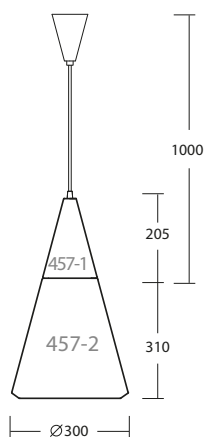

DANTE 2

tyčový závěs /bar pendant/ /жесткий
подвес/Stangenaufhängung/Suspension
par tige

typ/type	délka/length [mm]
a5	1000

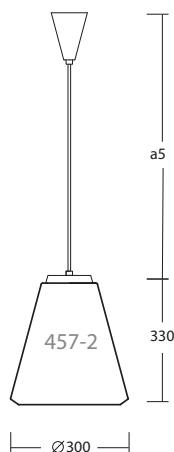

Ø 300 mm

Náhradní stínítko/spare shade/запасное стекло

Kód/code/код	Typ/Type/тип	D [mm]
20091	457-2	300

SATURN L1,2

**POPIS SVÍTIDEL**

Svítidlo tvoří závěs ze tří lanek, montura, dekorativní krycí plechy a skleněné stínítko

Závěs

- 3 nerezová lanka s transparentním přívodním kabelem o délce 1 m nebo 2 m

Držení stínítka

- sklápovací

DESCRIPTION OF THE LIGHTING FITTINGS

The lighting fitting consist of the three wire pendants, decorative cover sheet and the glass shade

Pendant

- 3 stainless steel wire pendants with transparent supply cable in length 1 m or 2 m

Shade attachment

- with folding two-step clamp holders

ОПИСАНИЕ СВЕТИЛЬНИКОВ

Светильник состоит из подвеса состоящего из трех тросов, основания, декоративной защитной крышки и стеклянного светорассеивателя

Подвес

- три стальных троса с прозрачным электрическим кабелем длиной 1 м или 2 м

Крепление рассеивателя

- фиксаторы-защелки

BESCHREIBUNG DER LEUCHTEN

Die Leuchten bestehen aus drei Seilabhängungen, der Armatur, einem dekorativen Schutzblech und einer Glasabdeckung.

Aufhängung

-3 Seilabhängungen mit transparentem Anschlusskabel in einer Länge von 1 m oder 2 m

Halterung der Abdeckscheibe - Klappbare Halterungen

DESCRIPTION DES LUMINAIRES

Les luminaires d'intérieur se composent de trois fils, d'une monture, et d'un abat-jour en verre

Suspension

- 3 câbles d'acier inox avec un cordon d'alimentation transparent d'une longueur de 1 m ou 2 m

Fixation de l'abat-jour

- supports clip

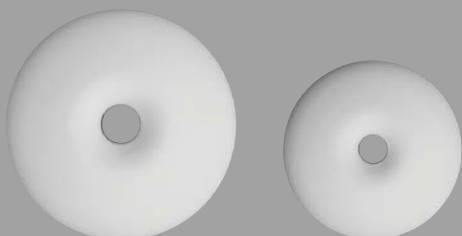

SATURN L 1

SATURN L1 IP20

Kód/L100 code/L100 код/L100	Kód/L200 code/L200 код/L200	typ type тип	Zdroj source лампа	příkon input [W]	objímka socket патрон
EVG					
42425	42426	E-101ZL11/462/L..	☉	22	2GX13

LED IP20

Kód/L100 code/L100 код/L100	Kód/L200 code/L200 код/L200	typ type тип	[lm]	příkon input [W]	záruka Guarantee [years]
3000K					
53119	53116	LED-4L02A07ZL11/462/L.. 3000	1840	20	5
53117	53118	LED-4L02A10ZL11/462/L.. 3000	2460	30	5
4000K					
53619	53616	LED-4L02A07ZL11/462/L.. 4000	1970	20	5
53617	53618	LED-4L02A10ZL11/462/L.. 4000	2630	30	5



Ø 350 mm

Náhradní stínítko / spare shade

Kód/code/код	Typ/Type/тип	D [mm]
20051	462	350

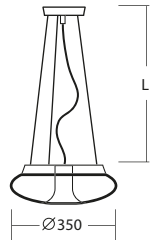

SATURN L2

SATURN L2 IP20

Kód/L100 code/L100 код/L100	Kód/L200 code/L200 код/L200	typ type тип	Zdroj source лампа	příkon input [W]	objímka socket патрон
EVG					
42427	42428	E-102ZL11/482/L..	☉	40	2GX13
42429	42424	E-204ZL11/482/L..	☉	22+40	2x2GX13
42640+	45600+	E-204ZL11/482/L.. 2/1	☉	22+40	2x2GX13
DIM					
45601	45602	ES-204ZL11/482/L.. 1-10V	☉	22+40	2x2GX13
45605	45606	ES-204ZL11/482/L.. DALI	☉	22+40	2x2GX13

+ - 2/1 – dvouokruhové ovládání světelných zdrojů / two electric circuits / двухконтурное управление лампами / Lichtquellensteuerung durch 2 Schaltkreise / Commande a 2 circuits électriques

LED IP20

Kód/L100 code/L100 код/L100	Kód/L200 code/L200 код/L200	typ type тип	[lm]	příkon input [W]	záruka Guarantee [years]
3000K					
53120	53121	LED-6L02A10ZL11/482 3000	3700	43	5
DIM					
53122	53123	LED-6L02A10ZL11/482 1-10V 3000	3700	43	5
53124	53125	LED-6L02A10ZL11/482 DALI 3000	3700	43	5
4000K					
53620	53621	LED-6L02A10ZL11/482 4000	3940	43	5
DIM					
53622	53623	LED-6L02A10ZL11/482 1-10V 4000	3940	43	5
53624	53625	LED-6L02A10ZL11/482 DALI 4000	3940	43	5



Ø 490 mm

Náhradní stínítko / spare shade

Kód/code/код	Typ/Type/тип	D [mm]
20052	482	490

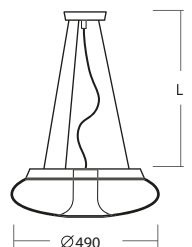

lankový závěs / wire pendant / гибкий подвес / Seilaufhängung / Suspension par fil

typ/type	délka/length [mm]
L100	1000
L200	2000

AURA P3,4,5

CRATER P3,4,5

DRACO P3,4,5

EDNA P3,4,5



POPIS SVÍTIDEL

Svítidla tvoří montura z kovu, skleněné stínítka a tyčový závěs	
Držení stínítka	- sklápovací držáky
Závěs	- tyčový – bílá ocelová trubka o průměru 10mm
Montáž	- na strop

DESCRIPTION OF THE LIGHTING FITTINGS

The light fittings consist of the metal fixture, glass shade and steel bar	
Shade attachment	- with folding two-step holders
Pendant	- steel bar – white steel bar of Φ 10 mm
Assembly	- to the ceiling

ОПИСАНИЕ СВЕТИЛЬНИКОВ

Светильники состоят из металлического основания, стеклянного светорассеивателя и жесткого подвеса	
Крепление рассеивателя	- откидные фиксаторы – защелки
Подвес	- жесткий – металлическая трубка, белого цвета диаметром Φ 10 мм
Установка	- потолочный

BESCHREIBUNG DER LEUCHTEN

Die Leuchten bestehen aus einer Stahlblecharmatur, einer Glasabdeckung und einer Stangenabhängung	
Halterung der Abdeckscheibe	- klappbare Halterungen
Aufhängung	- Stangenabhängung – Stahlstange weiß lackiert Φ 10 mm
Montage	- als Deckenleuchten

DESCRIPTION DES LUMINAIRES

Les luminaires d'intérieur se composent d'une monture métallique, d'un abat-jour en verre et d'une tige de suspension	
Fixation de l'abat-jour	- supports clip
Suspension	- par tige – tube d'acier blanc d'un diamètre de Φ 10 mm
Montage	- sur plafond



AURA P3

AURA P3 IP41

kód/z1 code/z1 код/z1	kód/z2 code/z2 код/z2	kód/z3 code/z3 код/z3	kód/z4 code/z4 код/z4	kód/z5 code/z5 код/z5	typ type тип	příkon input [W]	objímka socket патрон
A							
54001	54002	54003	54004	54005	IN-22ZK64/062/z.	2x75	2xE27
EVG							
54006	54007	54008	54009	54010	E-25ZK64/062/z.	2x18	2xG24q2

LED IP 41

kód/z1 code/z1 код/z1	kód/z2 code/z2 код/z2	kód/z3 code/z3 код/z3	kód/z4 code/z4 код/z4	kód/z5 code/z5 код/z5	typ type тип	[lm]	příkon input [W]	záruka Guarantee [years]
3000K								
54300	54301	54302	54303	54304	LED-1L13A07ZK64/062/z. 3000	1480	16	3
54305	54306	54307	54308	54309	LED-4L02A10ZK64/062/z. 3000	2460	30	5
4000K								
54800	54801	54802	54803	54804	LED-1L13A07ZK64/062/z. 4000	1480	16	3
54805	54806	54807	54808	54809	LED-4L02A10ZK64/062/z. 4000	2630	30	5



Ø 350 mm

Náhradní stínítko/spare shade/запасное стекло

Kód/code/код	Typ/Type/тип	D [mm]
20003	062	350

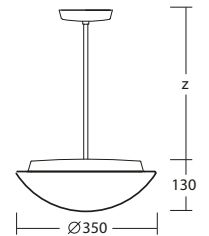

AURA P4

AURA P4 IP41

kód/z1 code/z1 код/z1	kód/z2 code/z2 код/z2	kód/z3 code/z3 код/z3	kód/z4 code/z4 код/z4	kód/z5 code/z5 код/z5	typ type тип	příkon input [W]	objímka socket патрон
A							
54011	54012	54013	54014	54015	IN-22ZK75/072/z.	2x75	2x E27
EVG							
54016	54017	54018	54019	54020	E-26ZK75/072/z.	2x26	2xG24q3

LED IP 41

kód/z1 code/z1 код/z1	kód/z2 code/z2 код/z2	kód/z3 code/z3 код/z3	kód/z4 code/z4 код/z4	kód/z5 code/z5 код/z5	typ type тип	[LM]	příkon input [W]	záruka Guarantee [years]
3000K								
54310	54311	54312	54313	54314	LED-1L14A07ZK75/072/z. 3000	1970	21	3
54315	54316	54317	54318	54319	LED-5L02A10ZK75/072/z. 3000	3080	37	5
4000K								
54810	54811	54812	54813	54814	LED-1L14A07ZK75/072/z. 4000	1970	21	3
54815	54816	54817	54818	54819	LED-5L02A10ZK75/072/z. 4000	3280	37	5



Ø 420 mm

Náhradní stínítko/spare shade/запасное стекло

Kód/code/код	Typ/Type/тип	D [mm]
20004	072	420

tyčový závěs / bar pendant / жесткий подвес / Stangenaufhängung / Suspension par tige

typ/type	délka/length [mm]
z1	200
z2	400
z3	600
z4	800
z5	1000

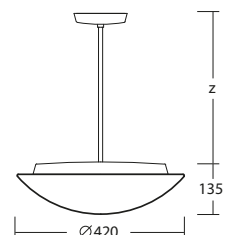

AURA P5

NOVINKA/NEW



Ø 490 mm

Náhradní stínítko/spare shade/запасное стекло

Kód/code/код	Typ/Type/тип	D [mm]
20005	082	490

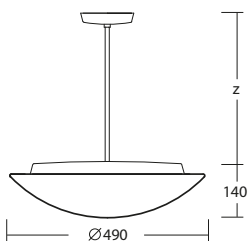

AURA P5 IP41

kód/z1 code/z1 код/z1	kód/z2 code/z2 код/z2	kód/z3 code/z3 код/z3	kód/z4 code/z4 код/z4	kód/z5 code/z5 код/z5	typ type тип	příkon input [W]	objímka socket патрон
A							
54021	54022	54023	54024	54025	IN-32ZK86/082/z.	3x60	3xE27
EVG							
54026	54027	54028	54029	54030	E-27ZK86/082/z.	2x36	2xG10

LED IP 41

kód/z1 code/z1 код/z1	kód/z2 code/z2 код/z2	kód/z3 code/z3 код/z3	kód/z4 code/z4 код/z4	kód/z5 code/z5 код/z5	typ type тип	[lm]	příkon input [W]	záruka Guarantee [years]
3000K								
54320	54321	54322	54323	54324	LED-4L11A07ZK86/082/z. 3000	2950	30	3
54325	54326	54327	54328	54329	LED-6L02A10ZK86/082/z. 3000	3700	43	5*
4000K								
54820	54821	54822	54823	54824	LED-4L11A07ZK86/082/z. 4000	2950	30	3
54825	54826	54827	54828	54829	LED-6L02A10ZK86/082/z. 4000	3940	43	5*

CRATER P3

NOVINKA/NEW



Ø 350 mm

Náhradní stínítko/spare shade/запасное стекло

Kód/code/код	Typ/Type/тип	D [mm]
20059	053	350

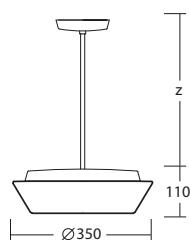

tučový závěs/ bar pendant/ жесткий
подвес/Stangenaufhängung/Suspension
par tige

typ/type	délka/length [mm]
z1	200
z2	400
z3	600
z4	800
z5	1000

CRATER P3 IP41

kód/z1 code/z1 код/z1	kód/z2 code/z2 код/z2	kód/z3 code/z3 код/z3	kód/z4 code/z4 код/z4	kód/z5 code/z5 код/z5	typ type тип	příkon input [W]	objímka socket патрон
A							
54031	54032	54033	54034	54035	IN-22ZK64/053/z.	2x75	2xE27
EVG							
54036	54037	54038	54039	54040	E-25ZK64/053/z.	2x18	2xG24q2

LED IP 41

kód/z1 code/z1 код/z1	kód/z2 code/z2 код/z2	kód/z3 code/z3 код/z3	kód/z4 code/z4 код/z4	kód/z5 code/z5 код/z5	typ type тип	[lm]	příkon input [W]	záruka Guarantee [years]
3000K								
54330	54331	54332	54333	54334	LED-1L13A07ZK64/053/z. 3000	1480	16	3
54335	54336	54337	54338	54339	LED-4L02A10ZK64/053/z. 3000	2460	30	5
4000K								
54830	54831	54832	54833	54834	LED-1L13A07ZK64/053/z. 4000	1480	16	3
54835	54836	54837	54838	54839	LED-4L02A10ZK64/053/z. 4000	2630	30	5

CRATER P4

CRATER P4 IP41

kód/z1 code/z1 код/z1	kód/z2 code/z2 код/z2	kód/z3 code/z3 код/z3	kód/z4 code/z4 код/z4	kód/z5 code/z5 код/z5	typ type тип	příkon input [W]	objímka socket патрон
54041	54042	54043	54044	54045	IN-22ZK75/054/z.	2x75	2x E27
EVG							
54046	54047	54048	54049	54050	E-26ZK75/054/z.	2x26	2xG24q3

LED IP 41

kód/z1 code/z1 код/z1	kód/z2 code/z2 код/z2	kód/z3 code/z3 код/z3	kód/z4 code/z4 код/z4	kód/z5 code/z5 код/z5	typ type тип	[lm]	příkon input [W]	záruka Guarantee [years]
3000K								
54340	54341	54342	54343	54344	LED-1L14A07ZK75/054/z. 3000	1970	25	3
54345	54346	54347	54348	54349	LED-5L02A10ZK75/054/z. 3000	3080	32	5
4000K								
54840	54841	54842	54843	54844	LED-1L14A07ZK75/054/z. 4000	1970	25	3
54845	54846	54847	54848	54849	LED-5L02A10ZK75/054/z. 4000	3280	32	5



Ø 420 mm

Náhradní stínítko/spare shade/запасное стекло

Kód/code/код	Typ/Type/тип	D [mm]
20060	054	420

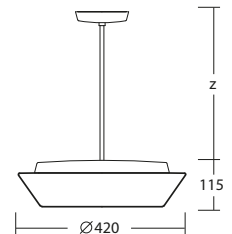

CRATER P5

CRATER P5 IP41

kód/z1 code/z1 код/z1	kód/z2 code/z2 код/z2	kód/z3 code/z3 код/z3	kód/z4 code/z4 код/z4	kód/z5 code/z5 код/z5	typ type тип	příkon input [W]	objímka socket патрон
54051	54052	54053	54054	54055	IN-32ZK86/055/z.	3x60	3x E27
EVG							
54056	54057	54058	54059	54060	E-27ZK86/055/z.	2x36	2xG10

LED IP 41

kód/z1 code/z1 код/z1	kód/z2 code/z2 код/z2	kód/z3 code/z3 код/z3	kód/z4 code/z4 код/z4	kód/z5 code/z5 код/z5	typ type тип	[lm]	příkon input [W]	záruka Guarantee [years]
3000K								
54350	54351	54352	54353	54354	LED-4L11A07ZK86/055/z. 3000	2950	30	3
54355	54356	54357	54358	54359	LED-6L02A10ZK86/055/z. 3000	3700	43	5*
4000K								
54850	54851	54852	54853	54854	LED-4L11A07ZK86/055/z. 4000	2950	30	3
54855	54856	54857	54858	54859	LED-6L02A10ZK86/055/z. 4000	3940	43	5*



Ø 490 mm

Náhradní stínítko/spare shade/запасное стекло

Kód/code/код	Typ/Type/тип	D [mm]
20061	055	490

tyčový závěs/ bar pendant/ жесткий подвес/ Stangenaufhängung/ Suspension par tige

typ/type	délka/length [mm]
z1	200
z2	400
z3	600
z4	800
z5	1000

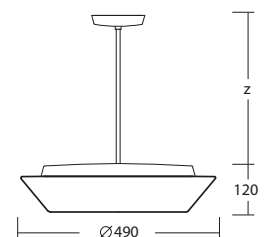

DRACO P3

NOVINKA/NEW



Ø 350 mm

Náhradní stínítko/spare shade/запасное стекло

Kód/code/код	Typ/Type/тип	D [mm]
20064	253	350

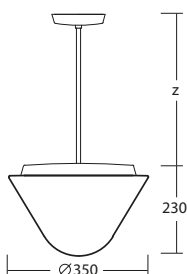

DRACO P3 IP41

kód/z1 code/z1 код/z1	kód/z2 code/z2 код/z2	kód/z3 code/z3 код/z3	kód/z4 code/z4 код/z4	kód/z5 code/z5 код/z5	typ type тип	přikon input [W]	objímka socket патрон
A							
54061	54062	54063	54064	54065	IN-22ZK64/253/z.	2x75	2xE27
EVG							
54066	54067	54068	54069	54070	E-25ZK64/253/z.	2x18	2xG24q2

LED IP 41

kód/z1 code/z1 код/z1	kód/z2 code/z2 код/z2	kód/z3 code/z3 код/z3	kód/z4 code/z4 код/z4	kód/z5 code/z5 код/z5	typ type тип	[lm]	přikon input [W]	záruka Guarantee [years]
3000K								
54360	54361	54362	54363	54364	LED-1L13A07ZK64/253/z. 3000	1480	16	3
54365	54366	54367	54368	54369	LED-4L02A10ZK64/253/z. 3000	2460	30	5
4000K								
54860	54861	54862	54863	54864	LED-1L13A07ZK64/253/z. 4000	1480	16	3
54865	54866	54867	54868	54869	LED-4L02A10ZK64/253/z. 4000	2630	30	5

DRACO P4

NOVINKA/NEW



Ø 420 mm

Náhradní stínítko/spare shade/запасное стекло

Kód/code/код	Typ/Type/тип	D [mm]
20065	254	420

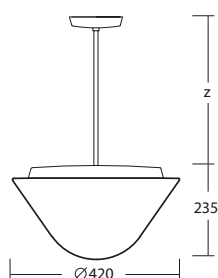

DRACO P4 IP41

kód/z1 code/z1 код/z1	kód/z2 code/z2 код/z2	kód/z3 code/z3 код/z3	kód/z4 code/z4 код/z4	kód/z5 code/z5 код/z5	typ type тип	přikon input [W]	objímka socket патрон
A							
54071	54072	54073	54074	54075	IN-22ZK75/254/z.	2x75	2xE27
EVG							
54076	54077	54078	54079	54080	E-26ZK75/254/z.	2x26	2xG24q3

LED IP 41

kód/z1 code/z1 код/z1	kód/z2 code/z2 код/z2	kód/z3 code/z3 код/z3	kód/z4 code/z4 код/z4	kód/z5 code/z5 код/z5	typ type тип	[lm]	přikon input [W]	záruka Guarantee [years]
3000K								
54370	54371	54372	54373	54374	LED-1L14A07ZK75/254/z. 3000	1970	21	3
54375	54376	54377	54378	54379	LED-5L02A10ZK75/254/z. 3000	3080	37	5
4000K								
54870	54871	54872	54873	54874	LED-1L14A07ZK75/254/z. 4000	1970	21	3
54875	54876	54877	54878	54879	LED-5L02A10ZK75/254/z. 4000	3280	37	5

DRACO P5

DRACO P5 IP41

kód/z1 code/z1 код/z1	kód/z2 code/z2 код/z2	kód/z3 code/z3 код/z3	kód/z4 code/z4 код/z4	kód/z5 code/z5 код/z5	typ type тип	příkon input [W]	objímka socket патрон
54081	54082	54083	54084	54085	IN-32ZK86/255/z.	3x60	3x E27
EVG							
54086	54087	54088	54089	54090	E-27ZK86/255/z.	2x36	2x2G10

LED IP 41

kód/z1 code/z1 код/z1	kód/z2 code/z2 код/z2	kód/z3 code/z3 код/z3	kód/z4 code/z4 код/z4	kód/z5 code/z5 код/z5	typ type тип	[lm]	příkon input [W]	záruka Guarantee [years]
3000K								
54380	54381	54382	54383	54384	LED-4L11A07ZK86/255/z. 3000	2950	30	3
54385	54386	54387	54388	54389	LED-6L02A10ZK86/255/z. 3000	3700	43	5*
4000K								
54880	54881	54882	54883	54884	LED-4L11A07ZK86/255/z. 4000	2950	30	3
54885	54886	54887	54888	54889	LED-6L02A10ZK86/255/z. 4000	3940	43	5*



Náhradní stínítko/spare shade/запасное стекло

Kód/code/код	Typ/Type/тип	D [mm]
20066	255	490

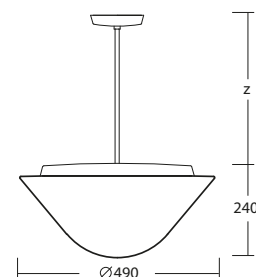

EDNA P3

EDNA P3 IP41

kód/z1 code/z1 код/z1	kód/z2 code/z2 код/z2	kód/z3 code/z3 код/z3	kód/z4 code/z4 код/z4	kód/z5 code/z5 код/z5	typ type тип	příkon input [W]	objímka socket патрон
54091	54092	54093	54094	54095	IN-22ZK64/024/z.	2x75	2xE27
EVG							
54096	54097	54098	54099	54100	E-25ZK64/024/z.	2x18	2xG24q2

LED IP 41

kód/z1 code/z1 код/z1	kód/z2 code/z2 код/z2	kód/z3 code/z3 код/z3	kód/z4 code/z4 код/z4	kód/z5 code/z5 код/z5	typ type тип	[lm]	příkon input [W]	záruka Guarantee [years]
3000K								
54390	54391	54392	54393	54394	LED-1L13A07ZK64/024/z. 3000	1480	16	3
54395	54396	54397	54398	54399	LED-4L02A10ZK64/024/z. 3000	2460	30	5
4000K								
54890	54891	54892	54893	54894	LED-1L13A07ZK64/024/z. 4000	1480	16	3
54895	54896	54897	54898	54899	LED-4L02A10ZK64/024/z. 4000	2630	30	5



Náhradní stínítko/spare shade/запасное стекло

Kód/code/код	Typ/Type/тип	D [mm]
20011	024	350

tyčový závěs/ bar pendant/ жесткий подвес/ Stangenaufhängung/ Suspension par tige

typ/type	délka/length [mm]
z1	200
z2	400
z3	600
z4	800
z5	1000

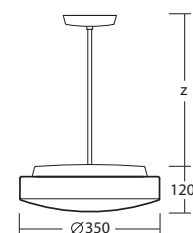

EDNA P4

NOVINKA/NEW



Ø 420 mm

Náhradní stínítko/spare shade/запасное стекло

Kód/code/код	Typ/Type/тип	D [mm]
20054	026	420

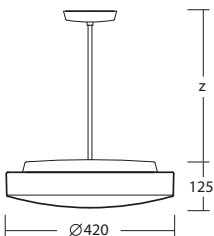

EDNA P4 IP41

kód/z1 code/z1 код/z1	kód/z2 code/z2 код/z2	kód/z3 code/z3 код/z3	kód/z4 code/z4 код/z4	kód/z5 code/z5 код/z5	typ type тип	příkon input [W]	objímka socket патрон
A							
54101	54102	54103	54104	54105	IN-22ZK75/026/z.	2x75	2x E27
EVG							
54106	54107	54108	54109	54110	E-26ZK75/026/z.	2x26	2x G24q3

LED IP41

kód/z1 code/z1 код/z1	kód/z2 code/z2 код/z2	kód/z3 code/z3 код/z3	kód/z4 code/z4 код/z4	kód/z5 code/z5 код/z5	typ type тип	[lm]	příkon input [W]	záruka Guarantee [years]
3000K								
54900	54901	54902	54903	54904	LED-1L14A07ZK75/026/z. 3000	1970	21	3
54905	54906	54907	54908	54909	LED-5L02A10ZK75/026/z. 3000	3080	37	5
4000K								
54400	54401	54402	54403	54404	LED-1L14A07ZK75/026/z. 4000	1970	21	3
54405	54406	54407	54408	54409	LED-5L02A10ZK75/026/z. 4000	3280	37	5

EDNA P5

NOVINKA/NEW



Ø 490 mm

Náhradní stínítko/spare shade/запасное стекло

Kód/code/код	Typ/Type/тип	D [mm]
20070	028	490

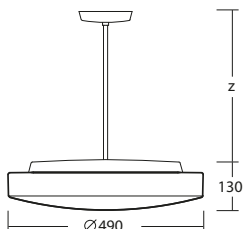
tyčový závěs/ bar pendant/ жесткий
подвес/Stangenaufhängung/Suspension
par tige

typ/type	délka/length [mm]
z1	200
z2	400
z3	600
z4	800
z5	1000

EDNA P5 IP41

kód/z1 code/z1 код/z1	kód/z2 code/z2 код/z2	kód/z3 code/z3 код/z3	kód/z4 code/z4 код/z4	kód/z5 code/z5 код/z5	typ type тип	příkon input [W]	objímka socket патрон
A							
54111	54112	54113	54114	54115	IN-32ZK88/028/z.	3x60	3x E27
EVG							
54116	54117	54118	54119	54120	E-27ZK88/028/z.	2x36	2x G10

LED IP41

kód/z1 code/z1 код/z1	kód/z2 code/z2 код/z2	kód/z3 code/z3 код/z3	kód/z4 code/z4 код/z4	kód/z5 code/z5 код/z5	typ type тип	[lm]	příkon input [W]	záruka Guarantee [years]
3000K								
54410	54411	54412	54413	54414	LED-4L11A07ZK88/028/z. 3000	2950	30	3
54415	54416	54417	54418	54419	LED-6L02A10ZK88/028/z. 3000	3700	43	5*
4000K								
54910	54911	54912	54913	54914	LED-4L11A07ZK88/028/z. 4000	2950	30	3
54915	54916	54917	54918	54919	LED-6L02A10ZK88/028/z. 4000	3940	43	5*



AURA T5,9 CRATER T5 DRACO T5 EDNA T5 LINA L7



POPIS SVÍTIDEL

Svítidla jsou tvořena kovovou monturou, skleněným stínítkem a lankovým závěsem

Třílankový závěs - AURA T5,9, CRATER T5, DRACO T5, EDNA T5

třílankový závěs je ze dvou částí:
1. jednoduché lanko
2. tři lanka spojené v jednom úchytu

Lankový závěs - LINA L7

Závěs tvoří 3 nerezová lanka s transparentním přívodním kabelem

Barva závěsu - stříbrný lak

Držení stínítka - s klapovacími držáky

Montáž - na strop

DESCRIPTION OF THE LIGHTING FITTINGS

The lighting fittings consist of metal fixture, glass shade and the cable pendant

3- wire pendant - AURA T5,9, CRATER T5, DRACO T5, EDNA T5

Three wire consist of the two parts:
1. Simple wire
2. three wires connected in one lug

Wire pendant - LINA L7

The pendant consist of three stainless steel wire pendants with transparent supply cable

Pendant colour - chrome matt paint

Shade attachment - with folding two-step clamp holders

Assembly - to the ceiling

ОПИСАНИЕ СВЕТИЛЬНИКОВ

Светильники состоят из металлического основания, стеклянного светорассеивателя и гибкого подвеса двух видов:

Подвес из трех стальных тросов - AURA T5,9, CRATER T5, DRACO T5, EDNA T5

состоит из двух частей:
1- обыкновенный трос
2- три стальных троса соединенные в одном креплении

Гибкий подвес - LINA L7

состоит из трех отдельных стальных тросов с прозрачным электрическим кабелем

Цвет подвеса - серебристый лак

Крепление рассеивателя - откидные фиксаторы - защелки,

Установка - потолочный

BESCHREIBUNG DER LEUCHTEN

Die Leuchten bestehen aus einer Stahlblecharmatur, einer Glasabdeckung und einer Kabelaufhängung

3- Seilaufhängungen- AURA T5,9, CRATER T5, DRACO T5, EDNA T5

Dreiseilaufhängungen bestehen aus zwei Teilen: 1. Einfaches Seil
2. Drei Seile verbunden in einer Halterung

Seilaufhängung - LINA L7

Aufhängung besteht aus drei Seilaufhängungen mit transparentem Anschlusskabel

Farbe der Aufhängung - Chromlack matt

Halterung der Abdeckscheibe - klappbare Halterungen

Montage - als Deckenleuchte

DESCRIPTION DES LUMINAIRES

Tous les luminaires d'intérieur se composent d'une monture métallique, d'un abat-jour en verre et d'une suspension par câble

3- câble suspension - AURA T5,9, CRATER T5, DRACO T5, EDNA T5

Trois - câble suspension est constituée de deux parties: 1. Un simple fil
2. trois fils reliés par un connecteur

Suspension par fil - LINA L7

Suspension est composé de trois fils avec un cordon d'alimentation transparent

suspension - laqué chrome mate

Pose du luminaire - support clip

Installation - sur le plafond

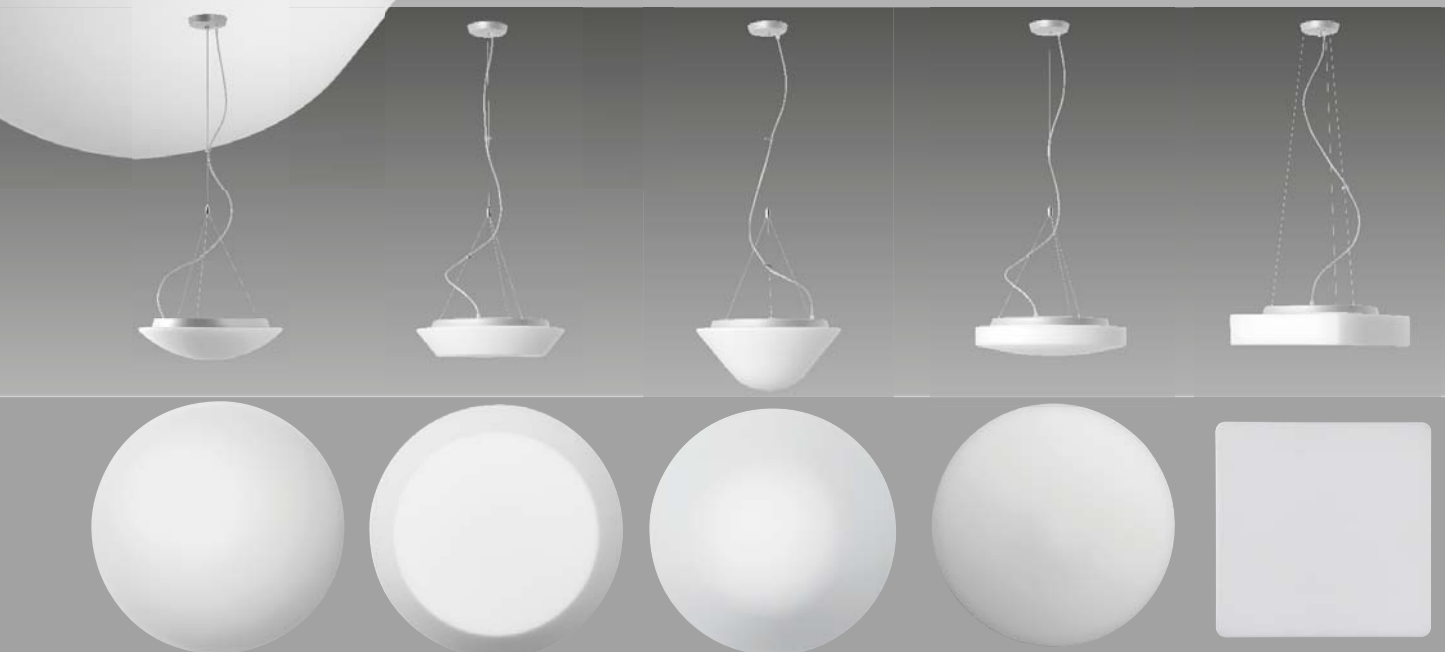

AURA T5

AURA T5 IP41

kód code код	typ type тип	příkon input [W]	objímka socket патрон
A			
54130	IN-32ZT86/082/L100	3x60	3x E27
EVG			
54131	E-27ZT86/082/L100	2x36	2x G10

LED IP41

kód code код	typ type тип	[lm]	příkon input [W]	záruka Guarantee [years]
3000K				
54430	LED-4L11A07ZT86/082/L100 3000	2950	30	3
54431	LED-6L02A10ZT86/082/L100 3000	3700	43	5*
4000K				
54930	LED-4L11A07ZT86/082/L100 4000	2950	30	3
54931	LED-6L02A10ZT86/082/L100 4000	3940	43	5*

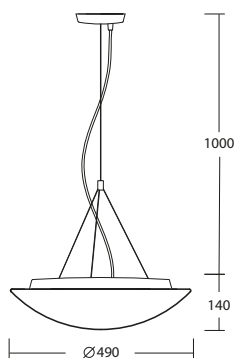

lankový závěs / wire pendant / гибкий
подвес / Seilabhängung / Suspension
par fil

typ/type	délka/length [mm]
T100	1000

Ø 490 mm

Náhradní stínítko/spare shade/запасное стекло

Kód/code/код	Typ/Type/тип	D [mm]
20005	082	490

AURA T9

AURA T9 IP41

kód code код	typ type тип	příkon input [W]	objímka socket патрон
A			
54132	IN-32ZT98/084/L100	3x75	3x E27
EVG			
54133	E-46ZT98/084/L100	4x26	4x G24q3

LED IP41

kód code код	typ type тип	[lm]	příkon input [W]	záruka Guarantee [years]
3000K				
54432	LED-4L12A07ZT98/084/L100 3000	3940	41	3
54433	LED-8L02A10ZT98/084/L100 3000	4930	58	5*
4000K				
54932	LED-4L12A07ZT98/084/L100 4000	3940	41	3
54933	LED-8L02A10ZT98/084/L100 4000	5250	58	5*

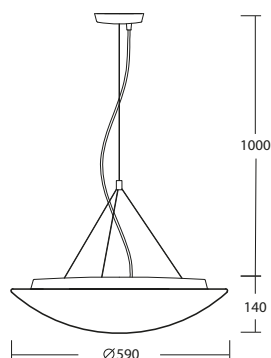

Ø 590 mm

Náhradní stínítko/spare shade/запасное стекло

Kód/code/код	Typ/Type/тип	D [mm]
20050	084	590

* viz str. „See, см. страница, Siehe, voir : 204

CRATER T5

NOVINKA/NEW



Ø 490 mm

Náhradní stínítko/spare shade/
запасное стекло

Kód/code/код	Typ/Type/тип	D [mm]
20061	055	490

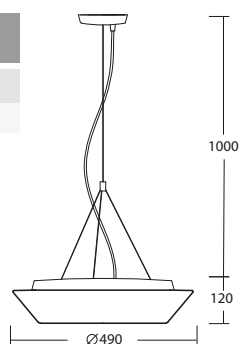

CRATER T5 IP41

kód code код	typ type тип	příkon input [W]	objímka socket патрон
A			
54135	IN-32ZT86/055/L100	3x60	3x E27
EVG			
54136	E-27ZT86/055/L100	2x36	2x2G10

LED IP41

kód code код	typ type тип	[lm]	příkon input [W]	záruka Guarantee [years]
3000K				
54434	LED-4L11A07ZT86/055/L100 3000	2950	30	3
54435	LED-6L02A10ZT86/055/L100 3000	3700	43	5*
4000K				
54934	LED-4L11A07ZT86/055/L100 4000	2950	30	3
54935	LED-6L02A10ZT86/055/L100 4000	3940	43	5*

DRACO T5

NOVINKA/NEW



Ø 490 mm

Náhradní stínítko/spare shade/
запасное стекло

Kód/code/код	Typ/Type/тип	D [mm]
20066	255	490

lankový závěs / wire pendant / гибкий
подвес / Seilabhängung / Suspension
par fil

typ/type	délka/length [mm]
T100	1000

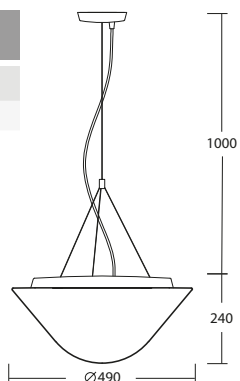

DRACO T5 IP41

kód code код	typ type тип	příkon input [W]	objímka socket патрон
A			
54138	IN-32ZT86/255/L100	3x60	3x E27
EVG			
54139	E-27ZT86/255/L100	2x36	2x2G10

LED IP41

kód code код	typ type тип	[lm]	příkon input [W]	záruka Guarantee [years]
3000K				
54436	LED-4L11A07ZT86/255/L100 3000	2950	30	3
54437	LED-6L02A10ZT86/255/L100 3000	3700	43	5*
4000K				
54936	LED-4L11A07ZT86/255/L100 4000	2950	30	3
54937	LED-6L02A10ZT86/255/L100 4000	3940	43	5*

EDNA T5

EDNA T5 IP41			
kód code код	typ type тип	příkon input [W]	objímka socket патрон
A			
54141	IN-32ZT88/028/L100	3x60	3x E27
EVG			
54142	E-27ZT88/028/L100	2x36	2x2G10

LED IP41				
kód/ code код	typ type тип	[lm]	příkon input [W]	záruka Guarantee [years]
3000K				
54438	LED-4L11A07ZT88/028/L100 3000	2950	30	3
54439	LED-6L02A10ZT88/028/L100 3000	3700	43	5*
4000K				
54938	LED-4L11A07ZT88/028/L100 4000	2950	30	3
54939	LED-6L02A10ZT88/028/L100 4000	3940	43	5*



Náhradní stínítko/spare shade/ запасное стекло

Kód/code/код	Typ/Type/тип	D [mm]
20070	028	490

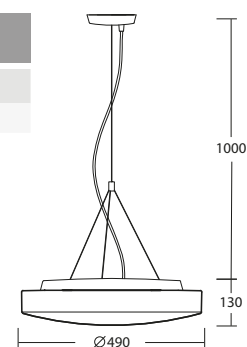

LINA L7

LINAL7 IP41			
kód code код	typ type тип	příkon input [W]	objímka socket патрон
A			
54998	IN-32ZL88/139/L100	3x60	3x E27
EVG			
54999	E-27ZL88/139/L100	2x36	2x2G10

LED IP41				
kód/ code код	typ type тип	[lm]	příkon input [W]	záruka Guarantee [years]
3000K				
49191	LED-4L11A07ZL88/139/L100 3000	2950	30	3
49192	LED-6L02A10ZL88/139/L100 3000	3700	43	5*
4000K				
49691	LED-4L11A07ZL88/139/L100 4000	2950	30	3
49692	LED-6L02A10ZL88/139/L100 4000	3940	43	5*



Náhradní stínítko/spare shade/ запасное стекло

Kód/code/код	Typ/Type/тип	a x b / размер/mm
20071	139	440x440

lankový závěs / wire pendant / гибкий подвес / Seilaufhängung/Suspension par fil

typ/type	délka/length [mm]
L100	1000

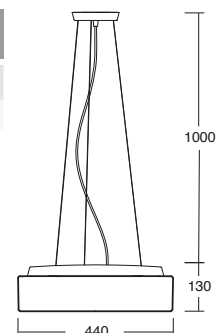

MIRA R

**POPIS SVÍTIDEL**

Svítidlo tvoří montura se třemi řetězovými závěsy a skleněné stínítko
 Držení stínítka - šroubkové
 Montáž - na strop
 Upozornění: závěsná svítidla lze vybavit i LED zdroj – viz AURA 3

DESCRIPTION OF THE LIGHTING FITTINGS

The lighting fittings consist of the fixture with three chain pendants and the glass shade
 Shade attachment - with screws
 Assembly - to the ceiling
 Notice: It is possible to equip the pendant lighting also with LED sources – see Aura 3

ОПИСАНИЕ СВЕТИЛЬНИКОВ

Светильник состоит из основания с подвесом из трех цепей и стеклянного светорассеивателя
 Крепление рассеивателя - винтовое соединение
 Установка - потолочный
 Внимание: подвесные светильники могут быть оборудованы светодиодными модулями – см. AURA 3

BESCHREIBUNG DER LEUCHTEN

Die Leuchten bestehen aus drei Kettenaufhängungen und einer Glasabdeckung.
 Halterung der Abdeckscheibe - Schraubenhalterungen
 Montage - als Deckenleuchten
 Hinweis: Pendelleuchten können auch mit einer LED - Lampe ausgestattet werden – siehe Aura 3

DESCRIPTION DES LUMINAIRES

Les luminaires d'intérieur se composent de trois suspensions par chaîne et d'un abat-jour en verre
 Fixation de l'abat-jour - par vis
 Montage - sur un plafond
 Remarque: Les luminaires suspendus peuvent également être équipés de LED – voir AURA 3

**Provedení řetězových závěsů/Chain pendant colours/Варианты покрытия подвесов (цепей)/
Ausführung der Kettenaufhängungen/Installation des suspensions par chaîne**

SB - starobronz/old bronze/старинная бронза/Altbronze/bronze ancien

MS - mosaz/brass/латунь/Messing/laiton

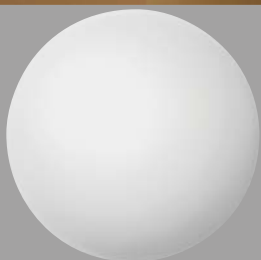

MIRA R IP41

kód/r2 code/r2 код/р2	kód/r3 code/r3 код/р3	kód/r4 code/r4 код/р4	kód/r5 code/r5 код/р5	typ type тип	příkon input [W]	objímka socket патрон
-----------------------------	-----------------------------	-----------------------------	-----------------------------	--------------------	------------------------	-----------------------------

Mira R-MS mosaz /brass

42280	42281	42282	42283	Z11/195/r. MS	150	E27
-------	-------	-------	-------	---------------	-----	-----

EVG

42284	42285	42286	42287	E-26Z11/195/r. MS	2x26	2xG24q3
45607	45608	45609	45610	E-26Z11/195/r. MS 32W	2x32	2xGX24q3

Mira R-SB bronz /old bronze

42292	42293	42294	42295	Z11/195/r. SB	150	E27
-------	-------	-------	-------	---------------	-----	-----

EVG

42296	42297	42298	42299	E-26Z11/195/r. SB	2x26	2xG24q3
45611	45612	45613	45614	E-26Z11/195/r. SB 32W	2x32	2xGX24q3



Ø 350mm

Náhradní stínítko/spare shade/запасное стекло

Kód/code/код	Typ/Type/тип	D [mm]
20049	195	Ø 350

**řetězový závěs /chain pendant/цепь/
Kettenaufhängung/Suspension par
chaine**

Typ/Type/тип	délka/length [mm]
r2	400
r3	600
r4	800
r5	1000

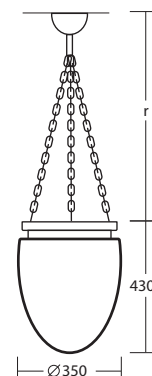

GALAXIA L



POPIS SVÍTIDEL

Svítidla Altair 1S a 2S umožňují svoji konstrukcí a designem vytvářet i závěsné sestavy podle individuálních požadavků.

Spojení základů a svítidel	- šroubové
Montáž sestavy	- na strop
Propojení sestavy	- spojovacími kabely bočními průchody
Grafický návrh sestavy	- lze sestavit konfiguratorem na www.osmont.cz

DESCRIPTION OF THE LIGHTING FITTINGS

Lighting fittings Altair 1S and 2S enables with its construction and design to compose the sets according to the individual requirements.

Connection of the bases and lighting fittings - screws	
Assembly of the set	- to the ceiling
Interconnection of the set	- by the connecting cables through side corridors
Graphic design of the set	- you can form it by configurator www.osmont.cz

ОПИСАНИЕ ИНДИВИДУАЛЬНОЙ КОНФИГУРАЦИИ СВЕТИЛЬНИКОВ

Светильники ALTAIR 1S и 2S предназначены для включения в состав композиций, отличаются по конструкции от обыкновенных, устанавливаемых по отдельности светильников

Установка набора	- настенный/потолочный
Подключение набора	- соединительными кабелями через боковые каналы
Графический расчет проекта	- можно осуществить с помощью конфигуратора www.osmont.cz

BESCHREIBUNG DER LEUCHTEN

Die Konstruktion und das Design der Leuchten Altair 1S und 2S machen die Zusammenstellung von Leuchten - Sets nach individuellen Anforderungen möglich.

Verbindung der Grundplatten mit den Leuchten - Schraubenverbindung	
Montage des Sets	- Deckenleuchten
Verbindung des Sets	- durch Verbindungskabel in seitlichen Durchgangsöffnungen
Der grafische Set-Entwurf	- kann mit dem Konfigurator unter www.osmont.cz erstellt werden

DESCRIPTION

Les luminaires Altair 1S et 2S permettent, par leur construction et leur conception, de créer des combinaisons selon les exigences individuelles.

Connexion des bases et des luminaires	- à vis
Kit de montage	- sur le plafond
Connexion des combinaisons	- connexion des câbles sur le côté latéral
Suggestion graphique de conception	- peut être configurer sur www.osmont.cz



GALAXIA L1 IP41

kód code код	typ type тип	Zdroj source лампа	příkon input [W]	objímka socket патрон
EVG				
57000	12xE-25USZ21/421/L200		24x18	24xG24q2
DIM				
57002	12xE-25USZ21/421/L200 1-10V		24x18	24xG24q2
57003	12xE-25USZ21/421/L200 DALI		24x18	24xG24q2

LED IP41

code код	code код	typ type тип	[lm] 3000K	[lm] 4000K	příkon input [W]	záruka Guarantee [years]
57100	57600	12xLED-5L02A07USZ21/421/L200.000	27600	29520	288	5*
DIM						
57101	57601	12xLED-5L02A07USZ21/421/L200 1-10V.000	27600	29520	288	5
57102	57602	12xLED-5L02A07USZ21/421/L200 DALI.000	27600	29520	288	5

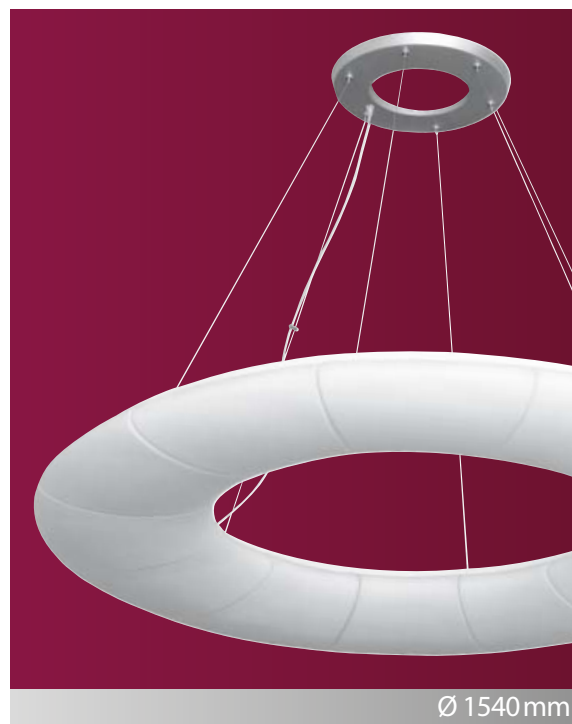

Ø 1540 mm

lankový závěs / wire pendant / гибкий подвес / Seilabhängung / Suspension par fil

typ/type	délka/length [mm]
L200	2000

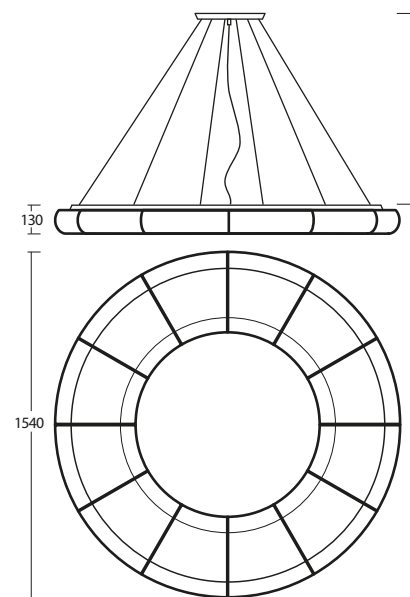
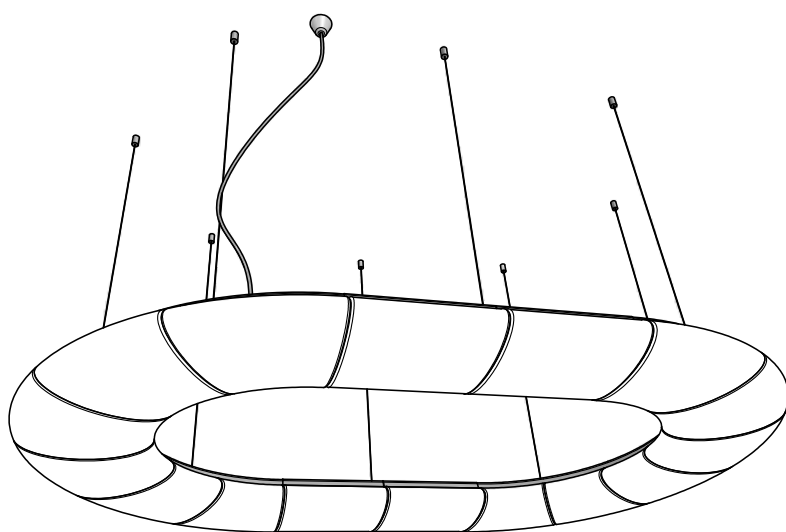

SVÍTIDLA PRO INDIVIDUÁLNÍ SESTAVU

GALAXIA L

LIGHT FITTINGS FOR INDIVIDUAL SET

СВЕТИЛЬНИКИ ДЛЯ ИНДИВИДУАЛЬНОЙ КОНФИГУРАЦИИ

DIE LEUCHTEN FÜR INDIVIDUELLE SETS

LUMINAIRES POUR LA COMPOSITION PERSONNELLE



350x350 mm

Náhradní stínítko/spare shade/запасное стекло

Kód/code/код	Typ/Type/тип	a x b/размер [mm]
20072	420	350x350

ALTAIR 1S IP41

kód code код	typ type тип	Zdroj source лампа	příkon input [W]	objímka socket патрон
--------------------	--------------------	--------------------------	------------------------	-----------------------------

EVG

44100	E-25USZ20/420/100		2x18	2xG24q2
-------	-------------------	--	------	---------

DIM

44101	ES-25USZ20/420/L100 1-10V		2x18	2xG24q2
44102	ES-25USZ20/420/L100 DALI		2x18	2xG24q2

LED IP41

code код 3000	code код 4000	typ type тип	[lm] 3000K	[lm] 4000K	příkon input [W]	záruka Guarantee [years]
57150	57650	LED-6L02A07USZ20/420/L100 .000	2770	2950	29	5*

DIM

57151	57651	LED-6L02A07USZ20/420/L100 DALI .000	2770	2950	29	5
-------	-------	-------------------------------------	------	------	----	---

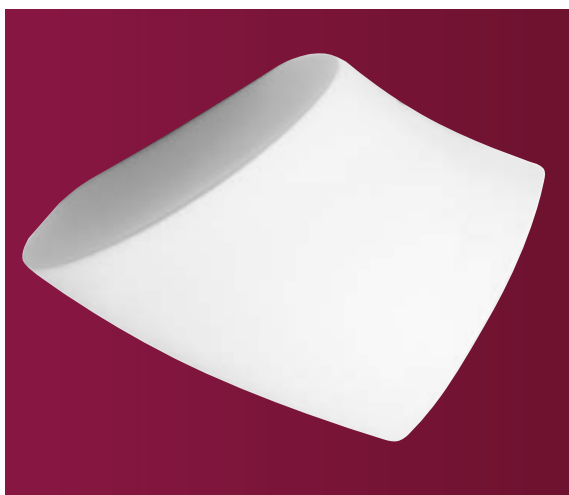

390x360 mm

Náhradní stínítko/spare shade/запасное стекло

Kód/code/код	Typ/Type/тип	a x b/размер [mm]
20073	421	390x360

ALTAIR 2S IP41

kód code код	typ type тип	Zdroj source лампа	příkon input [W]	objímka socket патрон
--------------------	--------------------	--------------------------	------------------------	-----------------------------

EVG

44103	E-25USZ21/421/L100		2x18	2x18
-------	--------------------	--	------	------

DIM

44104	ES-25USZ21/421/L100 1-10V		2x18	2xG24q2
44105	ES-25USZ21/421/L100 DALI		2x18	2xG24q2

LED IP41

code код 3000	code код 4000	typ type тип	[lm] 3000K	[lm] 4000K	příkon input [W]	záruka Guarantee [years]
57153	57653	LED-5L02A07USZ21/421/L100 .000	2300	2460	24	5*

DIM

57154	57654	LED-5L02A07US21/421/L100 DALI .000	2300	2460	24	5
-------	-------	------------------------------------	------	------	----	---

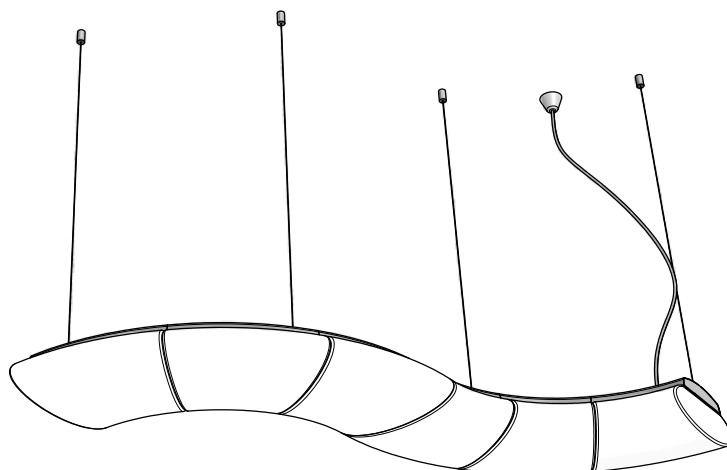
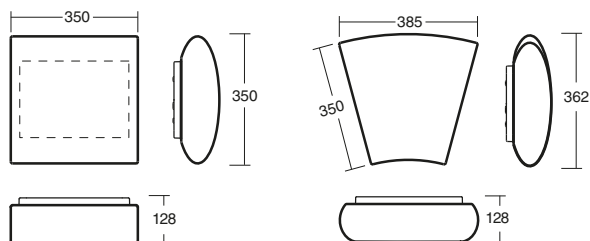

* viz str. ,See, см. страница, Siehe, voir : 204



I.

STOLNÍ LAMPY S OPÁLOVÝMI STÍNÍTKY
TABLE LAMPS WITH OPAL SHADES
НАСТОЛЬНЫЕ ЛАМПЫ С ОПАЛОВЫМИ СВЕТОРАСВЕИТЕЛЯМИ
TISCHLAMPEN MIT OPALGLASABDECKUNGEN
LAMPE DE BUREAU AVEC ABAT-JOUR OPALE

ACTOR BIANCA 1,2,3,4 ADELE

CE 230V IP40

POPIS SVÍTIDEL

Svítidla tvoří kovová nebo polykarbonátová základna, skleněné stínítko a šňůrový přívod s průchozím vypínačem

- ocelový plech upravený práškovým lakováním
 - mosazný plech
 - polykarbonát
- Stínítko
- třívrstvé, ručně vyráběné sklo TRIPLEX OPÁL s matovaným povrchem

DESCRIPTION OF THE LIGHTING FITTINGS

The lighting consist of the metal or polycarbonate base, glass shade and cord supply with pass-switch

- Base
- sheet steel modified by powder paint
 - Brass steel
 - polycarbonate
- Shade
- three layers, hand blown glass TRIPLEX OPAL with matt surface

ОПИСАНИЕ СВЕТИЛЬНИКОВ

Светильники состоят из металлического основания, стеклянного светорассеивателя и электрического кабеля с выключателем

- Основание
- металлическое основание обработанное порошковой краской
 - латунное основание
 - поликарбонат
- Светорассеиватель
- трехслойное, изготовленное вручную стекло TRIPLEX OPÁL с матированной поверхностью

BESCHREIBUNG DER LEUCHTEN

Die Leuchten bestehen aus der Metall- oder Polykarbonatgrundplatte, der Glasabdeckung und der Zuleitungsschnur mit Durchgangsschalter

- Grundplatte
- Stahlblech mit Pulverlackierung
 - Messingblech
 - Polykarbonate
- Abdeckung
- mundgeblasenes Dreischichtglas TRIPLEX OPAL

DESCRIPTION DES LUMINAIRES

Les luminaires se composent d'une base en métallique ou polycarbonate, d'un abat-jour en verre et d'un cordon d'alimentation avec interrupteur

- Base
- tôle d'acier enduit de poudre modifiée
 - Feuille de laiton
 - polycarbonate
- Abat-jour
- verre en trois couches fait artisanalement TRIPLEX OPAL avec une surface mate



Barevné provedení, Colour versions, Цвет, Farbliche Ausführung, Couleurs

typ/type/ тип barva/colour/цвет/ Couleur/Farbe

B - bílá, white, белый, Weiß, Blanc

S - stříbrná, silver, серебристый, Silber, argent

MS - mosaz, brass, латунь, Messing, laiton

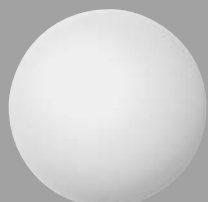

ACTOR B IP40 □

kód code код	typ type тип	Zdroj source лампа	příkon input [W]	objímka socket патрон
58000	SL1/251 B		60	E27

NOVINKA/NEW



Ø 220 mm

ACTOR S IP40 □

kód code код	typ type тип	Zdroj source лампа	příkon input [W]	objímka socket патрон
58001	SL1/251 S		60	E27

NOVINKA/NEW



Ø 220 mm

ACTOR MS IP40 □

kód code код	typ type тип	Zdroj source лампа	příkon input [W]	objímka socket патрон
58002	SL1/251 MS		60	E27

NOVINKA/NEW



Ø 220 mm

Náhradní stínítka/spare shade/запасное стекло

Kód/code/код	Typ/Type/тип	D [mm]
20062	251	220

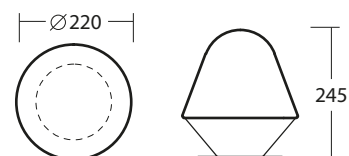

BIANCA

NOVINKA/NEW



Ø 200 mm

Náhradní stínítko/spare shade/запасное стекло

Kód/code/код	Typ/Type/тип	D [mm]
20096	292	200

BIANCA 1 IP40

kód code код	typ type тип	Zdroj source лампа	příkon input [W]	objímka socket патрон
58003	IN-12BD1/292		25	E27

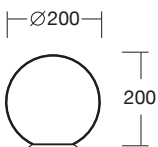

NOVINKA/NEW



Ø 250 mm

Náhradní stínítko/spare shade/запасное стекло

Kód/code/код	Typ/Type/тип	D [mm]
20097	293	250

BIANCA 2 IP40

kód code код	typ type тип	Zdroj source лампа	příkon input [W]	objímka socket патрон
58004	IN-12BD1/293		40	E27

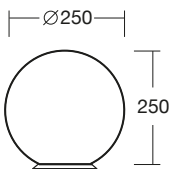

NOVINKA/NEW



Ø 300 mm

Náhradní stínítko/spare shade/запасное стекло

Kód/code/код	Typ/Type/тип	D [mm]
20098	294	300

BIANCA 3 IP40

kód code код	typ type тип	Zdroj source лампа	příkon input [W]	objímka socket патрон
58005	IN-12BD1/294		60	E27

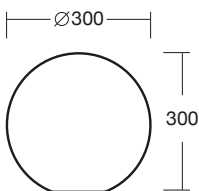

ADELE B IP40

kód code код	typ type тип	Zdroj source лампа	příkon input [W]	objímka socket патрон
58010	SL3/100 B		60	E27

NOVINKA/NEW



Ø 120 mm

ADELE S IP40

kód code код	typ type тип	Zdroj source лампа	příkon input [W]	objímka socket патрон
58011	SL3/100 S		60	E27

NOVINKA/NEW



Ø 120 mm

ADELE MS IP40

kód code код	typ type тип	Zdroj source лампа	příkon input [W]	objímka socket патрон
58012	SL3/100 MS		60	E27

NOVINKA/NEW



Ø 120 mm

Náhradní stínítka/spare shade/запасное стекло

Kód/code/код	Typ/Type/тип	a x b/размер [mm]
20099	100	120

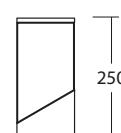
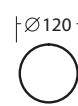

II.

SVÍTIDLA S PLASTOVÝMI STÍNÍTKY
 LIGHTING WITH PLASTIC SHADES
 СВЕТИЛЬНИКИ С ПЛАСТИКОВЫМИ СВЕТОРАСSEИВАТЕЛЯМИ
 LEUCHTEN MIT KUNSTSTOFFABDECKUNGEN
 LUMINAIRE AVEC ABAT-JOUR EN OPAL PLASTIQUE

TITAN 1A,1,2,3,4,5 150-157

DELIA 1,2,3 158-163

TILIA 1,2 164-167

VICIA 168

TITAN 13 170-171

VEGA 172-173

ISIS 3,4 176-183

ISIS L3,4 / ISIS S3,4

TITAN T 2,3 184-186

DELIA T 2,3 187-188

VICIA T 189

TITAN L 4,5 190-191

VELA L 192-193

ELEKTRA 1,2 196

ELEKTRA 3,3K,3L 198

ELEKTRA 4,5 200

ELEKTRA 6 202

META 204

A.
 PŘÍSAZENÁ SVÍTIDLA
 SURFACE MOUNTED LAMPS
 НАКЛАДНЫЕ СВЕТИЛЬНИКИ
 WAND- UND DECKENLEUCHTEN
 APPLICATION DE LUMINAIRES



TITAN 1A,1,2,3,4,5



DELIA 1,2,3



TILIA 1,2



VICIA



TITAN 13

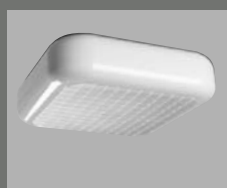

VEGA

B.
 ZÁVĚSNÁ SVÍTIDLA
 PENDANT LIGHTING FITTINGS
 ПОДВЕСНЫЕ СВЕТИЛЬНИКИ
 PENDELLEUCHTEN
 LUMINAIRE SUSPENDU



ISIS 3,4 / ISIS L3,4 / ISIS S3,4



TITAN T 2,3



DELIA T 2,3



VICIA T



TITAN L 4,5

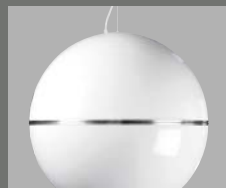

VELA L

C.
 PRŮMYSLOVÁ SVÍTIDLA
 INDUSTRIAL LIGHTING
 ПРОМЫШЛЕННЫЕ
 СВЕТИЛЬНИКИ
 INDUSTRIELLEUCHTEN
 LUMINAIRE INDUSTRIEL



ELEKTRA 1,2



ELEKTRA 3,3K,3L



ELEKTRA 4,5



ELEKTRA 6



META, META L

CZ POPIS SVÍTIDEL:

Svítlidla jsou tvořena kovovou nebo plastovou monturou a plastovým stínítkem	
Držení závěsných svítidel je provedeno lanem, kabelem, nebo trubkou o průměru 10mm.	
Montury	- ocelový plech upravený práškovým lakováním v provedení IP41, IP44 - polykarbonátový výlisek – IP65 ☐ - polypropylenový výlisek – IP53, IP54 ☐
Závěs	- tyčový, lankový, třílankový, kabelový
Stínítka	- opalový polykarbonát. ODOLNOST PROTI NÁRAZŮM JE MIN 44Nm (IK10) - opalový polymethylmetakrylát (PMMA) - opalový polyetylen (PE)
Držení stínítka	- sklápovací držáky, šroubové, bajonetové
Montáž	- na stěnu nebo na strop
Použití	- bytová výstavba, (pokojy, koupelny, chodby, schodiště), hotely, školy, společenské prostory, venkovní osvětlení

LED**Standardní nabídka - 2 řady LED modulů s různým výkonem a různou dobou záruky:**

- Svítlidla s moduly **L11A07, L12A07, L13A07, L14A07** - 3 roky záruka

- Svítlidla s moduly **L02A07 a L02A10** - 5let záruka

*** Nadstandardní nabídka (na zakázku):**

- Svítlidla **LED-L02A07...TOP a LED-L02A10...TOP** - 7let záruka

Upozornění: I tyto záruky se vztahují pouze na proudové zdroje a LED moduly

Teploty chromatičnosti LED modulů L11, L12, L13, L14

3000K - teplá bílá, Ra>80

4000K - neutrální bílá, Ra>80

Teploty chromatičnosti LED modulů L02A07, L02A10

3000K - teplá bílá, Ra>80

4000K - neutrální bílá, Ra>70

EN DESCRIPTION OF THE LIGHTING FITTINGS:

The lighting fittings consist of the metal, plastic fixture and the plastic shade	
Pendant lighting are attached by wire, cable or by steel bar Ø 10 mm	
Fixtures	- sheet steel modified by powder painting – IP 41, IP 44 - polycarbonate moulding – IP65 ☐ - polypropylene moulding – IP 53, IP 54 ☐
Pendant	- bar, wire, 3 – wires, cable
Shades	- opal polycarbonate, SHOCK RESISTANCE IS MIN 44 Nm (IK10) - opal polymethylmethacrylate (PMMA) - opal polyethylene (PE)
Shade attachment	- with folding two-step clamp holders, bayonet, screws
Assembly	- to the ceiling or on the wall
Applications	- housing construction (rooms, bathrooms, corridors, stairs), schools, cultural premises, outdoor premises

LED**Standard offer – 2 series LED modules with different power and life guarantee:**

- lighting with modules **L11A07, L12A07, L13A07, L14A07** - 3 year of guarantee

- lighting with modules **L02A07 a L02A10** - 5 years of guarantee

*** Above-standard (on request):**

- Lighting **LED-L02A07...TOP and LED-L02A10...TOP** - 7 years of guarantee

Notice: These guarantees are only for power supply and LED modules

Temperatures of chromacity of LED modules L11, L12, L13, L14

3000 K - warm white with colour rendering index CRI>80

4000 K - neutral white with colour rendering index CRI>80

Temperatures of chromacity of LED modules L02A07, L02A10

3000 K - warm white with colour rendering index CRI>80

4000 K - neutral white with colour rendering index CRI>70

RUS ОПИСАНИЕ СВЕТИЛЬНИКОВ:

Накладные светильники состоят из металлического или пластикового основания и пластикового светорассеивателя	
Крепление подвесных светильников осуществляется с помощью гибкого подвеса, кабеля или жесткого подвеса диаметром 10мм.	
Основание	- металлическое основание обработанное порошковой краской – IP41, IP44 - прессованное основание из поликарбоната – IP65 ☐ - прессованное основание из полипропилена – IP53, IP54 ☐
Подвес	- жесткий, один трос, три троса, кабель
Светорассеиватель	- опаловый поликарбонат. УДАРОПРОЧНОСТЬ СОСТАВЛЯЕТ КАК МИНИМУМ 44Nm (IK10) - опаловый полиметилакрилат (PMMA) - опаловый полиэтилен (PE)
Крепление рассеивателя	- откидные фиксаторы – защелки, винты, резьбовое соединение «байонет»
Установка	- на стену или на потолок
Назначение	- жилые помещения, гостиницы, школы (комнаты, корридоры, ванные, лестницы), общественные помещения, наружное освещение

LED**Стандартное предложение - 2 группы LED модулей различной мощности и различной длительностью гарантийного срока:**

Стандартное предложение - 2 группы LED модулей различной мощности и различным гарантийным сроком:

- Светильники с модулями **L11A07, L12A07, L13A07, L14A07** - гарантия 3 года

- Светильники с модулями **L02A07 и L02A10** - гарантия 5 лет

* Нестандартное предложение (под заказ):

- Светильники **LED-L02A07...TOP** и **LED-L02A10...TOP** - гарантия 7 лет

Внимание: Данный гарантийный срок распространяется исключительно на источники тока и LED модули

Индекс цветопередачи LED модулей L11, L12, L13, L14

3000K - теплый белый, Ra >80

4000K - нейтральный белый, Ra >80

Индекс цветопередачи LED модулей L02A07, L02A10

3000K - теплый белый, Ra >80

4000K - нейтральный белый, Ra >70

DE BESCHREIBUNG DER LEUCHTEN:

Die Leuchten bestehen aus einer Stahlblechmatur oder Polykarbonatarmatur und einer Kunststoffabdeckung.	
Die Aufhängung der Hängeleuchten erfolgt mit einem Seil, Kabel oder einer Stange mit einem Durchmesser von 10 mm.	
Armaturen	- Stahlblech mit Pulverlack beschichtet IP41, IP 44 - Polykarbonatpressteil – IP 65 ☐ - Polypropylenpressteil – IP 53, IP 54 ☐
Aufhängung	- Stangen-, Seil-, Dreiseil- und Kabelaufhängung
Abdeckungen	- Opalpolykarbonat, STOBESTÄNDIGKEIT BETRÄGT MIN 44Nm (IK 10) - Opal Polymethylmethakrylat (PMMA) - Opal Polyethylen (PE)
Halterung der Abdeckscheibe	- klappbare Halterungen, Schraubenhalterung, Bajonettverschluss
Montage	- als Wand- oder Deckenleuchten
Einsatz	- Wohnungsbau (Zimmer, Badezimmer, Flure, Treppen), Schulgebäude, Gemeinschaftsräume, Außenbeleuchtung

LED**Standardangebot - 2 Reihen von LED Modulen mit unterschiedlicher Leistung und Garantiezeit**

- Leuchten mit Modulen **L11A07, L12A07, L13A07, L14A07** - 3 Jahre Garantie

- Leuchten mit Modulen **L02A07 a L02A10** - 5 Jahre Garantie

* Sonderangebot (auf Bestellung)

Leuchten **LED-L02A07...TOP** und **LED-L02A10...TOP** - 7 Jahre Garantie

Hinweis: Diese Garantien beziehen sich nur auf Stromquellen und LED-Module

Chrominanztemperatur der LED Module L11, L12, L13, L14

3000 K - Warmweiß mit Farbwiedergabeindex CRI>80

4000 K - Neutralweiß mit Farbwiedergabeindex CRI>80

Chrominanztemperatur der LED Module L02A07, L02A10

3000 K - Warmweiß mit Farbwiedergabeindex CRI>80

4000 K - Neutralweiß mit Farbwiedergabeindex CRI>70

F DESCRIPTION DES LUMINAIRES

Les luminaires d'intérieur se composent d'une monture métallique ou en plastique et d'un abat-jour en plastique

La fixation des luminaires suspendus réalisée par un fil, un câble ou une tige d'un diamètre de 10 mm

Monture	- tôle en acier traitée par vernissage par pulvérisation – IP 41, IP 44 - polycarbonate moulé – IP 65 - polypropylène moulé - IP 53, IP54
Suspension	- tige, fils, câbles de trois fils
Abat-jour	- polykarbonat opale – RÉSISTANCE AUX CHOCS D'UN MIN DE 44Nm (IK10) - polyméthylméthacrylate opale (PMMA) - polyéthylène opale (PE)
Fixation de l'abat-jour	- supports clips, par vis, par baielette
Montage	- sur un plafond ou sur un mur
Utilisation	- immeubles, (chambres, salle de bains, couloirs, escaliers), hôtels, écoles, locaux publics, extérieurs

LED**L'offre standard - 2 séries de modules de LED à puissances différentes et à durées de garantie variables**

- Luminaires avec les modules **L11A07, L12A07, L13A07, L14A07** - 3 ans de garantie

- Luminaires avec les modules **L02A07 a L02A10** - 5 ans de garantie

Offre haut de gamme (personnalisées)

- Luminaires **LED-L02A07...TOP** et **LED-L02A10...TOP** - 7 ans de garantie

Remarque: Ces garanties ne s'appliquent que pour les luminaires à source de courant et les modules LED

Variantes de couleur LED modules L11, L12, L13, L14

3000 K - blanc profond avec un indice de couleur CRI>80

4000 K - blanc neuter avec un indice de couleur CRI>80

Variantes de couleur LED modules L02A07, L02A10

3000 K - blanc profond avec un indice de couleur CRI>80

4000 K - blanc neuter avec un indice de couleur CRI>70

TITAN 1A,1,2,3,4,5

DELIA 1,2,3

TILIA 1,2

VICIA



POPIS SVÍTIDEL

Svítidlo tvoří montura z kovu a stínítko z polykarbonátu nebo PMMA	
Montura	- ocelový plech upravený práškovým lakováním - IP44, IP20
Stínítko	- opalový polykarbonát - ODOLNOST PROTI NÁRAZU JE min 44 Nm (IK10) - opalový polymethylmetakrylát (PMMA)
Držení stínítka	- sklapovací držáky
Montáž	- na stěnu nebo na strop
Použití	- bytová výstavba, školní budovy, společenské prostory, venkovní osvětlení

DESCRIPTION OF THE LIGHTING FITTINGS

The lighting fittings consist of the metal fixture and the polycarbonate or PMMA shade	
Fixture	- sheet steel modified by powder painting - IP 44, IP20
Shade	- opal polycarbonate, SHOCK RESISTANCE IS MIN 44 Nm (IK10) - opal polymethylmetacrylate (PMMA)
Shade attachment	- with folding two-step clamp holders
Assembly	- to the ceiling or on the wall
Applications	- housing construction, schools, cultural premises, outdoor premises

ОПИСАНИЕ СВЕТИЛЬНИКОВ

Светильник состоит из металлического основания и светорассеивателя из поликарбоната или PMMA	
Основание	- металлическое основание, обработанное, порошковой краской - IP44, IP20
Светорассеиватель	- опаловый поликарбонат - УДАРОПРОЧНОСТЬ СОСТАВЛЯЕТ КАК МИНИМУМ 44 Nm (IK10) - опаловый полиметилакрилат (PMMA)
Крепление рассеивателя	- откидные фиксаторы - защелки
Установка	- на стену или на потолок
Назначение	- жилые помещения, гостиницы, школы, общественные помещения, наружное освещение

BESCHREIBUNG DER LEUCHTEN

Die Leuchten bestehen aus einer Stahlblecharmatur und einer Polykarbonat- oder PMMA Abdeckung.	
Armatur	- Stahlblech mit Pulverlack beschichtet IP 44, IP20
Abdeckung	- Opalpolykarbonat, STOBBESTÄNDIGKEIT BETRÄGT MIN 44Nm (IK10) - opal Polymethylmethakrylat (PMMA)
Halterung der Abdeckscheibe	- klappbare Halterungen
Montage	- als Wand- oder Deckenleuchten
Einsatz	- Wohnungsbau, Schulgebäude, Gemeinschaftsräume, Außenbeleuchtung

DESCRIPTION DES LUMINAIRES



Le luminaire se compose d'une monture métallique et d'un abat-jour en polycarbonate ou en PMMA	
Monture	- tôle en acier traitée par vernissage par pulvérisation - IP 44, IP20
Abat-jour	- polycarbonate opale - RESISTANCE AUX CHOCS D'UN MIN DE 44Nm (IK10) - polymethylmethacrylate opale (PMMA)
Fixation de l'abat-jour	- supports clips à deux positions
Montage	- sur un plafond ou sur un mur
Utilisation	- immeubles, écoles, locaux publics, extérieurs



TITAN 1A IP44

Kód code код	typ type тип	Zdroj source лампа	přikon input [W]	objímka socket патрон	T [h]
--------------------	--------------------	--------------------------	------------------------	-----------------------------	----------

POLYKARBONÁTOVÉ STÍNÍTKO / POLYCARBONATE SHADE

A					
56050	IN-12KN32/PC03		60	E27	
EVG					
56051	E-14KN32/PC03		13	G24q1	
N					
56052	NZ-7/PC03		7	2G7	1,0



LED IP44

Kód code код	kód code код	typ type тип	[lm] 3000K	[lm] 4000K	přikon input [W]	T [h]	záruka Guarantee [years]
47277	47777	LED-1L12A07KN32/PC03.000	980	980	11		3
47278	47778	LED-3L02A07KN32/PC03.000	1380	1470	15		5
N							
-	49002	LED-NZ1W/PC03 4000	-	100	1,0	3,0	3

TITAN 1A IP44

Kód code код	typ type тип	Zdroj source лампа	přikon input [W]	objímka socket патрон	T [h]
--------------------	--------------------	--------------------------	------------------------	-----------------------------	----------

PMMA STÍNÍTKO / PMMA SHADE

A					
56053	IN-12KN32/PM03		40	E27	
EVG					
56054	E-14KN32/PM03		13	G24q1	
N					
56055	NZ-7/PM03		7	2G7	1,0

LED IP44

Kód code код	kód code код	typ type тип	[lm] 3000K	[lm] 4000K	přikon input [W]	T [h]	záruka Guarantee [years]
47279	47779	LED-1L12A07KN32/PM03.000	980	980	11		3
47280	47780	LED-3L02A07KN32/PM03.000	1380	1470	15		5
N							
-	49005	LED-NZ1W/PM03 4000	-	100	1,0	3,0	3



PC Náhradní stínítko/spare shade/запасное стекло

Kód/code/код	Typ/Type/тип	D [mm]
20513	PC03	220

PMMA Náhradní stínítko/spare shade/запасное стекло

Kód/code/код	Typ/Type/тип	D [mm]
20514	PM03	220

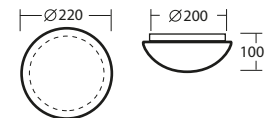

TITAN 1



Ø 300 mm

PC Náhradní stínítko/spare shade/запасное стекло

Kód/code/код	Typ/Type/тип	D [mm]
20504	PC06	300

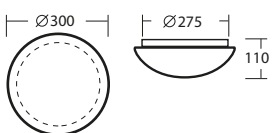

TITAN 1 IP44

Kód code код	typ type тип	Zdroj source лампа	příkon input [W]	objímka socket патрон	T [h]
--------------------	--------------------	--------------------------	------------------------	-----------------------------	----------

POLYKARBONÁTOVÉ STÍNÍTKO / POLYCARBONATE SHADE

A					
56000	IN-12KN62/PC06		60	E27	
EVG					
56001	E-16KN62/PC06		26	G24q3	
56002	E-101KN62/PC06		22	2GX13	
56040	E-25KN62/PC06		2x18	2xG24q2	
S					
46127	IN-12KN62/PC06 HF		60	E27	
46187	E-16KN62/PC06 HF		26	G24q3	
N					
56003	NZ-13/PC06		13	G24q1	1,0
NE					
42684	NK-E-26/PC06		26	G24q3	1,0

LED IP44

Kód code код	kód code код	typ type тип	[lm]		příkon input [W]	T [h]	záruka Guarantee [years]
			3000K	4000K			
47255	47755	LED-1L13A07KN62/PC06.000	1480	1480	16		3
47256	47756	LED-1L14A07KN62/PC06.000	1970	1970	21		3
47257	47757	LED-4L02A10KN62/PC06.000	2460	2630	30		5*
DIM							
47258	47758	LED-4L02A10KN62/PC06 1-10V.000	2460	2630	30		5
47259	47759	LED-4L02A10KN62/PC06 DALI.000	2460	2630	30		5
S							
47260	47760	LED-1L13A07KN62/PC06 HF.000	1480	1480	16		3
47261	47761	LED-4L02A10KN62/PC06 HF.000	2460	2630	30		5*
NE							
47262	47762	LED-1L13A07KN62/PC06/NK1W.000	1480	1480	16	3,0	3
47263	47763	LED-4L02A10KN62/PC06/NK1W.000	2460	2630	30	3,0	5*
NES							
47264	47764	LED-1L13A07KN62/PC06/NK1W HF.000	1480	1480	16	3,0	3
47265	47765	LED-4L02A10KN62/PC06/NK1W HF.000	2460	2630	30	3,0	5



TITAN 1 IP44

Kód code код	typ type тип	Zdroj source лампа	přikon input [W]	objímka socket патрон	T [h]
--------------------	--------------------	--------------------------	------------------------	-----------------------------	----------



PMMA STÍNÍTKO / PMMA SHADE

A					
56006	IN-12KN62/PM06		40	E27	

EVG

56007	E-16KN62/PM06		26	G24q3	
56008	E-101KN62/PM06		22	2GX13	
56041	E-25KN62/PM06		2x18	2xG24q2	

S

46128	IN-12KN62/PM06 HF		40	E27	
46188	E-16KN62/PM06 HF		26	G24q3	

N

56009	NZ-13/PM06		13	G24q1	1,0
-------	------------	---	----	-------	-----

NE

46299	NK-E-26/PM06		26	G24q3	1,0
-------	--------------	---	----	-------	-----

LED IP44

Kód code код	kód code код	typ type тип	[lm] 3000K	[lm] 4000K	přikon input [W]	T [h]	záruka Guarantee [years]
47266	47766	LED-1L13A07KN62/PM06.000	1480	1480	16		3
47267	47767	LED-1L14A07KN62/PM06.000	1970	1970	21		3
47268	47768	LED-4L02A10KN62/PM06.000	2460	2630	30		5*

DIM

47269	47769	LED-4L02A10KN62/PM06 1-10V.000	2460	2630	30		5
47270	47770	LED-4L02A10KN62/PM06 DALI.000	2460	2630	30		5

S

47271	47771	LED-1L13A07KN62/PM06 HF.000	1480	1480	16		3
47272	47772	LED-4L02A10KN62/PM06 HF.000	2460	2630	30		5*

NE

47273	47773	LED-1L13A07KN62/PM06/NK1W.000	1480	1480	16	3,0	3
47274	47774	LED-4L02A10KN62/PM06/NK1W.000	2460	2630	30	3,0	5*

NES

47275	47775	LED-1L13A07KN62/PM06/NK1W HF.000	1480	1480	16	3,0	3
47276	47776	LED-4L02A10KN62/PM06/NK1W HF.000	2460	2630	30	3,0	5



Ø 300 mm

PMMA Náhradní stínítko/spare shade/запасное стекло

Kód/code/код	Typ/Type/тип	D [mm]
20507	PM06	300

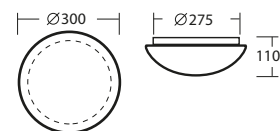

TITAN 2



Ø 400 mm

PC Náhradní stínítko/spare shade/запасное стекло

Kód/code/код	Typ/Type/тип	D [mm]
20505	PC08	400

PMMA Náhradní stínítko/spare shade/запасное стекло

Kód/code/код	Typ/Type/тип	D [mm]
20508	PM08	400

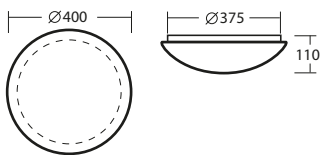

TITAN 2 IP44

Kód code код	typ type тип	Zdroj source лампа	příkon input [W]	objímka socket патрон	T [h]
--------------	--------------	--------------------	------------------	-----------------------	-------

POLYKARBONÁTOVÉ STÍNÍTKO / POLYCARBONATE SHADE

A					
56012	IN-22KN83/PC08		2x60	2xE27	
EVG					
42669	E-25KN83/PC08		2x18	2xG24q2	
56013	E-26KN83/PC08		2x26	2xG24q3	
56014	E-102KN83/PC08		40	2GX13	
DIM					
42583	ES-26KN83/PC08 1-10V		2x26	2xG24q3	
42585	ES-26KN83/PC08 DALI		2x26	2xG24q3	
S					
46129	IN-22KN83/PC08 HF		2x40	E27	
46189	E-16KN83/PC08 HF		26	G24q3	
NE					
56016	NK-E-26/PC08		26	G24q3	1,0
46213	NKC-226/13/PC08		2x26	2xG24q3	1,0

LED IP44

Kód code код	kód code код	typ type тип	[lm] 3000K	[lm] 4000K	příkon input [W]	T [h]	záruka Guarantee [years]
50200	50700	LED-4L11A07KN83/PC08.000	2950	2950	30		3
50201	50701	LED-6L02A10KN83/PC08.000	3700	3940	43		5*
DIM							
50202	50702	LED-6L02A10KN83/PC08 1-10V.000	3700	3940	43		5
50203	50703	LED-6L02A10KN83/PC08 DALI.000	3700	3940	43		5
S							
50204	50704	LED-4L11A07KN83/PC08 HF.000	2950	2950	30		3
50205	50705	LED-6L02A10KN83/PC08 HF.000	3700	3940	43		5*
NE							
50206	50706	LED-4L11A07KN83/PC08/NK1W.000	2950	2950	30	3,0	3
50207	50707	LED-6L02A10KN83/PC08/NK1W.000	3700	3940	43	3,0	5*

TITAN 2 IP44

code	typ	source	[W]	socket	T/[h]
------	-----	--------	-----	--------	-------

PMMA STÍNÍTKO / PMMA SHADE

A					
56018	IN-22KN83/PM08		2x40	2xE27	
EVG					
44022	E-25KN83/PM08		2x18	2xG24q2	
56019	E-26KN83/PM08		2x26	2xG24q3	
56020	E-102KN83/PM08		40	2GX13	
DIM					
42586	ES-26KN83/PM08 1-10V		2x26	2xG24q3	
42588	ES-26KN83/PM08 DALI		2x26	2xG24q3	
S					
46130	IN-22KN83/PM08 HF		2x40	E27	
46191	E-16KN83/PM08 HF		26	G24q3	
NE					
56022	NK-E-26/PM08		26	G24q3	1,0
46214	NKC-226/13/PM08		2x26	2xG24q3	1,0













LED IP44

code 3000K	code 4000K	typ	[lm] 3000K	[lm] 4000K	[W]	T [h]	Guarantee [years]
50208	50708	LED-4L11A07KN83/PM08.000	2950	2950	30		3
50209	50701	LED-6L02A10KN83/PM08.000	3700	3940	43		5*
DIM							
50210	50710	LED-6L02A10KN83/PM08 1-10V.000	3700	3940	43		5
50211	50711	LED-6L02A10KN83/PM08 DALI.000	3700	3940	43		5
S							
50212	50712	LED-4L11A07KN83/PM08 HF.000	2950	2950	30		3
50213	50713	LED-6L02A10KN83/PM08 HF.000	3700	3940	43		5*
NE							
50214	50714	LED-4L11A07KN83/PM08/NK1W.000	2950	2950	30	3,0	3
50215	50715	LED-6L02A10KN83/PM08/NK1W.000	3700	3940	43	3,0	5*

TITAN 3 IP44

Kód code код	typ type тип	Zdroj source лампа	příkon input [W]	objímka socket патрон	T [h]
--------------------	--------------------	--------------------------	------------------------	-----------------------------	----------

POLYKARBONÁTOVÉ STÍNÍTKO / POLYCARBONATE SHADE

A					
56024	IN-32KN94/PC09		3x60	3xE27	
EVG					
44640	E-26KN94/PC09 32W		2x32	2xGX24q3	
56025	E-27KN94/PC09		2x36	2xG10	
44641	E-46KN94/PC09		4x26	4xG24q3	
56026	E-204KN94/PC09		22+40	2xGX13	
DIM					
42589	ES-46KN94/PC09 1-10V		4x26	4xG24q3	
42591	ES-46KN94/PC09 DALI		4x26	4xG24q3	
S					
46131	IN-32KN94/PC09 HF		3x40	3xE27	
46192	E-17KN94/PC09 HF		36	2G10	
NE					
56028	NK-E-36/PC09		36	2G10	1,0
46215	NKC-226/13/PC09		2x26	2xG24q3	1,0
44642	NKC-232/16/PC09		2x32	2xGX24q3	1,0

LED IP44

Kód code код	kód code код	typ type тип	[lm]	[lm]	příkon input [W]	T [h]	záruka Guarantee [years]
			3000K	4000K			
50216	50716	LED-4L12A07KN94/PC09.000	3940	3940	41		3
50217	50717	LED-8L02A10KN94/PC09.000	4930	5250	58		5*
DIM							
50218	50718	LED-8L02A10KN94/PC09 1-10V.000	4930	5250	58		5
50219	50719	LED-8L02A10KN94/PC09 DALI.000	3930	5250	58		5
S							
50220	50720	LED-4L12A07KN94/PC09 HF.000	3940	3940	41		3
50221	50721	LED-8L02A10KN94/PC09 HF.000	4930	5250	58		5*
NE							
50222	50722	LED-4L12A07KN94/PC09/NK1W.000	3940	3940	41	3,0	3
50223	50723	LED-8L02A10KN94/PC09/NK1W.000	4930	5250	58	3,0	5*



Ø 500 mm

PC Náhradní stínítko/spare shade/запасное стекло

Kód/code/код	Typ/Type/тип	D [mm]
20506	PC09	500

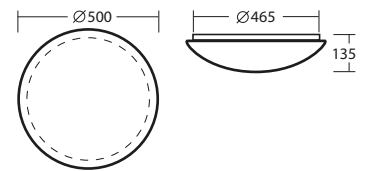

TITAN 3



Ø 500 mm

PMMA Náhradní stínítko/spare shade/запасное стекло

Kód/code/код	Typ/Type/тип	D [mm]
20509	PM09	500

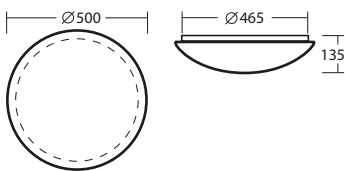

TITAN 3 IP44

Kód code код	typ type тип	Zdroj source лампа	příkon input [W]	objímka socket патрон	T [h]
--------------------	--------------------	--------------------------	------------------------	-----------------------------	----------

PMMA STÍNÍTKO / PMMA SHADE

A					
56030	IN-32KN94/PM09		3x40	3xE27	
EVG					
44643	E-26KN94/PM09 32W		2x32	2xGX24q3	
56031	E-27KN94/PM09		2x36	2x2G10	
56032	E-204KN94/PM09		22+40	2x2GX13	
DIM					
42592	ES-27KN94/PM09 1-10V		2x36	2x2G10	
42594	ES-27KN94/PM09 DALI		2x36	2x2G10	
S					
46132	IN-32KN94/PM09 HF		3x40	3xE27	
46193	E-17KN94/PM09 HF		36	2G10	
NE					
56034	NK-E-36/PM09		36	2G10	1,0
46216	NKC-226/13/PM09		2x26	2xG24q3	1,0
44644	NKC-232/16/PM09		2x32	2xGX24q3	1,0

LED IP44

Kód code код	kód code код	typ type тип	[lm] 3000K	[lm] 4000K	příkon input [W]	T [h]	záruka Guarantee [years]
50224	50724	LED-4L12A07KN94/PM09.000	3940	3940	41		3
50225	50725	LED-8L02A10KN94/PM09.000	4930	5250	58		5*
DIM							
50226	50726	LED-8L02A10KN94/PM09 1-10V.000	4930	5250	58		5
50227	50727	LED-8L02A10KN94/PM09 DALI.000	4930	5250	58		5
S							
50228	50728	LED-4L12A07KN94/PM09 HF.000	3940	3940	41		3
50229	50729	LED-8L02A10KN94/PM09 HF.000	4930	5250	58		5*
NE							
50230	50730	LED-4L12A07KN94/PM09/NK1W.000	3940	3940	41	3,0	3
50231	50731	LED-8L02A10KN94/PM09/NK1W.000	4930	5250	58	3,0	5*



TITAN 4

TITAN 4 IP44

Kód code код	typ type тип	Zdroj source лампа	příkon input [W]	objímka socket патрон	T [h]
--------------------	--------------------	--------------------------	------------------------	-----------------------------	----------

PMMA STÍNÍTKO / PMMA SHADE

A					
56056	IN-42KN10/PM10		4x40	4xE27	

EVG					
56057	E-48KN10/PM10		4x42	4xGX24q4	
56058	E-47KN10/PM10		4x36	4x2G10	

DIM					
56059	ES-47KN10/PM10 1-10V		4x36	4x2G10	
56060	ES-47KN10/PM10 DALI		4x36	4x2G10	

LED IP44

Kód code код	kód code код	typ type тип	[lm]		příkon input [W]	T [h]	záruka Guarantee [years]
			3000K	4000K			
50232	50732	LED-4L13A07KN10/PM10.000	5900	5900	59		3
50233	50733	LED-12L02A10KN10/PM10.000	7390	7880	86		5*

DIM							
50235	50735	LED-12L02A10KN10/PM10 1-10V.000	7390	7880	86		5
50236	50736	LED-12L02A10KN10/PM10 DALI.000	7390	7880	86		5



Ø 650 mm

PMMA Náhradní stínítko/spare shade/запасное стекло

Kód/code/код	Typ/Type/тип	D [mm]
20515	PM10	650

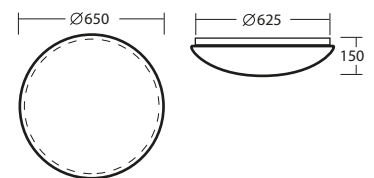



TITAN 5



TITAN 5 IP44

Kód code код	typ type тип	Zdroj source лампа	příkon input [W]	objímka socket патрон	T [h]
--------------------	--------------------	--------------------------	------------------------	-----------------------------	----------

PMMA STÍNÍTKO / PMMA SHADE

A					
56061	IN-62KN11/PM11		6x40	6xE27	

EVG					
56062	E-66KN11/PM11		6x24	G5	
56063	E-67KN11/PM11		6x36	6x2G10	

DIM					
56064	ES-67KN11/PM11 1-10V		6x36	6x2G10	
56065	ES-67KN11/PM11 DALI		6x36	6x2G10	

LED IP44

Kód code код	kód code код	typ type тип	[lm]		příkon input [W]	T [h]	záruka Guarantee [years]
			3000K	4000K			
50237	50737	LED-6L13A07KN11/PM11.000	8860	8860	88		3
50238	50738	LED-16L02A10KN11/PM11.000	9860	10510	129		5*

DIM							
50240	50740	LED-16L02A10KN11/PM11 1-10V.000	9860	10510	129		5
50241	50741	LED-16L02A10KN11/PM11 DALI.000	9860	10510	129		5



Ø 900 mm

PMMA Náhradní stínítko/spare shade/запасное стекло

Kód/code/код	Typ/Type/тип	D [mm]
20516	PM11	900

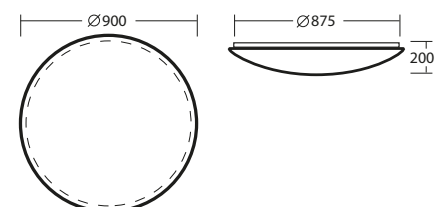

DELIA 1

NOVINKA/NEW



Ø 300 mm

Náhradní stínítko/spare shade/запасное стекло

Kód/code/код	Typ/Type/тип	D [mm]
20520	PC22	300

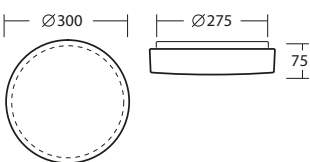

DELIA 1 IP44

Kód code код	typ type тип	Zdroj source лампа	příkon input [W]	objímka socket патрон	T [h]
--------------	--------------	--------------------	------------------	-----------------------	-------

POLYKARBONÁTOVÉ STÍNÍTKO / POLYCARBONATE SHADE

A					
56075	IN-12KN62/PC22		60	E27	
EVG					
56076	E-16KN62/PC22		26	G24q3	
56077	E-101KN62/PC22		22	2GX13	
56078	E-25KN62/PC22		2x18	2xG24q2	
S					
56079	IN-12KN62/PC22 HF		60	E27	
56080	E-16KN62/PC22 HF		26	G24q3	
N					
56081	NZ-13/PC22		13	G24q1	1,0
NE					
56082	NK-E-26/PC22		26	G24q3	1,0









LED IP44

Kód code код	kód code код	typ type тип	[lm]		příkon input [W]	T [h]	záruka Guarantee [years]
			3000K	4000K			
50250	50750	LED-1L13A07KN62/PC22 .000	1480	1480	16		3
50251	50751	LED-1L14A07KN62/PC22 .000	1970	1970	21		3
50252	50752	LED-4L02A10KN62/PC22 .000	2460	2630	30		5*
DIM							
50253	50753	LED-4L02A10KN62/PC22 1-10V .000	2460	2630	30		5
50254	50754	LED-4L02A10KN62/PC22 DALI .000	2460	2630	30		5
S							
50255	50755	LED-1L13A07KN62/PC22 HF .000	1480	1480	16		3
50256	50756	LED-4L02A10KN62/PC22 HF .000	2460	2630	30		5*
NE							
50257	50757	LED-1L13A07KN62/PC22/NK1W .000	1480	1480	16	3,0	3
50258	50758	LED-4L02A10KN62/PC22/NK1W .000	2460	2630	30	3,0	5*
NES							
50259	50759	LED-1L13A07KN62/PC22/NK1W HF .000	1480	1480	16	3,0	3
50260	50760	LED-4L02A10KN62/PC22/NK1W HF .000	2460	2630	30	3,0	5

DELIA 1 IP44

Kód code код	typ type тип	Zdroj source лампа	přikon input [W]	objímka socket патрон	T [h]
--------------------	--------------------	--------------------------	------------------------	-----------------------------	----------

PMMA STÍNÍTKO / PMMA SHADE

A					
56083	IN-12KN62/PM22		40	E27	
EVG					
56084	E-16KN62/PM22		26	G24q3	
56085	E-101KN62/PM22		22	2GX13	
56086	E-25KN62/PM22		2x18	2xG24q2	
S					
56087	IN-12KN62/PM22 HF		40	E27	
56088	E-16KN62/PM22 HF		26	G24q3	
N					
56089	NZ-13/PM22		13	G24q1	1,0
NE					
56090	NK-E-26/PM22		26	G24q3	1,0

LED IP44

Kód code код	kód code код	typ type тип	[lm] 3000K	[lm] 4000K	přikon input [W]	T [h]	záruka Guarantee [years]
50261	50761	LED-1L13A07KN62/PM22.000	1480	1480	16		3
50262	50762	LED-1L14A07KN62/PM22.000	1970	1970	21		3
50263	50763	LED-4L02A10KN62/PM22.000	2460	2630	30		5*
DIM							
50264	50764	LED-4L02A10KN62/PM22 1-10V.000	2460	2630	30		5
50265	50765	LED-4L02A10KN62/PM22 DALI.000	2460	2630	30		5
S							
50266	50766	LED-1L13A07KN62/PM22 HF.000	1480	1480	16		3
50267	50767	LED-4L02A10KN62/PM22 HF.000	2460	2630	30		5*
NE							
50268	50768	LED-1L13A07KN62/PM22/NK1W.000	1480	1480	16	3,0	3
50269	50769	LED-4L02A10KN62/PM22/NK1W.000	2460	2630	30	3,0	5*
NES							
50270	50770	LED-1L13A07KN62/PM22/NK1W HF.000	1480	1480	16	3,0	3
50271	50771	LED-4L02A10KN62/PM22/NK1W HF.000	2460	2630	30	3,0	5

* viz str. „See, см. страница, Siehe, voir : 204

NOVINKA/NEW



Ø 300 mm

Náhradní stínítko/spare shade/запасное стекло

Kód/code/код	Typ/Type/тип	D [mm]
20519	PM22	300

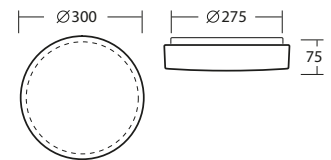

DELIA 2

NOVINKA/NEW



Ø 400 mm

Náhradní stínítko/spare shade/запасное стекло

Kód/code/код	Typ/Type/тип	D [mm]
20522	PC23	400

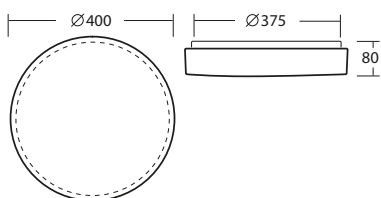

DELIA 2 IP44

Kód code код	typ type тип	Zdroj source лампа	příkon input [W]	objímka socket патрон	T [h]
--------------------	--------------------	--------------------------	------------------------	-----------------------------	----------

POLYKARBONÁTOVÉ STÍNÍTKO / POLYCARBONATE SHADE

A					
56110	IN-22KN83/PC23		2x60	2xE27	
EVG					
56111	E-25KN83/PC23		2x18	2xG24q2	
56112	E-26KN83/PC23		2x26	2xG24q3	
56113	E-102KN83/PC23		40	2GX13	
DIM					
56114	ES-26KN83/PC23 1-10V		2x26	2xG24q3	
56115	ES-26KN83/PC23 DALI		2x26	2xG24q3	
S					
56116	IN-22KN83/PC23 HF		2x40	2xE27	
56117	E-16KN83/PC23 HF		26	G24q3	
NE					
56118	NK-E-26/PC23		26	G24q3	1,0
56119	NKC-226/13/PC23		2x26	2xG24q3	1,0











LED IP44

Kód code код	kód code код	typ type тип	[lm] 3000K	[lm] 4000K	příkon input [W]	T [h]	záruka Guarantee [years]
50272	50772	LED-4L11A07KN83/PC23 .000	2950	2950	30		3
50273	50773	LED-6L02A10KN83/PC23 .000	3700	3940	43		5*
DIM							
50274	50774	LED-6L02A10KN83/PC23 1-10V .000	3700	3940	43		5
50275	50775	LED-6L02A10KN83/PC23 DALI .000	3700	3940	43		5
S							
50276	50776	LED-4L11A07KN83/PC23 HF .000	2950	2950	30		3
50277	50777	LED-6L02A10KN83/PC23 HF .000	3700	3940	43		5*
NE							
50278	50778	LED-4L11A07KN83/PC23/NK1W .000	2950	2950	30	3,0	3
50279	50779	LED-6L02A10KN83/PC23/NK1W .000	3700	3940	43	3,0	5*

DELIA 2 IP44

Kód code код	typ type тип	Zdroj source лампа	přikon input [W]	objímka socket патрон	T [h]
--------------------	--------------------	--------------------------	------------------------	-----------------------------	----------

PMMA STÍNÍTKO / PMMA SHADE

A					
56120	IN-22KN83/PM23		2x40	2xE27	
EVG					
56121	E-25KN83/PM23		2x18	2xG24q2	
56122	E-26KN83/PM23		2x26	2xG24q3	
56123	E-102KN83/PM23		40	2GX13	
DIM					
56124	ES-26KN83/PM23 1-10V		2x26	2xG24q3	
56125	ES-26KN83/PM23 DALI		2x26	2xG24q3	
S					
56126	IN-22KN83/PM23 HF		2x40	2xE27	
56127	E-16KN83/PM23 HF		26	G24q3	
NE					
56128	NK-E-26/PM23		26	G24q3	1,0
56129	NKC-226/13/PM23		2x26	2xG24q3	1,0

LED IP44

Kód code код	kód code код	typ type тип	[lm] 3000K	[lm] 4000K	přikon input [W]	T [h]	záruka Guarantee [years]
50280	50780	LED-4L11A07KN83/PM23 .000	2950	2950	30		3
50281	50781	LED-6L02A10KN83/PM23 .000	3700	3940	43		5*
DIM							
50282	50782	LED-6L02A10KN83/PM23 1-10V .000	3700	3940	43		5
50283	50783	LED-6L02A10KN83/PM23 DALI .000	3700	3940	43		5
S							
50284	50784	LED-4L11A07KN83/PM23 HF .000	2950	2950	30		3
50285	50785	LED-6L02A10KN83/PM23 HF .000	3700	3940	43		5*
NE							
50286	50786	LED-4L11A07KN83/PM23/NK1W .000	2950	2950	30	3,0	3
50287	50787	LED-6L02A10KN83/PM23/NK1W .000	3700	3940	43	3,0	5*

NOVINKA/NEW



Ø 400 mm

Náhradní stínítko/spare shade/запасное стекло

Kód/code/код	Typ/Type/тип	D [mm]
20521	PM23	400

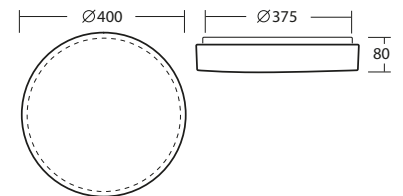

DELIA 3

NOVINKA/NEW



Ø 500 mm

Náhradní stínítko/spare shade/запасное стекло

Kód/code/код	Typ/Type/тип	D [mm]
20524	PC24	500

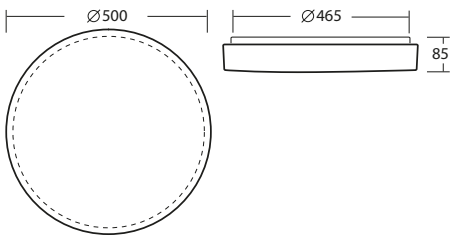

DELIA 3 IP44

Kód code код	typ type тип	Zdroj source лампа	příkon input [W]	objímka socket патрон	T [h]
--------------	--------------	--------------------	------------------	-----------------------	-------

POLYKARBONÁTOVÉ STÍNÍTKO / POLYCARBONATE SHADE

A					
56130	IN-32KN94/PC24		3x60	3xE27	

EVG					
56131	E-26KN94/PC24 32W		2x32	2xGX24q3	
56132	E-27KN94/PC24		2x36	2x2G10	
56133	E-46KN94/PC24		4x26	4xG24q3	
56134	E-204KN94/PC24		22+40	2x2GX13	

DIM					
56135	ES-46KN94/PC24 1-10V		4x26	4xG24q3	
56136	ES-46KN94/PC24 DALI		4x26	4xG24q3	

S					
56137	IN-32KN94/PC24 HF		3x40	3xE27	
56138	E-17KN94/PC24 HF		36	2G10	

NE					
56139	NK-E-36/PC24		36	2G10	1,0
56141	NKC-226/13/PC24		2x26	2xG24q3	1,0
56142	NKC-232/16/PC24		2x32	2xGX24q3	1,0

LED IP44

Kód code код	kód code код	typ type тип	[lm]	[lm]	příkon input [W]	T [h]	záruka Guarantee [years]
			3000K	4000K			
50288	50788	LED-4L12A07KN94/PC24 .000	3940	3940	41		3
50289	50789	LED-8L02A10KN94/PC24 .000	4930	5250	58		5*

DIM							
50290	50790	LED-8L02A10KN94/PC24 1-10V .000	4930	5250	58		5
50291	50791	LED-8L02A10KN94/PC24 DALI .000	4930	5250	58		5











S							
50292	50792	LED-4L12A07KN94/PC24 HF .000	3940	3940	41		3
50293	50793	LED-8L02A10KN94/PC24 HF .000	4930	5250	58		5*

NE							
50294	50794	LED-4L12A07KN94/PC24/NK1W .000	3940	3940	41	3,0	3
50295	50795	LED-8L02A10KN94/PC24/NK1W .000	4930	5250	58	3,0	5*

DELIA 3 IP44

Kód code код	typ type тип	Zdroj source лампа	příkon input [W]	objímka socket патрон	T [h]
--------------------	--------------------	--------------------------	------------------------	-----------------------------	----------

PMMA STÍNÍTKO / PMMA SHADE

A					
56143	IN-32KN94/PM24		3x40	3xE27	
EVG					
56144	E-26KN94/PM24 32W		2x32	2xGX24q3	
56145	E-27KN94/PM24		2x36	2x2G10	
56146	E-204KN94/PM24		22+40	2x2GX13	
DIM					
56147	ES-27KN94/PM24 1-10V		2x36	2x2G10	
56148	ES-27KN94/PM24 DALI		2x36	2x2G10	
S					
56149	IN-32KN94/PM24 HF		3x40	3xE27	
56150	E-17KN94/PM24 HF		36	2G10	
NE					
56151	NK-E-36/PM24		36	2G10	1,0
56153	NKC-226/13/PM24		2x26	2xG24q3	1,0
56154	NKC-232/16/PM24		2x32	2xGX24q3	1,0

LED IP44

Kód code код	kód code код	typ type тип	[lm] 3000K	[lm] 4000K	příkon input [W]	T [h]	záruka Guarantee [years]
50296	50796	LED-4L12A07KN94/PM24.000	3940	3940	41		3
50297	50797	LED-8L02A10KN94/PM24.000	4930	5250	58		5*
DIM							
50298	50798	LED-8L02A10KN94/PM24 1-10V.000	4930	5250	58		5
50299	50799	LED-8L02A10KN94/PM24 DALI.000	4930	5250	58		5
S							
50300	50800	LED-4L12A07KN94/PM24 HF.000	3940	3940	41		3
50301	50801	LED-8L02A10KN94/PM24 HF.000	4930	5250	58		5*
NE							
50302	50802	LED-4L12A07KN94/PM24/NK1W.000	3940	3940	41	3,0	3
50303	50803	LED-8L02A10KN94/PM24/NK1W.000	4930	5250	58	3,0	5*

NOVINKA/NEW



Ø 500 mm

Náhradní stínítko/spare shade/запасное стекло

Kód/code/код	Typ/Type/тип	D [mm]
20523	PM24	500

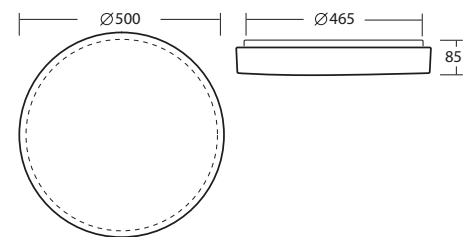

TILIA 1

NOVINKA/NEW



300x300 mm

Náhradní stínítko/spare shade/запасное стекло

Kód/code/код	Typ/Type/тип	a x b/размер [mm]
20526	PC32	300x300

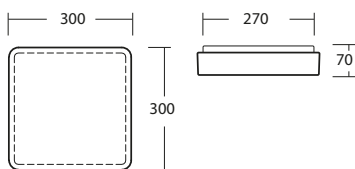

TILIA 1 IP44

Kód code код	typ type тип	Zdroj source лампа	příkon input [W]	objímka socket патрон	T [h]
--------------	--------------	--------------------	------------------	-----------------------	-------

POLYKARBONÁTOVÉ STÍNÍTKO / POLYCARBONATE SHADE

A					
56155	IN-22NU2/PC32		2x40	2xE27	
EVG					
56156	E-101NU2/PC32		22	2GX13	
56157	E-25NU2/PC32		2x18	2xG24q2	
56158	E-26NU2/PC32		2x26	2xG24q3	
S					
56159	IN-22NU2/PC32 HF		2x40	2xE27	
56160	E-25NU2/PC32 HF		2x18	2xG24q2	
N					
56161	NZ-13/PC32		13	G24q1	1,0
NE					
56162	NKC-218/13/PC32		2x18	2xG24q2	1,0









LED IP44

Kód code код	kód code код	typ type тип	[lm] 3000K	[lm] 4000K	příkon input [W]	T [h]	záruka Guarantee [years]
50310	50810	LED-1L14A07NU2/PC32 .000	1970	1970	21		3
50311	50811	LED-4L02A10NU2/PC32 .000	2460	2630	30		5*
DIM							
50312	50812	LED-4L02A10NU2/PC32 1-10V .000	2460	2630	30		5
50313	50813	LED-4L02A10NU2/PC32 DALI .000	2460	2630	30		5
S							
50314	50814	LED-1L14A07NU2/PC32 HF .000	1970	1970	21		3
50315	50815	LED-4L02A10NU2/PC32 HF .000	2460	2630	30		5*
NE							
50316	50816	LED-1L14A07NU2/PC32/NK1W .000	1970	1970	21	3,0	3
50317	50817	LED-4L02A10NU2/PC32/NK1W .000	2460	2630	30	3,0	5*

TILIA 1 IP44

Kód code код	typ type тип	Zdroj source лампа	přikon input [W]	objímka socket патрон	T [h]
--------------------	--------------------	--------------------------	------------------------	-----------------------------	----------

PMMA STÍNÍTKO / PMMA SHADE

A					
56163	IN-22NU2/PM32		2x40	E27	
EVG					
56164	E-101NU2/PM32		22	2GX13	
56165	E-25NU2/PM32		2x18	2xG24q2	
56166	E-26NU2/PM32		2x26	2xG24q3	
S					
56167	IN-22NU2/PM32 HF		2x40	2xE27	
56168	E-25NU2/PM32 HF		2x18	2xG24q2	
N					
56169	NZ-13/PM32		13	G24q1	1,0
NE					
56170	NKC-218/13/PM32		2x18	2xG24q2	1,0

LED IP44

Kód code код	kód code код	typ type тип	[lm] 3000K	[lm] 4000K	přikon input [W]	T [h]	záruka Guarantee [years]
50320	50820	LED-1L14A07NU2/PM32.000	1970	1970	21		3
50321	50821	LED-4L02A10NU2/PM32.000	2460	2630	30		5*
DIM							
50322	50822	LED-4L02A10NU2/PM32 1-10V.000	2460	2630	30		5
50323	50823	LED-4L02A10NU2/PM32 DALI.000	2460	2630	30		5
S							
50324	50824	LED-1L14A07NU2/PM32 HF.000	1970	1970	21		3
50325	50825	LED-4L02A10NU2/PM32 HF.000	2460	2630	30		5*
NE							
50326	50826	LED-1L14A07NU2/PM32/NK1W.000	1970	1970	21	3,0	3
50327	50827	LED-4L02A10NU2/PM32/NK1W.000	2460	2630	30	3,0	5*

NOVINKA/NEW



300x300 mm

Náhradní stínítko/spare shade/запасное стекло

Kód/code/код	Typ/Type/тип	a x b/размер [mm]
20525	PM32	300x300

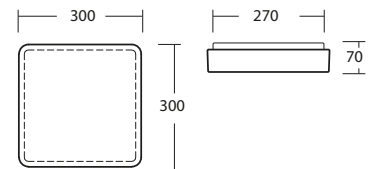

TILIA 2

NOVINKA/NEW



400x400 mm

Náhradní stínítko/spare shade/запасное стекло

Kód/code/код	Typ/Type/тип	a x b/размер [mm]
20528	PC33	400x400

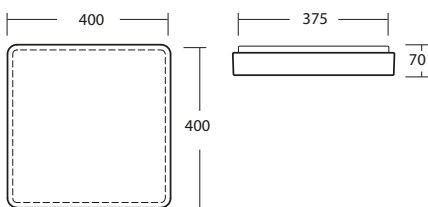

TILIA 2 IP44

Kód code код	typ type тип	Zdroj source лампа	příkon input [W]	objímka socket патрон	T [h]
--------------	--------------	--------------------	------------------	-----------------------	-------

POLYKARBONÁTOVÉ STÍNÍTKO / POLYCARBONATE SHADE

A					
56171	IN-32NU3/PC33		3x40	3xE27	
EVG					
56172	E-26NU3/PC33 32W		2x32	2xGX24q3	
56173	E-27NU3/PC33		2x36	2x2G10	
56174	E-204NU3/PC33		22+40	2x2GX13	
DIM					
56175	ES-26NU3/PC33 32W 1-10V		2x32	2xGX24q3	
56176	ES-26NU3/PC33 32W DALI		2x32	2xGX24q3	
S					
56177	IN-32NU3/PC33 HF		3x40	3xE27	
56178	E-26NU3/PC33 32W HF		2x32	2xGX24q3	
NE					
56180	NKC-232/16/PC33		2x32	2xGX24q3	1,0









LED IP44

Kód code код	kód code код	typ type тип	[lm]		příkon input [W]	T [h]	záruka Guarantee [years]
			3000K	4000K			
50330	50830	LED-4L11A07NU3/PC33.000	2950	2950	30		3
50331	50831	LED-4L12A07NU3/PC33.000	3940	3940	41		3
50332	50832	LED-8L02A10NU3/PC33.000	4930	5250	58		5*
DIM							
50333	50833	LED-8L02A10NU3/PC33 1-10V.000	4930	5250	58		5
50334	50834	LED-8L02A10NU3/PC33 DALI.000	4930	5250	58		5
S							
50335	50835	LED-4L11A07NU3/PC33 HF.000	2950	2950	30		3
50336	50836	LED-8L02A10NU3/PC33 HF.000	4930	5250	58		5*
NE							
50337	50837	LED-4L11A07NU3/PC33/NK1W.000	2950	2950	30	3,0	3
50338	50838	LED-8L02A10NU3/PC33/NK1W.000	4930	5250	58	3,0	5*

TILIA 2 IP44

Kód code код	typ type тип	Zdroj source лампа	přikon input [W]	objímka socket патрон	T [h]
--------------------	--------------------	--------------------------	------------------------	-----------------------------	----------

PMMA STÍNÍTKO / PMMA SHADE

A					
56181	IN-32NU3/PM33		3x40	3xE27	
EVG					
56182	E-26NU3/PM33 32W		2x32	2xGX24q3	
56183	E-27NU3/PM33		2x36	2xG10	
56184	E-204NU3/PM33		22+40	2xGX13	
DIM					
56185	ES-26NU3/PM33 32W 1-10V		2x32	2xGX24q3	
56186	ES-26NU3/PM33 32W DALI		2x32	2xGX24q3	
S					
56187	IN-32NU3/PM33 HF		3x40	3xE27	
56188	E-26NU3/PM33 32W HF		2x32	2xGX24q3	
NE					
56190	NKC-232/16/PM33		2x32	2xGX24q3	1,0

LED IP44

Kód code код	kód code код	typ type тип	[lm] 3000K	[lm] 4000K	přikon input [W]	T [h]	záruka Guarantee [years]
50340	50840	LED-4L11A07NU3/PM33.000	2950	2950	30		3
50341	80841	LED-4L12A07NU3/PM33.000	3940	3940	41		3
50342	50842	LED-8L02A10NU3/PM33.000	4930	5250	58		5*
DIM							
50343	50843	LED-8L02A10NU3/PM33 1-10V.000	4930	5250	58		5
50344	50844	LED-8L02A10NU3/PM33 DALI.000	4930	5250	58		5
S							
50345	50845	LED-4L11A07NU3/PM33 HF.000	2950	2950	30		3
50346	50846	LED-8L02A10NU3/PM33 HF.000	4930	5250	58		5*
NE							
50347	50847	LED-4L11A07NU3/PM33/NK1W.000	2950	2950	30	3,0	3
50348	50848	LED-8L02A10NU3/PM33/NK1W.000	4930	5250	58	3,0	5*

NOVINKA/NEW



400x400 mm

Náhradní stínítko/spare shade/запасное стекло

Kód/code/код	Typ/Type/тип	a x b/размер [mm]
20527	PM33	400x400

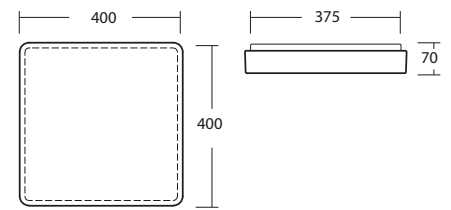

NOVINKA/NEW



Ø 490 mm

Náhradní stínítko/spare shade/запасное стекло

Kód/code/код	Typ/Type/тип	D [mm]
20517	PM48	490

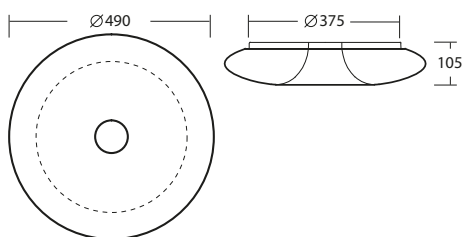

VICIA IP20

Kód code код	typ type тип	Zdroj source лампа	příkon input [W]	objímka socket патрон	T [h]
--------------	--------------	--------------------	------------------	-----------------------	-------

EVG

56070	E-102KNX83/PM48		40	2GX13	
56071	E-204KNX83/PM48		22+40	2x2GX13	
56072+	E-204KNX83/PM48 2/1		22+40	2x2GX13	

DIM

56073	ES-204KNX83/PM48 1-10V		22+40	2x2GX13	
56074	ES-204KNX83/PM48 DALI		22+40	2x2GX13	

+ - 2/1 – dvouokruhové ovládání světelných zdrojů/ two electric circuits /двухконтурное управление лампами/Lichtquellensteuerung durch 2 Schaltkreise/Commande a 2 circuits électriques

LED IP20

Kód code код	kód code код	typ type тип	[lm] 3000K	[lm] 4000K	příkon input [W]	T [h]	záruka Guarantee [years]
50305	50805	LED-6L02A10KNX83/PM48.000	3700	3940	43		5

DIM

50306	50806	LED-6L02A10KNX83/PM48 DALI.000	3700	3940	43		5
-------	-------	--------------------------------	------	------	----	--	---

S

50307	50807	LED-6L02A10KNX83/PM48 HF.000	3700	3940	43		5
-------	-------	------------------------------	------	------	----	--	---

NE

50308	50808	LED-6L02A10KNX83/PM48/NK1W.000	3700	3940	43	3,0	5
-------	-------	--------------------------------	------	------	----	-----	---



TITAN 13

**POPIS SVÍTIDEL**

Svítidlo tvoří montura z kovu a stínítka z PMMA
 Držení stínítka - ozdobnou maticí
 Montáž - na stěnu nebo na strop

DESCRIPTION OF THE LIGHTING FITTINGS

The light fittings consist of the metal fixture, and the PMMA shade
 Shade attachment - with decorative matrix
 Assembly - to the ceiling or on the wall

ОПИСАНИЕ СВЕТИЛЬНИКОВ

Светильник состоит из металлического основания и светорассеивателя из PMMA
 Крепление рассеивателя - декоративная гайка
 Установка - настенный, потолочный

BESCHREIBUNG DER LEUCHTEN

Die Leuchten bestehen aus einer Stahlblecharmatur und einer PMMA- Abdeckung
 Halterung der Abdeckscheibe - Ziermutter
 Montage - als Wand- oder Deckenleuchten

DESCRIPTION DES LUMINAIRES







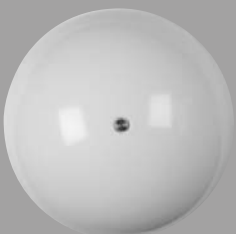

Les luminaires se composent d'une monture métallique et d'un abat-jour de PMMA
 Fixation de l'abat-jour - par matrice décorative
 Montage - sur un plafond ou sur un mur

Dekorativní límeček / Decorative ring / Декоративное кольцо / Dekorativer Ring/col décoratif

typ/type/ тип	barva/colour/цвет/ Couleur/Farbe
S4	- bílý lak, white paint, белый лак, Weißlack, laqué blanc
S12	- mosaz, brass, латунь, Messing, laiton
S14	- nerez, stainless steel polished, хром, Edelstahl poliert, inox poli
S15	- nerez broušená, steel ground, матовый хром, Edelstahl geschliffen, inox éroulu



TITAN 13 IP41

kód/S4 code/S4 код/S4	kód/S12 code/S12 код/S12	kód/S14 code/S14 код/S14	kód/S15 code/S15 код/S15	typ type тип	Zdroj source лампа	příkon input [W]	objímka socket патрон	T [h]
A								
44645	44657	44669	44681	IN-32T10/PM19/S..		3x60	3xE27	
EVG								
44646	44658	44670	44682	E-28T10/PM19/S..		2x42	2xGX24q4	
44647	44659	44671	44683	E-46T10/PM19/S..		4x26	4xGX24q3	
44648	44660	44672	44684	E-46T10/PM19/S..32W		4x32	4xGX24q3	
DIM								
44649	44661	44673	44685	ES-46T10/PM19/S..1-10V		4x26	4xGX24q3	
44651	44663	44675	44687	ES-46T10/PM19/S..DALI		4x26	4xGX24q3	
NE								
44655	44667	44679	44691	NKC-232/16/PM19/S..		2x32	2xGX24q3	1,0
44656	44668	44680	44692	NKC-242/16/PM19/S..		2x42	2xGX24q3	1,0



Náhradní stínítko/spare shade/запасное стекло

Kód/code/код	Typ/Type/тип	D [mm]
20512	PM19	500

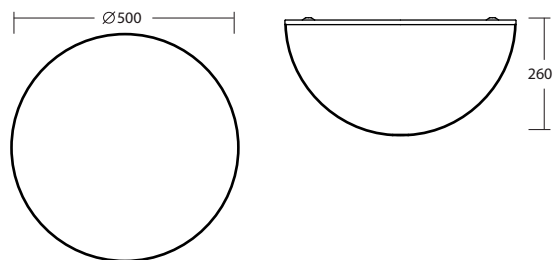

**POPIS SVÍTIDEL**

Svítidlo tvoří montura a stínítko z polykarbonátu
 Držení stínítka - soustavou západek, bezšroubkové
 Montáž - na stěnu nebo na strop

DESCRIPTION OF THE LIGHTING FITTINGS

The light fittings consist of the fixture and the polycarbonate shade
 Shade attachment - by the system of click-in-stop, without screws
 Assembly - to the ceiling or on the wall

ОПИСАНИЕ СВЕТИЛЬНИКОВ

Светильник состоит из основания и светорассеивателя из поликарбоната
 Крепление рассеивателя - система защелок, без использования винтов
 Установка - настенный, потолочный

BESCHREIBUNG DER LEUCHTEN









Die Leuchten bestehen aus einer Polykarbonatarmatur und einer Polykarbonatabdeckung
 Halterung der Abdeckscheibe - Rastmechanismus, schraubenlos
 Montage - als Wand- oder Deckenleuchten

DESCRIPTION DES LUMINAIRES

Les luminaires d'intérieur se composent d'une monture et d'un abat-jour en polycarbonate
 Fixation de l'abat-jour - système de loquat, sans vis
 Montage - sur un plafond ou sur un mur



VEGA IP41

Kód code код	typ type тип	Zdroj source лампа	přikon input [W]	objímka socket патрон	T [h]
A 					
56100	IN-66		2x40	2xE14	
VVG					
56101	IN-67/18		18	G24d2	
56102	IN-67/26		26	G24d3	
EVG					
56103	E-67/18		18	G24q2	
56104	E-67/22T5c		22	2GX13	
N					
56105	NZ-13/IN-66		13	G24q1	1,0
NE					
56106	NK-E-18/IN-66		18	G24q2	1,0



Náhradní stínítko/spare shade/запасное стекло

Kód/code/код	Typ/Type/тип	a x b/размер [mm]
20510	66	240x240

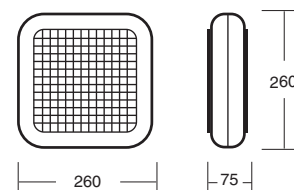

II.

ZÁVĚSNÁ SVÍTIDLA S OPÁLOVÝMI PLASTOVÝMI STÍNÍTKY
 PENDANT LIGHTING FITTINGS WITH OPAL PLASTIC SHADES
 ПОДВЕСНЫЕ СВЕТИЛЬНИКИ С ОПАЛОВЫМИ ПЛАСТИКОВЫМИ СВЕТОРАСSEИВАТЕЛЯМИ
 PENDELLEUCHTEN MIT OPALEN KUNSTSTOFFABDECKUNGEN
 LUMINAIRE SUSPENDU AVEC UN ABAT-JOUR EN PLASTIQUE OPALE

ISIS 3 176-181

ISIS L3, ISIS S3

ISIS 4 181-183

ISIS L4, ISIS S4

TITAN T 2,3 184-186

DELIA T 2,3 187-188

VICIA T 189

TITAN L 4,5 190-191

VELA L 192-193



ISIS



ISIS L



ISIS S



TITAN T 2,3



DELIA T 2,3



VICIA T



TITAN L 4,5

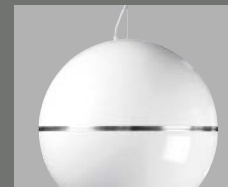

VELA L

CZ POPIS SVÍTIDEL:

Svítlidla tvoří tyčový, lankový nebo kabelový závěs a plastové stínítko	
Stínítko	- opalový polykarbonát, polymethylmetakrylát nebo polyetylen
Závěs	- tyčový – ocelová nebo nerezová trubka o průměru 10mm - lankový – ocelové lanko a transparentní přívodní šňůra - kabelový – transparentní nebo bílý kabelový závěs
Držení stínítka	- ocelový držák pro otvor 150mm (ISIS) - sklapovací systémy (TITAN T) - ozdobná matice – VELA L
Montáž	- na strop
Použití	- bytová výstavba, společenské prostory, školy, hotely

EN DESCRIPTION OF THE LIGHTING FITTINGS:

The light fittings consist of the of the steel bar, wire or cable pendant and polyethylen shade	
Shades	- opal polycarbonate - opal polymethylmetacrylate (PMMA) - opal polyethylen (PE)
Pendant	- bar – steel or stainless steel bar Ø 10mm - wire – steel wire pendant and transparent supply cable - cable – transparent or white cable
Shade attachment	- steel holder for Ø 150 mm (ISIS) - clap holders (TITAN T) - decorative matrix – VELA L
Assembly	- to the ceiling
Applications	- housing constructions, hotels, schools, cultural premises

RUS ОПИСАНИЕ СВЕТИЛЬНИКОВ:

Светильники состоят из жесткого, гибкого или кабельного подвеса и пластикового светорассеивателя	
Светорассеиватель	- опаловый поликарбонат, полиметилакрилат или полиэтилен
Подвес	- жесткий – металлическая трубка диаметром 10 мм - гибкий – металлический трос и прозрачный электрический шнур - кабельный – прозрачный или белый кабель
Крепление рассеивателя	- металлическое крепление для отверстия 150мм (ISIS) - откидные фиксаторы – защелки (TITAN T) - декоративная гайка – VELA L
Установка	- потолочный
Назначение	- жилые помещения, общественные помещения, школы, гостиницы

DE BESCHREIBUNG DER LEUCHTEN:

Die Leuchten bestehen aus einer Stangen-,Seil- oder Kabelaufhängung und einer Kunststoffabdeckung	
Abdeckung	- opal Polykarbonat, Polymethylmethakrylat oder Polyethylen
Aufhängung	- Stahl- oder Edelstahlrohr mit Ø 10 mm - Seilaufhängung – Edelstahl, transparentes Anschlusskabel - Kabelaufhängung – transparentes oder weißes Kabel
Halterung der Abdeckscheibe	- Stahlhalterungen für Öffnung mit 150 mm (ISIS) - klappbare doppelverstellbare Halterungen (TITAN T) - Ziermutter – VELA L
Montage	- als Deckenleuchten
Einsatz	- Wohnungsbau, Gemeinschaftsräume, Schulen, Hotels

F DESCRIPTION DES LUMINAIRES

Les luminaires d'intérieur se composent d'une suspension par tige ou par câble et d'un abat-jour en plastique	
Abat-jour	- polycarbonate opale, polymethylmetacrylate ou polyethylene
Suspension	- par tige – tube d'acier ou d'acier inox d'un Ø 10 mm - par fil – fil métallique et cordon d'alimentation transparent - par câble – câble de suspension blanc ou transparent
Fixation de l'abat-jour	- support d'acier pour une ouverture de 150mm (ISIS) - supports clips à deux positions (TITAN T) - matrice décorative – VELA L
Montage	- sur un plafond
Utilisation	- immeubles, locaux publics, écoles, hôtels

ISIS 3,4
 ISIS L3,4
 ISIS S3,4



POPIS SVÍTIDEL

Svítidlo tvoří tyčový (ISIS), lankový (ISIS L) nebo kabelový (ISIS S) závěs a stínítka z polyethylenu
 Držení stínítka – ocelový držák pro otvor 150 mm

Upozornění: svítidlo lze vybavit i LED zdroji – www.osmont.cz

DESCRIPTION OF THE LIGHTING FITTINGS

The light fittings consist of the of the steel bar (ISIS), wire (ISIS L) or cable (ISIS S) pendant and polyethylen shade
 Shade attachment – steel holder for Ø 150 mm

Notice: Lighting fittings can be equipped by LED moduls : www.osmont.cz

ОПИСАНИЕ СВЕТИЛЬНИКОВ

Светильник состоит из жесткого (ISIS), гибкого (ISIS L) или кабельного (ISIS S) подвеса и светорассеивателя из полиэтилена

Крепление рассеивателя – металлическое крепление для отверстия 150 мм (ISIS)

Внимание: светильник также может быть оборудован светодиодами – www.osmont.cz

BESCHREIBUNG DER LEUCHTEN

Die Leuchten bestehen aus einer Stangenaufhängung (ISIS), Seilaufhängung (ISIS L) oder Kabelaufhängung (ISIS S) und einer Polyethylenabdeckung.

Halterung der Abdeckscheibe – Stahlhalterungen für Öffnung mit Ø 150 mm

Hinweis: Die Leuchten können mit den LED-Modulen Osmont bestückt werden : www.osmont.cz

DESCRIPTION DES LUMINAIRES

Les luminaires se composent d'une suspension par tige (ISIS), par fil ISIS L), ou par câble (ISIS S), et d'une abat-jour en polyethylene

câble et d'un abat – jour en polyethylene

Fixation de l'abat-jour – support d'acier pour une ouverture de 150mm

Remarque: Les luminaires peuvent être équipés de modules LED Osmont: www.osmont.cz

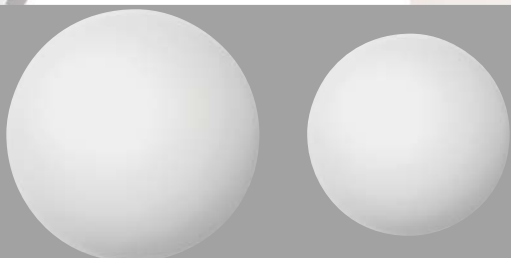

Provedení závěsů , Colour of rod pendants , Покрытие подвесов
 Ausführung der Stangenabhängung, Installation des suspensions par tige:

typ/type/ тип	barva/colour/цвет/ Couleur/Farbe
B	– bílý lak , white paint, белый лак, Weißlack, laqué blanc
MS	– mosaz, brass, латунь, Messing, laiton
NL	– nerez leštěná, stainless steel polished, хром, Edelstahl poliert, inox poli
NB	– nerez broušená , steel ground, матовый хром, Edestahl geschliffen, inox émaulu

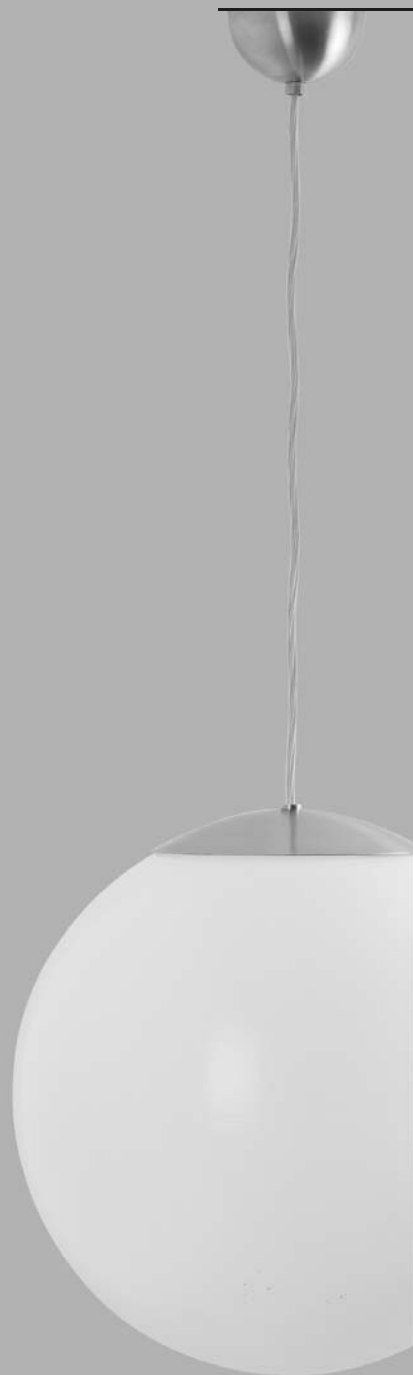
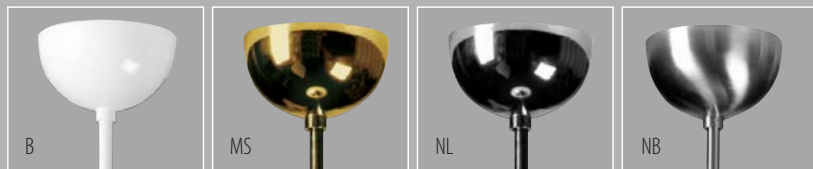

tyčový závěs / steel bar / жесткий
 подвес, Stangenabhängung/
 Suspension par tige

typ/type	délka/length [mm]
a1	200
a2	400
a3	600
a4	800
a5	1000

lankový závěs / wire pendant/
 гибкий подвес/ Seilabhängung/
 Suspension par fil

typ/type	délka/length [mm]
L100	1000
L200	2000

kabelový závěs/Cable pendant/
 кабельный подвес/ Kabelabhängung /
 Suspension par câble

typ/type	délka/length [mm]
L100	1000

NOVINKA/NEW

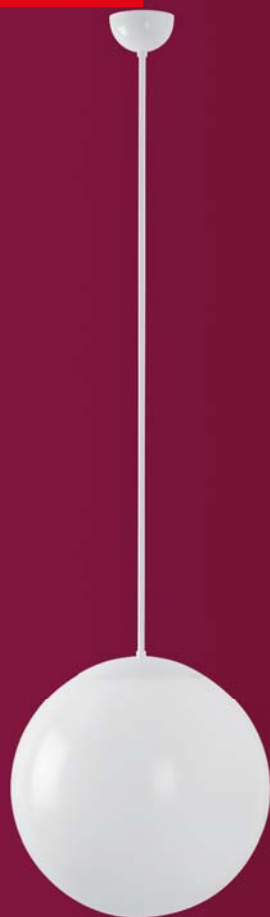

Ø 400 mm

Náhradní stínítka/spare shade/запасное стекло

Kód/code/код	Typ/Type/тип	D [mm]
20530	PE3	400

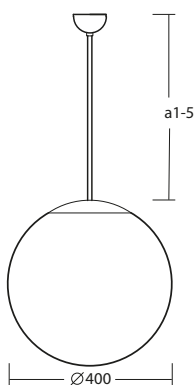

tyčový závěs / bar pendant / жесткий
подвес / Stangenaufhängung / Suspension
par tige

typ/type	délka/length [mm]
a1	200
a2	400
a3	600
a4	800
a5	1000

ISIS 3 IP40

kód/a1 code/a1 код/1a	kód/a2 code/a2 код/a2	kód/a3 code/a3 код/a3	kód/a4 code/a4 код/a4	kód/a5 code/a5 код/a5	typ type тип	příkon input [W]	objímka socket патрон	T [h]
-----------------------------	-----------------------------	-----------------------------	-----------------------------	-----------------------------	--------------------	------------------------	-----------------------------	----------

ISIS 3-B bílá/white

A								
45900	45901	45902	45903	45904	Z11/PE3/a. B	75	E27	
EVG								
45905	45906	45907	45908	45909	E-26Z11/PE3/a. B	2x26	2xG24q3	
45910	45911	45912	45913	45914	E-28Z11/PE3/a. B	2x42	2xGX24q4	
DIM								
45915	45916	45917	45918	45919	ES-26Z11/PE3/a. B 1-10V	2x26	2xG24q3	
45920	45921	45922	45923	45924	ES-26Z11/PE3/a. B DALI	2x26	2xG24q3	
NE								
45925	45926	45927	45928	45929	NKC-226Z11/13/PE3/a. B	2x26	2xG24q3	1,0

ISIS 3-MS mosaz/brass

A								
45930	45931	45932	45933	45934	Z11/PE3/a. MS	150	E27	
EVG								
45935	45936	45937	45938	45939	E-26Z11/PE3/a. MS	2x26	2xG24q3	
45940	45941	45942	45943	45944	E-28Z11/PE3/a. MS	2x42	2xGX24q4	
DIM								
45945	45946	45947	45948	45949	ES-26Z11/PE3/a. MS 1-10V	2x26	2xG24q3	
45950	45951	45952	45953	45954	ES-26Z11/PE3/a. MS DALI	2x26	2xG24q3	
NE								
45955	45956	45957	45958	45959	NKC-226Z11/13/PE3/a. MS	2x26	2xG24q3	1,0

ISIS 3-NL nerez leštěná / stainless steel polished

A								
45960	45961	45962	45963	45964	Z11/PE3/a. NL	150	E27	
EVG								
45965	45966	45967	45968	45969	E-26Z11/PE3/a. NL	2x26	2xG24q3	
45970	45971	45972	45973	45974	E-28Z11/PE3/a. NL	2x42	2xGX24q4	
DIM								
45975	45976	45977	45978	45979	ES-26Z11/PE3/a. NL 1-10V	2x26	2xG24q3	
45980	45981	45982	45983	45984	ES-26Z11/PE3/a. NL DALI	2x26	2xG24q3	
NE								
45985	45986	45987	45988	45989	NKC-226Z11/13/PE3/a. NL	2x26	2xG24q3	1,0

ISIS 3-NB nerez broušená / stainless steel ground

A								
45990	45991	45992	45993	45994	Z11/PE3/a. NB	150	E27	
EVG								
45995	45996	45997	45998	45999	E-26Z11/PE3/a. NB	2x26	2xG24q3	
46000	46001	46002	46003	46004	E-28Z11/PE3/a. NB	2x42	2xGX24q4	
DIM								
46005	46006	46007	46008	46009	ES-26Z11/PE3/a. NB 1-10V	2x26	2xG24q3	
46010	46011	46012	46013	46014	ES-26Z11/PE3/a. NB DALI	2x26	2xG24q3	
NE								
46015	46016	46017	46018	46019	NKC-226Z11/13/PE3/a. NB	2x26	2xG24q3	1,0

ISIS L3 IP40

kód/L100 code/L100 код/L100	kód/L200 code/L200 код/L200	typ type тип	příkon input [W]	objímka socket патрон	T [h]
-----------------------------------	-----------------------------------	--------------------	------------------------	-----------------------------	----------

ISIS L3-B bílá/white

A					
46020	46021	ZL11/PE3/L.. B	75	E27	
EVG					
46022	46023	E-26ZL11/PE3/L.. B	2x26	2xG24q3	
46024	46025	E-28ZL11/PE3/L.. B	2x42	2xGX24q4	
DIM					
46026	46027	ES-26ZL11/PE3L.. B 1-10V	2x26	2xG24q3	
46028	46029	ES-26ZL11/PE3/L.. B DALI	2x26	2xG24q3	
NE					
46030	46031	NKC-226ZL/13/PE3/L.. B	2x26	2xG24q3	1,0

ISIS L3-MS mosaz/brass

A					
46032	46033	ZL11/PE3/L.. MS	150	E27	
EVG					
46034	46035	E-26ZL11/PE3/L.. MS	2x26	2xG24q3	
46036	46037	E-28ZL11/PE3/L.. MS	2x42	2xGX24q4	
DIM					
46038	46039	ES-26ZL11/PE3/L.. MS 1-10V	2x26	2xG24q3	
46040	46041	ES-26ZL11/PE3/L.. MS DALI	2x26	2xG24q3	
NE					
46042	46043	NKC-226ZL/13/PE3/L.. MS	2x26	2xG24q3	1,0

ISIS L3-NL nerez leštěná / stainless steel polished

A					
46044	46045	ZL11/PE3/L.. NL	150	E27	
EVG					
46046	46047	E-26ZL11/PE3/L.. NL	2x26	2xG24q3	
46048	46049	E-28ZL11/PE3/L.. NL	2x42	2xGX24q4	
DIM					
46050	46051	ES-26ZL11/PE3/L.. NL 1-10V	2x26	2xG24q3	
46052	46053	ES-26ZL11/PE3/L.. NL DALI	2x26	2xG24q3	
NE					
46054	46055	NKC-226ZL/13/PE3/L.. NL	2x26	2xG24q3	1,0

ISIS L3-NB nerez broušená / stainless steel ground

A					
46056	46057	ZL11/PE3/L.. NB	150	E27	
EVG					
46058	46059	E-26ZL11/PE3/L.. NB	2x26	2xG24q3	
46060	46061	E-28ZL11/PE3/L.. NB	2x42	2xGX24q4	
DIM					
46062	46063	ES-26ZL11/PE3/L.. NB 1-10V	2x26	2xG24q3	
46064	46065	ES-26ZL11/PE3/L.. NB DALI	2x26	2xG24q3	
NE					
46066	46067	NKC-226ZL/13/PE3/L.. NB	2x26	2xG24q3	1,0

NOVINKA/NEW



Ø 400 mm

Náhradní stínítko/spare shade/запасное стекло

Kód/code/код	Typ/Type/тип	D [mm]
20530	PE3	400

lankový závěs / wire pendant / гибкий подвес / Seilaufhängung/Suspension par fil

typ/type	délka/length [mm]
L100	1000
L200	2000

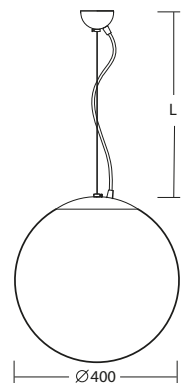

NOVINKA/NEW



Ø 400 mm

Náhradní stínítko/spare shade/запасное стекло

Kód/code/код	Typ/Type/тип	D [mm]
20530	PE3	400

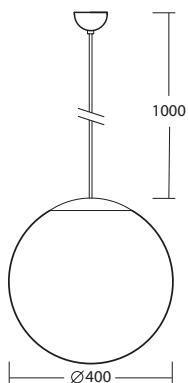
kabelový závěs /cable pendant/
кабельный подвес/Kabelaufhängung/
Suspension par câble

typ/type	délka/length [mm]
L100	1000

ISIS S3 IP40

kód/B code/B код/В	kód/MS code/MS код/MS	kód/NL code/NL код/NL	kód/NB code/NB код/NB	typ type тип	příkon input [W]	objímka socket патрон	T [h]
A							
46070	46076	46082	46088	ZS11/PE3/L100 ..	75	E27	
EVG							
46071	46077	46083	46089	E-26ZS11/PE3/L100 ..	2x26	2xG24q3	
46072	46078	46084	46090	E-28ZS11/PE3/L100 ..	2x42	2xGX24q4	
DIM							
46073	46079	46085	46091	ES-26ZS11/PE3/L100 .. 1-10V	2x26	2xG24q3	
46074	46080	46086	46092	ES-26ZS11/PE3/L100 .. DALI	2x26	2xG24q3	
NE							
46075	46081	46087	46093	NKC-226ZS/13/PE3/L100 ..	2x26	2xG24q3	1,0

ISIS 4 IP40

kód/a1 code/a1 код/1a	kód/a2 code/a2 код/а2	kód/a3 code/a3 код/а3	kód/a4 code/a4 код/а4	kód/a5 code/a5 код/а5	typ type тип	přikon input [W]	objímka socket патрон	T [h]
-----------------------------	-----------------------------	-----------------------------	-----------------------------	-----------------------------	--------------------	------------------------	-----------------------------	----------

ISIS 4-B bílá /white

A								
46700	46701	46702	46703	46704	Z11/PE4/a. B	100	E27	

EVG

46705	46706	46707	46708	46709	E-28Z11/PE4/a. B	2x42	2xGX24q4	
46710	46711	46712	46713	46714	E-46Z11/PE4/a. B	4x26	4xGX24q3	

DIM

46715	46716	46717	46718	46719	ES-46Z11/PE4/a. B 1-10V	4x26	4xGX24q3	
46720	46721	46722	46723	46724	ES-46Z11/PE4/a. B DALI	4x26	4xGX24q3	

NE

46725	46726	46727	46728	46729	NKC-232Z11/16/PE4/a. B	2x32	2xGX24q3	1,0
-------	-------	-------	-------	-------	------------------------	------	----------	-----

ISIS 4-MS mosaz /brass

A								
46730	46731	46732	46733	46734	Z11/PE4/a. MS	100	E27	

EVG

46735	46736	46737	46738	46739	E-28Z11/PE4/a. MS	2x42	2xGX24q4	
46740	46741	46742	46743	46744	E-46Z11/PE4/a. MS	4x26	4xGX24q3	

DIM

46745	46746	46747	46748	46749	ES-46Z11/PE4/a. MS 1-10V	4x26	4xGX24q3	
46750	46751	46752	46753	46754	ES-46Z11/PE4/a. MS DALI	4x26	4xGX24q3	

NE

46755	46756	46757	46758	46759	NKC-232Z11/16/PE4/a. MS	2x32	2xGX24q3	1,0
-------	-------	-------	-------	-------	-------------------------	------	----------	-----

ISIS 4-NL nerez leštěná / stainless steel polished

A								
46760	46761	46762	46763	46764	Z11/PE4/a. NL	100	E27	

EVG

46765	46766	46767	46768	46769	E-28Z11/PE4/a. NL	2x42	2xGX24q4	
46770	46771	46772	46773	46774	E-46Z11/PE4/a. NL	4x26	4xGX24q3	

DIM

46775	46776	46777	46778	46779	ES-46Z11/PE4/a. NL 1-10V	4x26	4xGX24q3	
46780	46781	46782	46783	46784	ES-46Z11/PE4/a. NL DALI	4x26	4xGX24q3	

NE

46785	46786	46787	46788	46789	NKC-232Z11/16/PE4/a. NL	2x32	2xGX24q3	1,0
-------	-------	-------	-------	-------	-------------------------	------	----------	-----

ISIS 4-NB nerez broušená / stainless steel ground

A								
46810	46811	46812	46813	46814	Z11/PE4/a. NB	100	E27	

EVG

46815	46816	46817	46818	46819	E-28Z11/PE4/a. NB	2x42	2xGX24q4	
46820	46821	46822	46823	46824	E-46Z11/PE4/a. NB	4x26	4xGX24q3	

DIM

46825	46826	46827	46828	46829	ES-46Z11/PE4/a. NB 1-10V	4x26	4xGX24q3	
46830	46831	46832	46833	46834	ES-46Z11/PE4/a. NB DALI	4x26	4xGX24q3	

NE

46835	46836	46837	46838	46839	NKC-232Z11/16/PE4/a. NB	2x32	2xGX24q3	1,0
-------	-------	-------	-------	-------	-------------------------	------	----------	-----

NOVINKA/NEW



Náhradní stínítko/spare shade/запасное стекло

Kód/code/код	Typ/Type/тип	D [mm]
20531	PE4	500

tyčový závěs / bar pendant / жесткий подвес / Stangenaufhängung / Suspension par tige

typ/type	délka/length [mm]
a1	200
a2	400
a3	600
a4	800
a5	1000

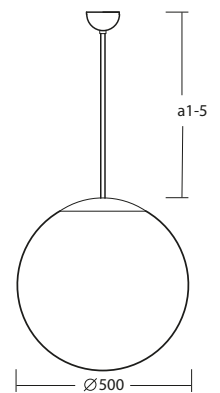

NOVINKA/NEW



Ø 500 mm

Náhradní stínítko/spare shade/запасное стекло

Kód/code/код	Typ/Type/тип	D [mm]
20531	PE4	500

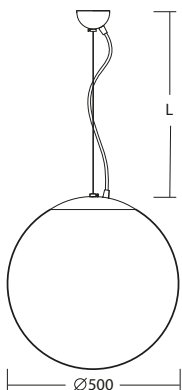

lankový závěs / wire pendant / гибкий подвес / Seilabhängung/Suspension par fil

typ/type	délka/length [mm]
L100	1000
L200	2000

ISIS L4 IP40

kód/L100 code/L100 код/L100	kód/L200 code/L200 код/L200	typ type тип	přikon input [W]	objímka socket патрон	T [h]
-----------------------------------	-----------------------------------	--------------------	------------------------	-----------------------------	----------

ISIS L4-B bílá/white

A					
46840	46841	ZL11/PE4/L.. B	100	E27	
EVG					
46842	46843	E-28ZL11/PE4/L.. B	2x42	2xGX24q4	
46844	46845	E-46ZL11/PE4/L.. B	4x26	4xG24q3	
DIM					
46846	46847	ES-46ZL11/PE4/L.. B 1-10V	4x26	4xG24q3	
46848	46849	ES-46ZL11/PE4/L.. B DALI	4x26	4xG24q3	
NE					
46850	46851	NKC-232ZL/16/PE4/L.. B	2x32	2xGX24q3	1,0

ISIS L4-MS mosaz/brass

A					
46852	46853	ZL11/PE4/L.. MS	100	E27	
EVG					
46854	46855	E-28ZL11/PE4/L.. MS	2x42	2xGX24q4	
46856	46857	E-46ZL11/PE4/L.. MS	4x26	4xG24q3	
DIM					
46858	46859	ES-46ZL11/PE4/L.. MS 1-10V	4x26	4xG24q3	
46860	46861	ES-46ZL11/PE4/L.. MS DALI	4x26	4xG24q3	
NE					
46862	46863	NKC-232ZL/16/PE4/L.. MS	2x32	2xGX24q3	1,0

ISIS L4-NL nerez leštěná / stainless steel polished

A					
46864	46865	ZL11/PE4/L.. NL	100	E27	
EVG					
46866	46867	E-28ZL11/PE4/L.. NL	2x42	2xGX24q4	
46868	46869	E-46ZL11/PE4/L.. NL	4x26	4xG24q3	
DIM					
46870	46871	ES-46ZL11/PE4/L.. NL 1-10V	4x26	4xG24q3	
46872	46873	ES-46ZL11/PE4/L.. NL DALI	4x26	4xG24q3	
NE					
46874	46875	NKC-232ZL/16/PE4/L.. NL	2x32	2xGX24q3	1,0

ISIS L4-NB nerez broušená / stainless steel ground

A					
46876	46877	ZL11/PE4/L.. NB	100	E27	
EVG					
46878	46879	E-28ZL11/PE4/L.. NB	2x42	2xGX24q4	
46880	46881	E-46ZL11/PE4/L.. NB	4x26	4xG24q3	
DIM					
46882	46883	ES-46ZL11/PE4/L.. NB 1-10V	4x26	4xG24q3	
46884	46885	ES-46ZL11/PE4/L.. NB DALI	4x26	4xG24q3	
NE					
46886	46887	NKC-232ZL/16/PE4/L.. NB	2x32	2xGX24q3	1,0

ISIS S4 IP40

kód/B code/B код/В	kód/MS code/MS код/MS	kód/NL code/NL код/NL	kód/NB code/NB код/NB	typ type тип	příkon input [W]	objímka socket патрон	T [h]
A							
44180	44186	44192	44198	ZS11/PE4/L100 ..	100	E27	
EVG							
44181	44187	44193	44199	E-28ZS11/PE4/L100 ..	2x42	2xG24q4	
44182	44188	44194	44200	E-46ZS11/PE4/L100 ..	4x26	4xG24q3	
DIM							
44183	44189	44195	44201	ES-46ZS11/PE4/L100 .. 1-10V	4x26	4xG24q3	
44184	44190	44196	44202	ES-46ZS11/PE4/L100 .. DALI	4x26	4xG24q3	
NE							
44185	44191	44197	44203	NKC-232ZS/16/PE4/L100 ..	2x32	2xG24q3	1,0

NOVINKA/NEW



Ø 500 mm

Náhradní stínítko/spare shade/запасное стекло

Kód/code/код	Typ/Type/тип	D [mm]
20531	PE4	500

kabelový závěs / cable pendant/
кабельный подвес/Kabelaufhängung/
Suspension par câble

typ/type	délka/length [mm]
L100	1000

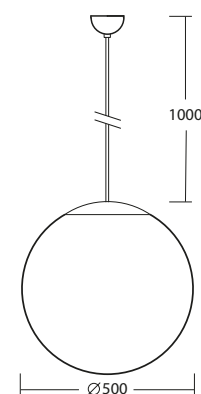

TITANT2,3 DELIA T2,3 VICIA T



POPIS SVÍTIDEL

Svítidla jsou tvořena kovovou monturou, plastovým stínítkem a třílankovým závěsem
Třílankový závěs je ze dvou částí:

1. jednoduché lanko s nastavitelnou délkou
2. tři lanka spojená v jednom úchytu

Stínítka	- opalový polykarbonát. ODOLNOST PROTI NÁRÁZŮM JE MIN 44Nm (IK10) - opalový polymethylmetakrylát (PMMA)
Držení stínítka	- sklápovacími držáky,
Montáž	- na strop

DESCRIPTION OF THE LIGHTING FITTINGS

Light fittings consist of the metal fixture, plastic shade and three-wire pendant.
Three-wire pendant consist of the two parts:

1. Simple wire with adjustable length
2. three wires connected in one lug

Shades	- opal polycarbonate, SHOCK RESISTANCE IS MIN 44 Nm (IK10) - opal polymethylmetacrylate (PMMA)
Shade attachment	- with folding two-step clamp holders
Assembly	- to the ceiling

ОПИСАНИЕ СВЕТИЛЬНИКОВ

Светильники состоят из металлического основания, пластикового светорассеивателя и подвеса из трех стальных тросов

Подвес состоит из двух частей:

1. обыкновенный трос с регулируемой длиной
2. три стальных троса соединенные в одном креплении

Светорассеиватель	- опаловый поликарбонат. УДАРОПРОЧНОСТЬ составляет 44 Nm (IK10) - опаловый полиметилакрилат (PMMA)
Крепление рассеивателя	- фиксаторы защелки
Установка	- потолочный

BESCHREIBUNG DER LEUCHTEN

Die Leuchten bestehen aus einer Stahlblecharmatur, einer Kunststoffabdeckung und einer Dreiseilaufhängung

Die Dreiseilaufhängung besteht aus zwei Teilen:

1. einfaches Seil mit verstellbarer Länge
2. Drei Seile verbunden in einer Halterung.

Abdeckung	- Opal Polykarbonat, STOBBESTÄNDIGKEIT BETRÄGT MIN 44Nm (IK10) - Opal Polymethylmetakrylat (PMMA)
Halterung der Abdeckscheibe	- klappbare Halterungen
Montage	- als Deckenleuchten

DESCRIPTION DES LUMINAIRES

Tous les luminaires d'intérieur se composent d'une monture métallique, un abat-jour en plastique et 3- câbles d'acier

La suspension en triangle est constituée de deux parties:

1. un simple fil avec la possibilité de régler la longueur
2. trois fils reliés par un connecteur

Abat-jour	- opal polycarbonate, RÉSISTANCE CONTRE LE SHOCK EST 44Nm (IK10) - opal polymethylmethacrylate (PMMA)
Fixation de l'abat-jour	- supports basculants à deux positions
Montage	- sur un plafond



TITAN T2 IP41

Kód code код	typ type тип	Zdroj source лампа	příkon input [W]	objímka socket патрон	T [h]
--------------------	--------------------	--------------------------	------------------------	-----------------------------	----------

POLYKARBONÁTOVÉ STÍNÍTKO / POLYCARBONATE SHADE

A					
52000	IN-22ZT11/PC08/L100		2x60	2xE27	
EVG					
52001	E-25ZT11/PC08/L100		2x18	2xG24q2	
52002	E-26ZT11/PC08/L100		2x26	2xG24q3	
52003	E-102ZT11/PC08/L100		40	2GX13	
DIM					
52004	ES-26ZT11/PC08/L100 1-10V		2x26	2xG24q3	
52005	ES-26ZT11/PC08/L100 DALI		2x26	2xG24q3	
NE					
52006	NKC-226ZT/13/PC08/L100		2x26	2xG24q3	1,0

LED IP41

Kód code код	kód code код	typ type тип	[lm] 3000K	[lm] 4000K	příkon input [W]	T [h]	záruka Guarantee [years]
50350	50850	LED-4L11A07ZT11/PC08/L100.000	2950	2950	30		3
50351	50851	LED-6L02A10ZT11/PC08/L100.000	3700	3940	43		5*
DIM							
50352	50852	LED-6L02A10ZT11/PC08/L100 1-10V.000	3700	3940	43		5
50353	50853	LED-6L02A10ZT11/PC08/L100 DALI.000	3700	3940	43		5
NE							
50354	50854	LED-4L11A07ZT11/PC08/NK1W/L100.000	2950	2950	30	3,0	3
50355	50855	LED-6L02A10ZT11/PC08/NK1W/L100.000	3700	3940	43	3,0	5*

TITAN T2 IP41

Kód code код	typ type тип	Zdroj source лампа	příkon input [W]	objímka socket патрон	T [h]
--------------------	--------------------	--------------------------	------------------------	-----------------------------	----------

PMMA STÍNÍTKO / PMMA SHADE

A					
52007	IN-22ZT11/PM08/L100		2x40	2xE27	
EVG					
52008	E-25ZT11/PM08/L100		2x18	2xG24q2	
52009	E-26ZT11/PM08/L100		2x26	2xG24q3	
52010	E-102ZT11/PM08/L100		40	2GX13	
DIM					
52011	ES-26ZT11/PM08/L100 1-10V		2x26	2xG24q3	
52012	ES-26ZT11/PM08/L100 DALI		2x26	2xG24q3	
NE					
52013	NKC-226ZT/13/PM08/L100		2x26	2xG24q3	1,0

LED IP41

Kód code код	kód code код	typ type тип	[lm] 3000K	[lm] 4000K	příkon input [W]	T [h]	záruka Guarantee [years]
50356	50856	LED-4L11A07ZT11/PM08/L100.000	2950	2950	30		3
50357	50857	LED-6L02A10ZT11/PM08/L100.000	3700	3940	43		5*
DIM							
50358	50858	LED-6L02A10ZT11/PM08/L100 1-10V.000	3700	3940	43		5
50359	50859	LED-6L02A10ZT11/PM08/L100 DALI.000	3700	3940	43		5
NE							
50360	50860	LED-4L11A07ZT11/PM08/L100/NK1W.000	2950	2950	30	3,0	3
50361	50861	LED-6L02A10ZT11/PM08/L100/NK1W.000	3700	3940	43	3,0	5*

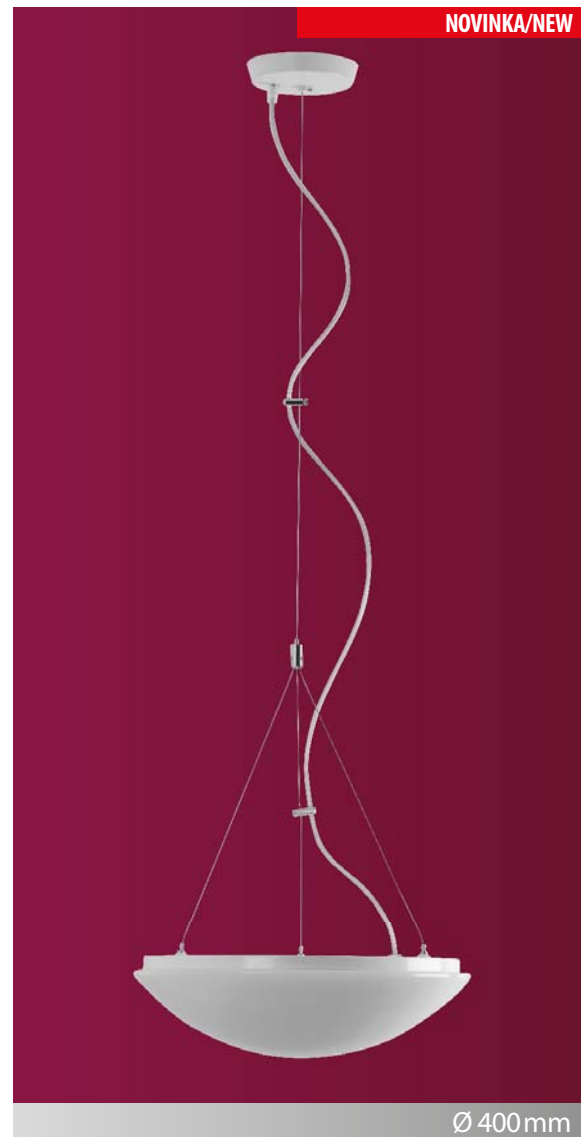

Náhradní stínítko/spare shade/запасное стекло

Kód/code/код	Typ/Type/тип	D [mm]
20505	PC08	400

Náhradní stínítko/spare shade/запасное стекло

Kód/code/код	Typ/Type/тип	D [mm]
20508	PM08	400

lankový závěs / wire pendant / гибкий подвес / Seilabhängung/Suspension par fil

typ/type	délka/length [mm]
L100	1000

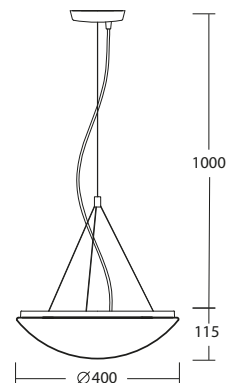

TITAN T3

NOVINKA/NEW

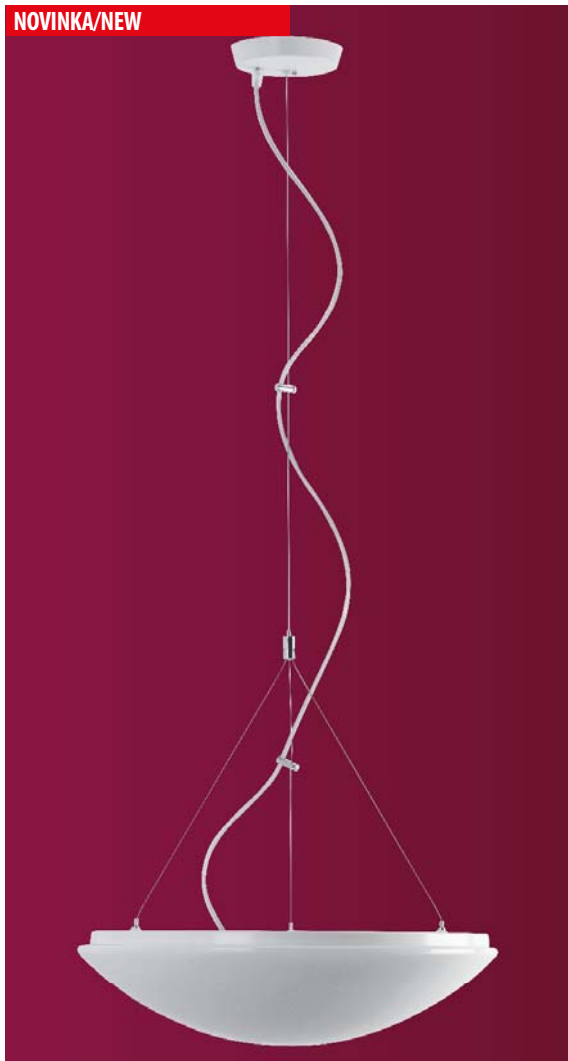

Ø 500 mm

Náhradní stínítko/spare shade/запасное стекло

Kód/code/код	Typ/Type/тип	D [mm]
20506	PC09	500

Náhradní stínítko/spare shade/запасное стекло

Kód/code/код	Typ/Type/тип	D [mm]
20509	PM09	500

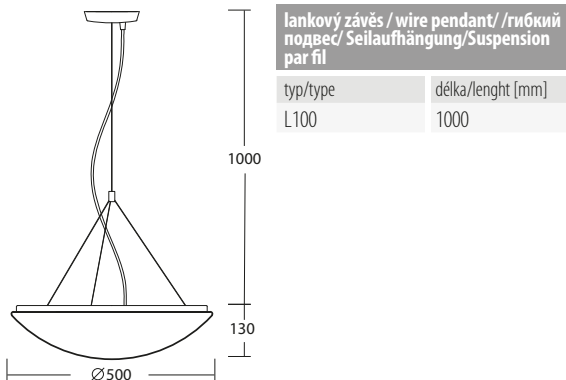

lankový závěs / wire pendant / гибкий подвес / Seilaufhängung / Suspension par fil

typ/type	délka/length [mm]
L100	1000

TITAN T3 IP41

Kód code код	typ type тип	Zdroj source лампа	příkon input [W]	objímka socket патрон	T [h]
--------------	--------------	--------------------	------------------	-----------------------	-------

POLYKARBONÁTOVÉ STÍNÍTKO / POLYCARBONATE SHADE

A					
52015	IN-32ZT11/PC09/L100		3x60	3xE27	
EVG					
52016	E-26ZT11/PC09/L100 32W		2x32	2xGX24q3	
52017	E-27ZT11/PC09/L100		2x36	2xG10	
52018	E-46ZT11/PC09/L100		4x26	4xG24q3	
52019	E-204ZT11/PC09/L100		22+40	2x2GX13	
DIM					
52020	ES-46ZT11/PC09/L100 1-10V		4x26	4xG24q3	
52021	ES-46ZT11/PC09/L100 DALI		4x26	4xG24q3	
NE					
52022	NKC-232ZT/16/PC09/L100		2x32	2xGX24q3	1,0

LED IP41

Kód code код	kód code код	typ type тип	[lm]	[lm]	příkon input [W]	T [h]	záruka Guarantee [years]
3000K	4000K		3000K	4000K			
50365	50865	LED-4L12A07ZT11/PC09/L100.000	3940	3940	41		3
50366	50866	LED-8L02A10ZT11/PC09/L100.000	4930	5250	58		5*
DIM							
50367	50867	LED-8L02A10ZT11/PC09/L100 1-10V.000	4930	5250	58		5
50368	50868	LED-8L02A10ZT11/PC09/L100 DALI.000	4930	5250	58		5
NE							
50369	50869	LED-4L12A07ZT11/PC09/NK1W/L100.000	3940	3940	41	3,0	3
50370	50870	LED-8L02A10ZT11/PC09/NK1W/L100.000	4930	5250	58	3,0	5*

TITAN T3 IP41

Kód code код	typ type тип	Zdroj source лампа	příkon input [W]	objímka socket патрон	T [h]
--------------	--------------	--------------------	------------------	-----------------------	-------

PMMA STÍNÍTKO / PMMA SHADE

A					
52023	IN-32ZT11/PM09/L100		3x40	3xE27	
EVG					
52024	E-26ZT11/PM09/L100 32W		2x32	2xGX24q3	
52025	E-27ZT11/PM09/L100		2x36	2xG10	
52026	E-46ZT11/PM09/L100		4x26	4xG24q3	
52027	E-204ZT11/PM09/L100		22+40	2x2GX13	
DIM					
52028	ES-46ZT11/PM09/L100 1-10V		4x26	4xG24q3	
52029	ES-46ZT11/PM09/L100 DALI		4x26	4xG24q3	
NE					
52030	NKC-232ZT/16/PM09/L100		2x32	2xGX24q3	1,0

LED IP41

Kód code код	kód code код	typ type тип	[lm]	[lm]	příkon input [W]	T [h]	záruka Guarantee [years]
3000K	4000K		3000K	4000K			
50371	50871	LED-4L12A07ZT11/PM09/L100.000	3940	3940	41		3
50372	50872	LED-8L02A10ZT11/PM09/L100.000	4930	5250	58		5*
DIM							
50373	50873	LED-8L02A10ZT11/PM09/L100 1-10V.000	4930	5250	58		5
50374	50874	LED-8L02A10ZT11/PM09/L100 DALI.000	4930	5250	58		5
NE							
50375	50875	LED-4L12A07ZT11/PM09/NK1W/L100.000	3940	3940	41	3,0	3
50376	50876	LED-8L02A10ZT11/PM09/NK1W/L100.000	4930	5250	58	3,0	5*

NOVINKA/NEW

DELIA T2 IP41

Kód code код	typ type тип	Zdroj source лампа	příkon input [W]	objímka socket патрон	T [h]
--------------------	--------------------	--------------------------	------------------------	-----------------------------	----------

POLYKARBONÁTOVÉ STÍNÍTKO / POLYCARBONATE SHADE

A					
52050	IN-22ZT11/PC23/L100		2x60	2xE27	
EVG					
52051	E-25ZT11/PC23/L100		2x18	2xG24q2	
52052	E-26ZT11/PC23/L100		2x26	2xG24q3	
52053	E-102ZT11/PC23/L100		40	2GX13	
DIM					
52054	ES-26ZT11/PC23/L100 1-10V		2x26	2xG24q3	
52055	ES-26ZT11/PC23/L100 DALI		2x26	2xG24q3	
NE					
52056	NKC-226ZT/13/PC23/L100		2x26	2xG24q3	1,0

LED IP41

Kód code код	kód code код	typ type тип	[lm] 3000K	[lm] 4000K	příkon input [W]	T [h]	záruka Guarantee [years]
50400	50900	LED-4L11A07ZT11/PC23/L100.000	2950	2950	30		3
50401	50901	LED-6L02A10ZT11/PC23/L100.000	3700	3940	43		5*
DIM							
50402	50902	LED-6L02A10ZT11/PC23/L100 1-10V.000	3700	3940	43		5
50403	50903	LED-6L02A10ZT11/PC23/L100 DALI.000	3700	3940	43		5
NE							
50404	50904	LED-4L11A07ZT11/PC23/L100/NK1W.000	2950	2950	30	3,0	3
50405	50905	LED-6L02A10ZT11/PC23/L100/NK1W.000	3700	3940	43	3,0	5*

DELIA T2 IP41

Kód code код	typ type тип	Zdroj source лампа	příkon input [W]	objímka socket патрон	T [h]
--------------------	--------------------	--------------------------	------------------------	-----------------------------	----------

PMMA STÍNÍTKO / PMMA SHADE

A					
52057	IN-22ZT11/PM23/L100		2x40	2xE27	
EVG					
52058	E-25ZT11/PM23/L100		2x18	2xG24q2	
52059	E-26ZT11/PM23/L100		2x26	2xG24q3	
52060	E-102ZT11/PM23/L100		40	2GX13	
DIM					
52061	ES-26ZT11/PM23/L100 1-10V		2x26	2xG24q3	
52062	ES-26ZT11/PM23/L100 DALI		2x26	2xG24q3	
NE					
52063	NKC-226ZT/13/PM23/L100		2x26	2xG24q3	1,0

LED IP41

Kód code код	kód code код	typ type тип	[lm] 3000K	[lm] 4000K	příkon input [W]	T [h]	záruka Guarantee [years]
50406	50906	LED-4L11A07ZT11/PM23/L100.000	2950	2950	30		3
50407	50907	LED-6L02A10ZT11/PM23/L100.000	3700	3940	43		5*
DIM							
50408	50908	LED-6L02A10ZT11/PM23/L100 1-10V.000	3700	3940	43		5
50409	50909	LED-6L02A10ZT11/PM23/L100 DALI.000	3700	3940	43		5
NE							
50410	50910	LED-4L11A07ZT11/PM23/L100/NK1W.000	2950	2950	30	3,0	3
50411	50911	LED-6L02A10ZT11/PM23/L100/NK1W.000	3700	3940	43	3,0	5*

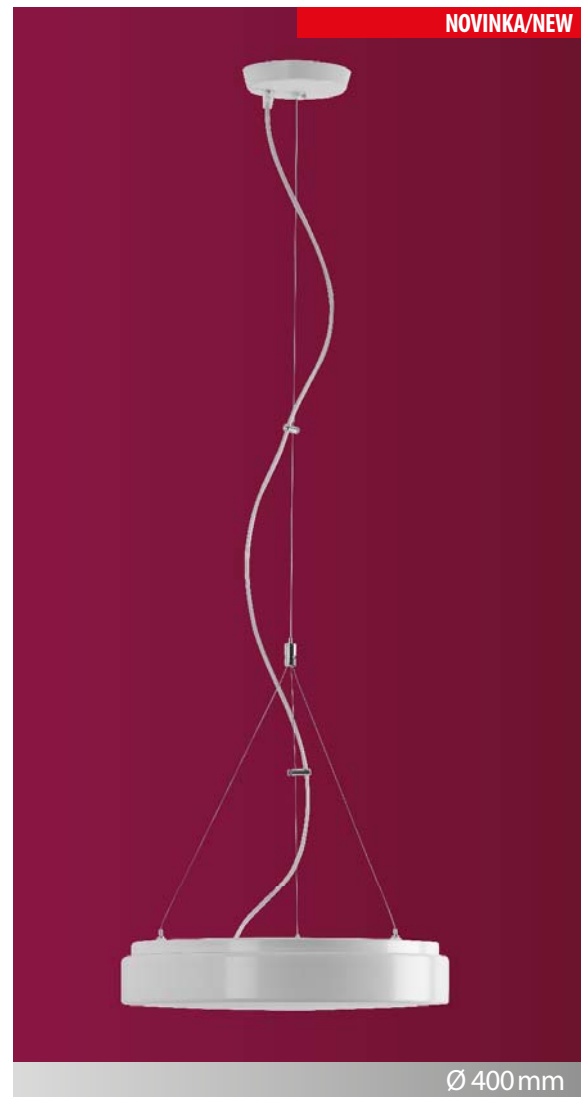

Ø 400 mm

Náhradní stínítko/spare shade/запасное стекло

Kód/code/код	Typ/Type/тип	D [mm]
20522	PC23	400

Náhradní stínítko/spare shade/запасное стекло

Kód/code/код	Typ/Type/тип	D [mm]
20521	PM23	400

lankový závěs / wire pendant / гибкий подвес / Seilaufhängung/Suspension par fil

typ/type	délka/length [mm]
L100	1000

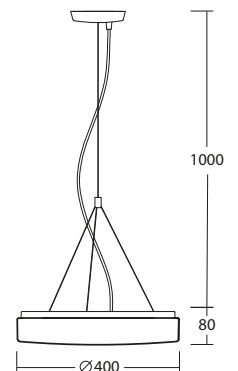

DELIA T3

NOVINKA/NEW



Ø 500 mm

Náhradní stínítko/spare shade/запасное стекло

Kód/code/код	Typ/Type/тип	D [mm]
20524	PC24	500

Náhradní stínítko/spare shade/запасное стекло

Kód/code/код	Typ/Type/тип	D [mm]
20523	PM24	500

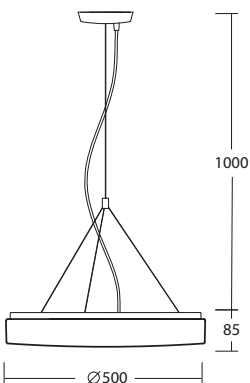

lankový závěs / wire pendant / гибкий подвес / Seilabhängung / Suspension par fil

typ/type	délka/length [mm]
L100	1000

DELIA T3 IP41

Kód code код	typ type тип	Zdroj source лампа	příkon input [W]	objímka socket патрон	T [h]
--------------	--------------	--------------------	------------------	-----------------------	-------

POLYKARBONÁTOVÉ STÍNÍTKO / POLYCARBONATE SHADE

A					
52065	IN-32ZT11/PC24/L100		3x60	3xE27	
EVG					
52066	E-26ZT11/PC24/L100 32W		2x32	2xGX24q3	
52067	E-27ZT11/PC24/L100		2x36	2xG10	
52068	E-46ZT11/PC24/L100		4x26	4xG24q3	
52069	E-204ZT11/PC24/L100		22+40	2xGX13	
DIM					
52070	ES-46ZT11/PC24/L100 1-10V		4x26	4xG24q3	
52071	ES-46ZT11/PC24/L100 DALI		4x26	4xG24q3	
NE					
52072	NKC-232ZT/16/PC24/L100		2x32	2xGX24q3	1,0

LED IP41

Kód code код	kód code код	typ type тип	[lm]	[lm]	příkon input [W]	T [h]	záruka Guarantee [years]
3000K	4000K		3000K	4000K			
50415	50915	LED-4L12A07ZT11/PC24/L100.000	3940	3940	41		3
50416	50916	LED-8L02A10ZT11/PC24/L100.000	4930	5250	58		5*
DIM							
50417	50917	LED-8L02A10ZT11/PC24/L100 1-10V.000	4930	5250	58		5
50418	50918	LED-8L02A10ZT11/PC24/L100 DALI.000	4930	5250	58		5
NE							
50419	50919	LED-4L12A07ZT11/PC24/NK1W/L130.000	3940	3940	41	3,0	3
50420	50920	LED-8L02A10ZT11/PC24/NK1W/L130.000	4930	5250	58	3,0	5*

DELIA T3 IP41

Kód code код	typ type тип	Zdroj source лампа	příkon input [W]	objímka socket патрон	T [h]
--------------	--------------	--------------------	------------------	-----------------------	-------

PMMA STÍNÍTKO / PMMA SHADE

A					
52073	IN-32ZT11/PM24/L100		3x40	3xE27	
EVG					
52074	E-26ZT11/PM24/L100 32W		2x32	2xGX24q3	
52075	E-27ZT11/PM24/L100		2x36	2xG10	
52076	E-46ZT11/PM24/L100		4x26	4xG24q3	
52077	E-204ZT11/PM24/L100		22+40	2xGX13	
DIM					
52078	ES-46ZT11/PM24/L100 1-10V		4x26	4xG24q3	
52079	ES-46ZT11/PM24/L100 DALI		4x26	4xG24q3	
NE					
52080	NKC-232ZT/16/PM24/L100		2x32	2xGX24q3	1,0

LED IP41

Kód code код	kód code код	typ type тип	[lm]	[lm]	příkon input [W]	T [h]	záruka Guarantee [years]
3000K	4000K		3000K	4000K			
50421	50921	LED-4L12A07ZT11/PM24/L100.000	3940	3940	41		3
50422	50922	LED-8L02A10ZT11/PM24/L100.000	4930	5250	58		5*
DIM							
50423	50923	LED-8L02A10ZT11/PM24/L100 1-10V.000	4930	5250	58		5
50424	50924	LED-8L02A10ZT11/PM24/L100 DALI.000	4930	5250	58		5
NE							
50425	50925	LED-4L12A07ZT11/PM24/NK1W/L100.000	3940	3940	41	3,0	3
50426	50926	LED-8L02A10ZT11/PM24/NK1W/L100.000	4930	5250	58	3,0	5*

VICIA T IP20

Kód code код	typ type тип	Zdroj source лампа	příkon input [W]	objímka socket патрон	T [h]
--------------------	--------------------	--------------------------	------------------------	-----------------------------	----------

PMMA STÍNÍTKO / PMMA SHADE

EVG

52090	E-102ZT11/PM48/L100	☉	40	2GX13	
52091	E-204ZT11/PM48/L100	☉	22+40	2x2GX13	
52092+	E-204ZT11/PM48/L100 2/1	☉	22+40	2x2GX13	

DIM

52093	ES-204ZT11/PM48/L100 1-10V	☉	22+40	2x2GX13	
52094	ES-204ZT11/PM48/L100 DALI	☉	22+40	2x2GX13	

+ - 2/1 – dvouokružové ovládání světelných zdrojů/ two electric circuits /двухконтурное управление лампами/Lichtquellensteuerung durch 2 Schaltkreise/Commande a 2 circuits électriques

LED IP20

Kód code код	kód code код	typ type тип	[lm] 3000K	[lm] 4000K	příkon input [W]	T [h]	záruka Guarantee [years]
50430	50930	LED-6L02A10ZT11/PM48/L100 .000	3700	3940	43		5
50431	50931	LED-6L02A10ZT11/PM48/L100 1-10V .000	3700	3940	43		5
50432	50932	LED-6L02A10ZT11/PM48/L100 DALI .000	3700	3940	43		5

DIM

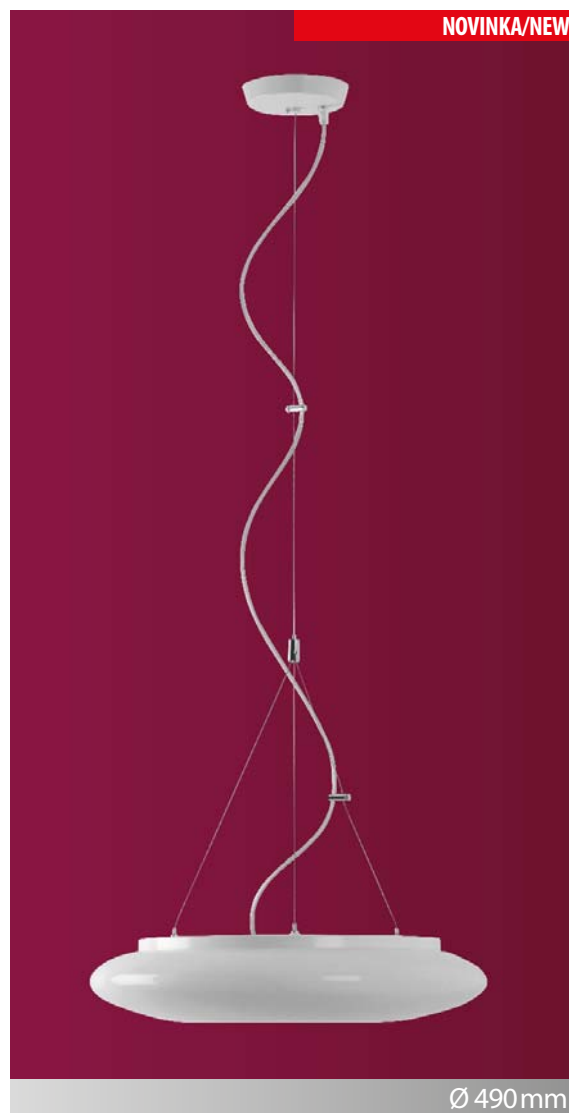

Náhradní stínítko/spare shade/запасное стекло

Kód/code/код	Typ/Type/тип	D [mm]
20517	PM48	490

lankový závěs / wire pendant / гибкий подвес / Seilaufhängung/Suspension par fil

typ/type	délka/length [mm]
L100	1000

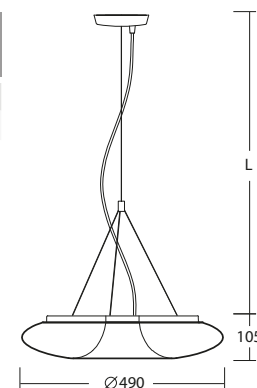

TITAN L4,5

**POPIS SVÍTIDEL**

Svítidla jsou tvořena kovovou monturou, plastovým stínítkem a třemi lankovými závěsy
 Stínítko - opálový polymethylmetakrylát (PMMA)
 Držení stínítka - sklapovacími držáky

DESCRIPTION OF THE LIGHTING FITTINGS

The lighting fittings consist of the metal fixture, plastic shade and of the three wire pendants
 Shade - opal polymethylmethacrylate (PMMA)
 Shade attachment - with folding two-step clamp holders

ОПИСАНИЕ СВЕТИЛЬНИКОВ

Светильники состоят из металлического основания, пластикового светорассеивателя и трех гибких подвесов
 Светорассеиватель - опаловый полиметилакрилат (PMMA)
 Крепление рассеивателя - фиксаторы-защелки

BESCHREIBUNG DER LEUCHTEN

Die Leuchten bestehen aus der einer Stahlblecharmatur, einer Kunststoffabdeckung und drei Seilauhängungen
 Abdeckung - opal Polymethylmethakrylat (PMMA)
 Halterung der Abdeckscheibe - klappbare Halterungen

DESCRIPTION DES LUMINAIRES

Les luminaires se composent d'une monture métallique, d'un abat-jour en plastique et d'une suspension par trois fils
 Abat-jour - polymethylmethacrylate opale (PMMA)
 Fixation de l'abat-jour - supports clips

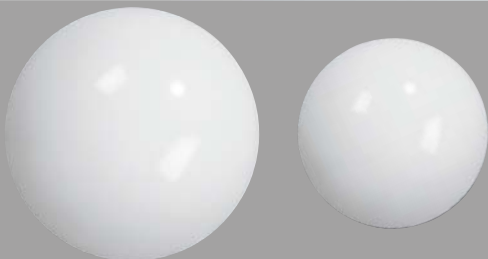



TITAN L4



TITAN L4 IP41

Kód code код	typ type тип	Zdroj source лампа	přikon input [W]	objímka socket патрон	T [h]
--------------------	--------------------	--------------------------	------------------------	-----------------------------	----------

PMMA STÍNÍTKO / PMMA SHADE

A					
52035	IN-42ZL11/PM10/L100		4x40	4xE27	

EVG					
52036	E-48ZL11/PM10/L100		4x42	4xGX24q4	
52037	E-47ZL11/PM10/L100		4x36	4x2G10	

DIM					
52038	ES-47ZL11/PM10/L100 1-10V		4x36	4x2G10	
52039	ES-47ZL11/PM10/L100 DALI		4x36	4x2G10	

LED IP41

Kód code код	kód code код	typ type тип	[lm]		přikon input [W]	T [h]	záruka Guarantee [years]
			3000K	4000K			
50380	50880	LED-4L13A07ZL11/PM10/L100.000	5900	5900	59		3
50381	50881	LED-12L02A10ZL11/PM10/L100.000	7390	7880	86		5*
DIM							
50382	50882	LED-12L02A10ZL11/PM10/L100 1-10V.000	7390	7880	86		5
50383	50883	LED-12L02A10ZL11/PM10/L100 DALI.000	7390	7880	86		5

Náhradní stínítko/spare shade/
запасное стекло

Kód/code/код	Typ/Type/тип	D [mm]
20515	PM10	650

lankový závěs / wire pendant / гибкий
подвес / Seilaufhängung/Suspension
par fil

typ/type	délka/length [mm]
L100	1000

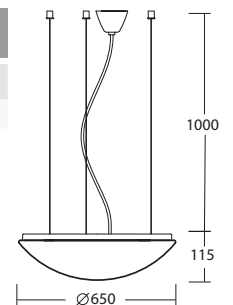



TITAN L5



TITAN L5 IP41

Kód code код	typ type тип	Zdroj source лампа	přikon input [W]	objímka socket патрон	T [h]
--------------------	--------------------	--------------------------	------------------------	-----------------------------	----------

PMMA STÍNÍTKO / PMMA SHADE

A					
52040	IN-62ZL11/PM11/L100		6x40	6xE27	

EVG					
52041	E-66ZL11/PM11/L100		6x24	G5	
52042	E-67ZL11/PM11/L100		6x36	6x2G10	

DIM					
52043	ES-67ZL11/PM11/L100 1-10V		6x36	6x2G10	
52044	ES-67ZL11/PM11/L100 DALI		6x36	6x2G10	

LED IP41

Kód code код	kód code код	typ type тип	[lm]		přikon input [W]	T [h]	záruka Guarantee [years]
			3000K	4000K			
50385	50885	LED-6L13A07ZL11/PM11/L100.000	8860	8860	88		3
50386	50886	LED-16L02A10ZL11/PM11/L100.000	9860	10510	129		5*
DIM							
50387	50887	LED-16L02A10ZL11/PM11/L100 1-10V.000	9860	10510	129		5
50388	50888	LED-16L02A10ZL11/PM11/L100 DALI.000	9860	10510	129		5

Náhradní stínítko/spare shade/
запасное стекло

Kód/code/код	Typ/Type/тип	D [mm]
20516	PM11	900

lankový závěs / wire pendant / гибкий
подвес / Seilaufhängung/Suspension
par fil

typ/type	délka/length [mm]
L100	1000

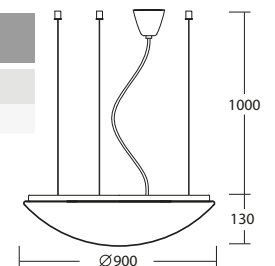

**POPIS SVÍTIDEL**

Svítidlo tvoří lankový závěs, ocelová montura a stínítko z PMMA

Závěs	- nerezové lanko s transparentním přívodním kabelem o délce 1m nebo 2m
Stínítko	- PMMA
Držení stínítkka	- ozdobná matice

DESCRIPTION OF THE LIGHTING FITTINGS

The lighting consist of wire pendant, steel fixture and PMMA shade

Pendant	- stainless steel wire pendant with transparent supply cable in length 1m or 2m
Shade	- PMMA
Shade attachment	- decorative matrix

ОПИСАНИЕ СВЕТИЛЬНИКОВ

Светильник состоит из гибкого подвеса, металлического основания и светорассеивателя из PMMA

Подвес – металлический трос с прозрачным электрическим шнуром длиной 1м или 2м	
Светорассеиватель	- PMMA
Крепление рассеивателя	- декоративная гайка

BESCHREIBUNG DER LEUCHTEN

Die Leuchten bestehen aus einer Seilaufhängung, einer Stahlarmatur und einer Abdeckung in PMMA

Aufhängung	- Edestahlseilaufhängung mit transparentem Anschlusskabel in einer Länge von 1m oder 2m
Abdeckung	- PMMA
Halterung der Abdeckscheibe	- Ziermutter

DESCRIPTION DES LUMINAIRES

Les luminaires se composent d' une suspension par trois fils, d' une monture en acier et d'un abat-jour en PMMA

Suspension	- fils d'acier inox avec cordon d'alimentation transparent d'une longueur de 1m ou 2 m
Abat-jour	- PMMA
Fixation de l'abat-jour	- matrice décorative

Provedení lankových závěsů / Wire pendant colours/ Покрытие гибкого подвеса**typ/type/тип barva/colour/цвет/ Couleur/Farbe**

B bílá, white, белый, Weiß, Blanc

NL nerez leštěná , stainless steel polished, хром, Edelstahl poliert, inox poli

NB nerez broušená / stainless steel ground / матовый хром / Edelstahl geschliffen / Inox émoulu

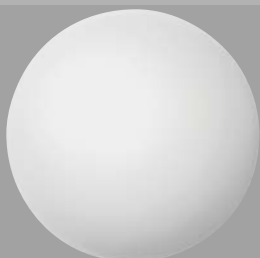
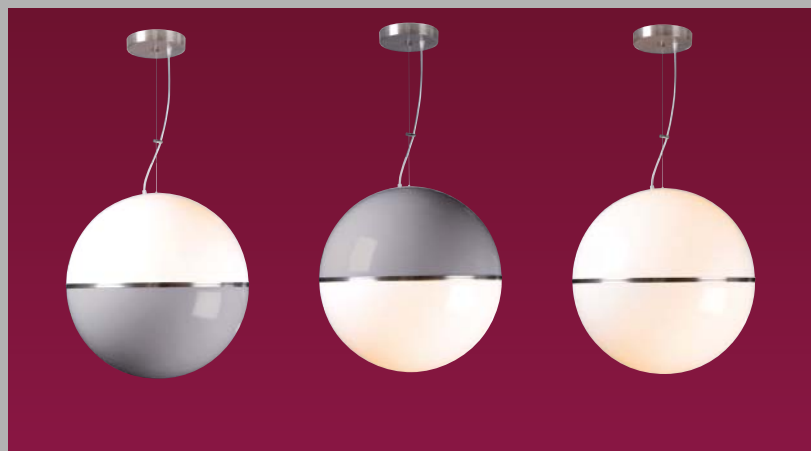
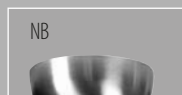
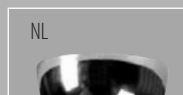

VELA L IP40

kód/L100 code/L100 код/L100	kód/L200 code/L200 код/L200	typ type тип	příkon input [W]	objímka socket патрон	T [h]
-----------------------------------	-----------------------------------	--------------------	------------------------	-----------------------------	----------

VELA L-B bílá/white

A					
45620	45621	IN-42ZL11/PM19/L.. B 2/2	4x40	4xE27	

EVG

45622	45623	E-46ZL11/PM19/L.. B 2/2	4x26	4xG24q3	
45624	45625	E-48ZL11/PM19/L.. B 2/2	4x42	4xGX24q4	

DIM

45626	45627	ES-48ZL11/PM19/L.. B 2/2 1-10V	4x42	4xGX24q4	
45630	45631	ES-48ZL11/PM19/L.. B 2/2 DALI	4x42	4xGX24q4	

VELA L-NL nerez leštěná / stainless steel polished

A					
45632	45633	IN-42ZL11/PM19/L.. NL 2/2	4x40	4xE27	

EVG

45634	45635	E-46ZL11/PM19/L.. NL 2/2	4x26	4xG24q3	
45636	45637	E-48ZL11/PM19/L.. NL 2/2	4x42	4xGX24q4	

DIM

45638	45639	ES-48ZL11/PM19/L.. NL 2/2 1-10V	4x42	4xGX24q4	
45642	45643	ES-48ZL11/PM19/L.. NL 2/2 DALI	4x42	4xGX24q4	

VELA L-NB nerez broušená / stainless steel ground

A					
45644	45645	IN-42ZL11/PM19/L.. NB 2/2	4x40	4xE27	

EVG

45646	45647	E-46ZL11/PM19/L.. NB 2/2	4x26	4xG24q3	
45648	45649	E-48ZL11/PM19/L.. NB 2/2	4x42	4xGX24q4	

DIM

45650	45651	ES-48ZL11/PM19/L.. NB 2/2 1-10V	4x42	4xGX24q4	
45654	45655	ES-48ZL11/PM19/L.. NB 2/2 DALI	4x42	4xGX24q4	



Ø 500 mm

Náhradní stínítko/spare shade/запасное стекло

Kód/code/код	Typ/Type/тип	D [mm]
20512	PM19	500

lankový závěs / wire pendant / гибкий подвес / Seilaufhängung/Suspension par fil

typ/type	délka/length [mm]
L100	1000
L 200	2000

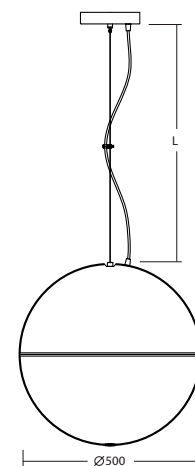



PRŮMYSLOVÁ SVÍTIDLA
INDUSTRY LIGHTING FITTINGS
ПРОМЫШЛЕННЫЕ СВЕТИЛЬНИКИ
INDUSTRIELEUCHTEN
LUMINAIRE INDUSTRIEL

ELEKTRA 1,2	196-197
ELEKTRA 3,3K,3L	198-199
ELEKTRA 4,5	200-201
ELEKTRA 6	202-203
META	204-205

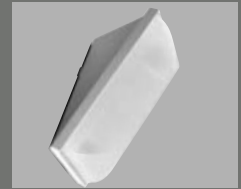

ELEKTRA 1,2



ELEKTRA 3,3K,3L



ELEKTRA 4,5



ELEKTRA 6



META L

CZ POPIS SVÍTIDEL:

Svítidla tvoří montura a stínítko z polykarbonátu nebo polypropylenu	
Montura	- polypropylenový výlisek – IP53,IP54 (ELEKTRA 1,2,3) - polykarbonátový výlisek – IP65 (ELEKTRA 4,5,6)
Stínítko	- čirý polykarbonát – ODOLNOST PROTI NÁRAZU JE 44 Nm (IK10) ELEKTRA 3,4,5,6 - opálový polypropylen – ELEKTRA 1,2
Držení stínítka	- bajonetové, šroubkové
Montáž	- na stěnu nebo na strop
Použití	- garáže, průmyslové prostory, venkovní osvětlení

EN DESCRIPTION OF THE LIGHTING FITTINGS:

The light fittings consist of the fixture and polycarbonate or polypropylene shade	
Fixture	- polypropylene moulding – IP 53,IP54 (ELEKTRA 1,2,3) - polycarbonate moulding – IP 65 (ELEKTRA 4,5,6)
Shade	- polycarbonate transparent – SHOCK RESISTANCE IS 44 Nm (IK10) ELEKTRA 3,4,5,6 -opal polypropylene – ELEKTRA 1,2
Shade attachment	- with bayonet, screws
Assembly	- on the wall or to the ceiling
Applications	- garages, industrial premises, outdoor premises

RUS ОПИСАНИЕ СВЕТИЛЬНИКОВ:

Светильники состоят из основания и светорассеивателя из поликарбоната или полипропилена	
Основание	- полипропилен – IP53,IP54 (ELEKTRA 1,2,3) - поликарбонат – IP65 (ELEKTRA 4,5,6)
Светорассеиватель	- прозрачный поликарбонат – УДАРОПРОЧНОСТЬ составляет 44 Nm (IK10) ELEKTRA 3,4,5,6 - опаловый полипропилен – ELEKTRA 1,2
Крепление рассеивателя	- резьбовое соединение «байонет», винты
Установка	- настенный,потолочный
Назначение	- гаражи, промышленные помещения, наружное освещение

DE BESCHREIBUNG DER LEUCHTEN:

Die Leuchten bestehen aus einer Armatur und einer Polykarbonat- oder Polypropylenabdeckung	
Armatur	- Polypropylenpressteil – IP 53, IP 54 (ELEKTRA 1,2,3) - Polykarbonatpressteil – IP 65 (ELEKTRA 4,5,6)
Abdeckung	- klares Polykarbonat – STOßBESTÄNDIGKEIT BETRÄGT 44Nm (IK10) ELEKTRA 3,4,5,6 - Opalpolypropylen – ELEKTRA 1,2
Halterung der Abdeckscheibe	- Bajonettverschluss, Schraubhalterungen
Montage	- als Wand- und Deckenleuchten
Einsatz	- Garagen, Industriebauten, Außenbeleuchtung

F DESCRIPTION DES LUMINAIRES

Les luminaires se composent d'une monture et d'un abat-jour en polycarbonate ou en polypropylène	
Monture	- polypropylène moulé – IP 53, IP 54 (ELEKTRA 1,2,3) - polycarbonate moulé – IP 65 (ELEKTRA 4,5,6)
Abat-jour	- polycarbonate transparent – RÉSISTANCE AUX CHOCS DE 44Nm (IK10) ELEKTRA 3,4,5,6 - polypropylène opal – ELEKTRA 1,2
Fixation de l'abat-jour	- par baïonnette, par vis
Montage	- sur mur ou sur plafond
Utilisation	- Garages, locaux industriels, extérieurs



ELEKTRA 1,2

**POPIS SVÍTIDEL**

Svítidla tvoří montura a stínítko z polypropylenu
 Držení stínítka - šroubkové
 Montáž - na stěnu ve dvou polohách

DESCRIPTION OF THE LIGHTING FITTINGS

The light consist of the fixture and polypropylene shade
 Shade attachment - with screws
 Assembly - on the wall in two positions

ОПИСАНИЕ СВЕТИЛЬНИКОВ

Светильники состоят из основания и светорассеивателя из полипропилена
 Крепление рассеивателя - винтовое соединение
 Способ установки - настенный (два положения)

BESCHREIBUNG DER LEUCHTEN

Die Leuchten bestehen aus einer Polypropylenarmatur und einer Polypropylenabdeckung
 Halterung der Abdeckscheibe - Schraubenhalterungen
 Montage - als Wandleuchten in zwei Positionen



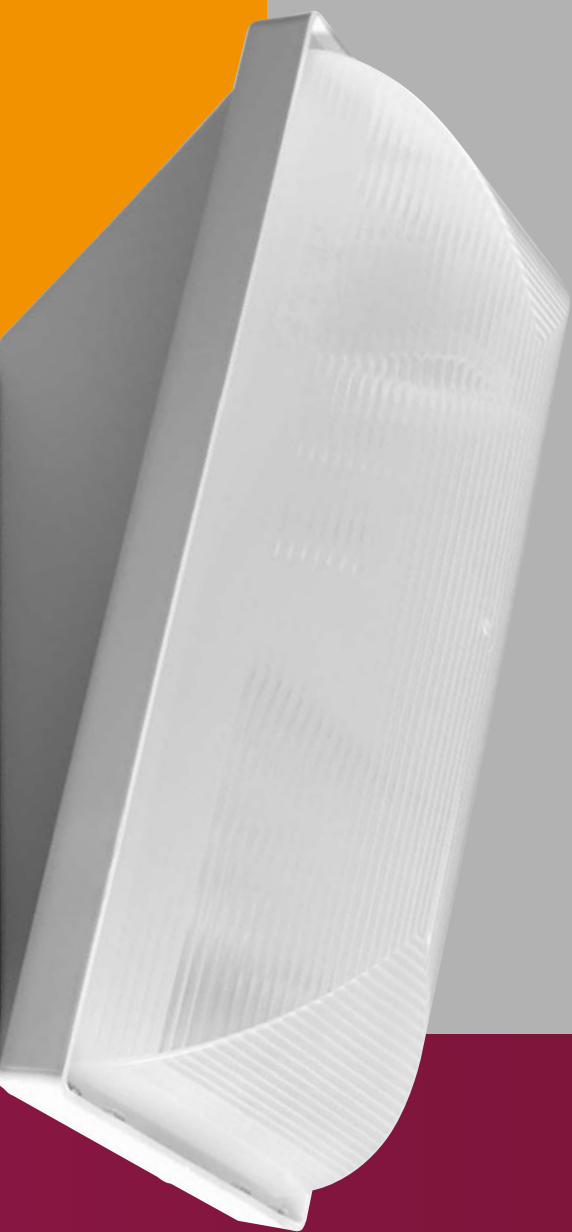

DESCRIPTION DES LUMINAIRES

Les luminaires se composent d'une monture et d'un abat-jour en polypropylène
 Fixation de l'abat-jour - par vis
 Montage - sur un mur à deux positions



ELEKTRA 1

ELEKTRA 1 IP54





Kód code код	typ type тип	Zdroj source лампа	přikon input [W]	objímka socket патрон	T [h]
VVG					
50000	IN-64/9		9	G23	
50001	IN-64/13		13	G24d1	
EVG					
50075	E-64/9		9	2G7	
50076	E-64/13		13	G24q1	

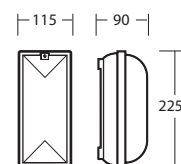

115x225 mm



ELEKTRA 2 IP54

Kód code код	typ type тип	Zdroj source лампа	přikon input [W]	objímka socket патрон	T [h]
VVG					
50002	IN-63/9		9	G23	
50003	IN-63/13		13	G24d1	
EVG					
50077	E-63/9		9	2G7	
50078	E-63/13		13	G24q1	



115x225 mm

Náhradní stínítko/spare shade/запасное стекло

Kód/code/код	Typ/Type/тип	a x b/размер [mm]
20501	64,63	115x225

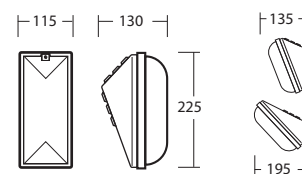

ELEKTRA

3,3L,3K



POPIS SVÍTIDEL

svítidlo tvoří montura z polypropylenu a stínítka z polykarbonátu
 Držení stínítka - bajonetové
 Doplnky - ochranný kovový koš Elektra 3K
 - plastový dekorativní límeček Elektra 3L

DESCRIPTION OF THE LIGHTING FITTINGS

The light fittings consist of the polypropylene fixture and the polycarbonate shade
 Shade attachment - with bayonet
 Accessories - safety metal grid ELEKTRA 3K
 - plastic decorative ring ELEKTRA 3L

ОПИСАНИЕ СВЕТИЛЬНИКОВ

Светильник состоит из пластикового основания (полипропилен) и светорассеивателя из поликарбоната
 Крепление рассеивателя - резьбовое соединение «байонет»
 Аксессуары - металлическая защитная решетка - Elektra 3K,
 - декоративное пластиковое кольцо - Elektra 3L

BESCHREIBUNG DER LEUCHTEN

Die Leuchten bestehen aus einer Polypropylenarmatur und einer Polykarbonatabdeckung
 Halterung der Abdeckscheibe - Bajonettverschluss
 Zubehör - Metallschutzkorb ELEKTRA 3K
 - Dekorativer Kunststoffring - ELEKTRA 3L





DESCRIPTION DES LUMINAIRES

Les luminaires se composent d'une monture polypropylène et d'un abat-jour en polycarbonate
 Fixation de l'abat-jour - par baïonnette
 Accessoires - cache de protection en acier ELEKTRA 3K
 - Col décoratif en plastique ELEKTRA 3L



ELEKTRA 3

ELEKTRA 3 IP53



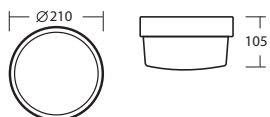

Kód bílá code white код	typ type тип	Kód hnědá code brown код	typ type тип	Zdroj source лампа	přikon input [W]	objímka socket патрон	T [h]
A 							
50004	IN-152B	50008	IN-152H		60	E27	
VVG							
50005	IN-153B	50009	IN-153H		13	G24d1	
EVG							
50006	E-153B	50010	E-153H		13	G24q1	
N							
50007	NZ-7/IN-152B	50011	NZ-7/IN-152H		7	2G7	1,0



Ø 210mm

ELEKTRA 3L

ELEKTRA 3L IP53



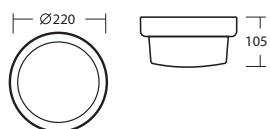

Kód bílá code white код	typ type тип	Kód hnědá code brown код	typ type тип	Zdroj source лампа	přikon input [W]	objímka socket патрон	T [h]
A 							
50012	IN-152LB	50016	IN-152LH		60	E27	
VVG							
50013	IN-153LB	50017	IN-153LH		13	G24d1	
EVG							
50014	E-153LB	50018	E-153LH		13	G24q1	
N							
50015	NZ-7/IN-150LB	50019	NZ-7/IN-152LH		7	2G7	1,0



Ø 220mm

ELEKTRA 3K

ELEKTRA 3K IP53

Kód bílá code white код	typ type тип	Kód hnědá code brown код	typ type тип	Zdroj source лампа	přikon input [W]	objímka socket патрон	T [h]
A 							
50020	IN-152KB	50024	IN-152KH		60	E27	
VVG							
50021	IN-153KB	50025	IN-153KH		13	G24d1	
EVG							
50022	E-153KB	50026	E-153KH		13	G24q1	
N							
50023	NZ-7/IN-150KB	50027	NZ-7/IN-152KH		7	2G7	1,0

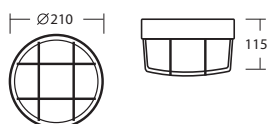

Ø 210mm

Náhradní stínítko/spare shade/запасное стекло

Kód/code/код	Typ/Type/тип	D [mm]
20500	150,152	210

ELEKTRA 4,5

**POPIS SVÍTIDEL**

svítidlo tvoří montura a stínítka z polykarbonátu a kovový ochranný koš

- Držení stínítka - šroubkové
Ochranný koš - kovový bíle lakovaný

DESCRIPTION OF THE LIGHTING FITTINGS

The light fittings consist of the fixture, polycarbonate shade and the safety grid

- Shade attachment - with screws
Safety grid - metal white paint

ОПИСАНИЕ СВЕТИЛЬНИКОВ

Светильник состоит из основания и светорассеивателя из поликарбоната, а также металлической защитной решетки.

- Крепление рассеивателя - винтовое соединение
Металлическая защитная решетка, покрытая белым лаком

BESCHREIBUNG DER LEUCHTEN

Die Leuchten bestehen aus einer Armatur, einer Polykarbonatabdeckung und einem Metallschutzkorb

- Halterung der Abdeckscheibe - Schraubenhalterungen
Schutzkorb - Metallschutzkorb weiß lackiert

DESCRIPTION DES LUMINAIRES













Les luminaires se composent d'une monture, d'un abat-jour en polycarbonate et d'un cache de protection en acier

- Fixation de l'abat-jour - par vis
Cache de protection - métallique laqué blanc



ELEKTRA 4

ELEKTRA 4 IP65

Kód code код	typ type тип	Zdroj source лампа	přikon input [W]	objímka socket патрон	T [h]
A 					
50028	IN-172		100	E27	
VVG					
50029	IN-173/13		13	G24d1	
50030	IN-173/18		18	G24d2	
50031	IN-173/26		26	G24d3	
50032	IN-173/213		2x13	2xG24d1	
EVG					
50034	E-173/13		13	G24q1	
50035	E-173/18		18	G24q2	
50036	E-173/26		26	G24q3	
50037	E-173/213		2x13	2xG24q1	
S					
46133	IN-172 HF		60	E27	
N					
50038	NZ-13/IN-172		13	G24q1	1,0







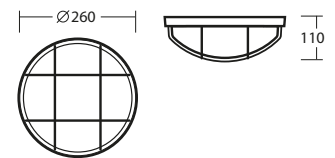







Náhradní stínítko/spare shade/запасное стекло

Kód/code/код	Typ/Type/тип	D [mm]
20502	172, 172L4	260



ELEKTRA 5

ELEKTRA 5 IP65

Kód code код	typ type тип	Zdroj source лампа	přikon input [W]	objímka socket патрон	T [h]
A 					
50039	IN-174		2x60	2xE27	
VVG					
50040	IN-175/18		18	G24d2	
50041	IN-175/26		26	G24d3	
50042	IN-175/213		2x13	2xG24d1	
EVG					
50044	E-175/18		18	G24q2	
50045	E-175/26		26	G24q3	
50046	E-175/218		2x18	2xG24q2	
S					
46134	IN-174 HF		60	E27	
N					
50047	NZ-18/IN-174		18	G24q2	1,0
NE					
50051	NK-E-18/IN-174		18	G24q2	1,0
50052	NK-E-26/IN-174		26	G24q3	1,0



Náhradní stínítko/spare shade/запасное стекло

Kód/code/код	Typ/Type/тип	D [mm]
20503	174	310

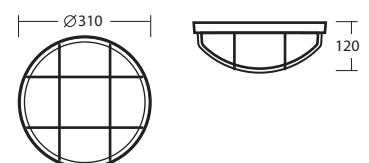

ELEKTRA 6

**POPIS SVÍTIDEL**

svítidlo tvoří montura, stínítka a dekorativní límec z polykarbonátu
Držení stínítka - šroubkové

DESCRIPTION OF THE LIGHTING FITTINGS

The light fittings consist of the fixture, shade and polycarbonate decorative ring
Shade attachment - with screws

ОПИСАНИЕ СВЕТИЛЬНИКОВ

Светильник состоит из основания, светорассеивателя и декоративного кольца из поликарбоната.
Крепление рассеивателя - винтовое соединение

BESCHREIBUNG DER LEUCHTEN













Die Leuchten bestehen aus einer Armatur, einer Abdeckung und einem dekorativen Polykarbonatring
Halterung der Abdeckscheibe - Schraubenhalterungen

DESCRIPTION DES LUMINAIRES

Les luminaires se composent d'une monture, d'un abat-jour et d'un col décoratif en polycarbonate
Fixation de l'abat-jour - par vis



ELEKTRA 6 IP65

Kód code код	typ type тип	Zdroj source лампа	přikon input [W]	objímka socket патрон	T [h]
A 					
50053	IN-172/L4		100	E27	
VVG					
50054	IN-173/13/L4		13	G24d1	
50055	IN-173/18/L4		18	G24d2	
50056	IN-173/26/L4		26	G24d3	
50057	IN-173/213/L4		2x13	2xG24d1	
EVG					
50059	E-173/13/L4		13	G24q1	
50060	E-173/18/L4		18	G24q2	
50061	E-173/26/L4		26	G24q3	
50062	E-173/213/L4		2x13	2xG24q1	
S					
46135	IN-172/L4 HF		60	E27	
N					
50063	NZ-13/IN-172/L4		13	G24q1	1,0



Ø 320 mm

Náhradní stínítko/spare shade/запасное стекло

Kód/code/код	Typ/Type/тип	D [mm]
20502	172, 172L4	260

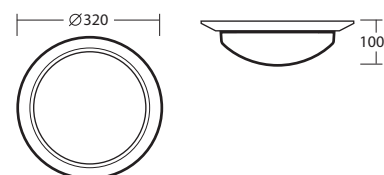

META META L



POPIS SVÍTIDEL

svítidlo tvoří montura z polypropylenu a stínítka z polykarbonátu

Držení stínítka

- bajonetové

Doplňky

- plastový dekorativní límeč

DESCRIPTION OF THE LIGHTING FITTINGS

The light fittings consist of the polypropylene fixture and the polycarbonate shade

Shade attachment

- with bayonet

Accessories

- plastic decorative ring

ОПИСАНИЕ СВЕТИЛЬНИКОВ

Светильник состоит из пластикового основания (полипропилен) и светорассеивателя из поликарбоната

Крепление рассеивателя - резьбовое соединение «байонет»

Аксессуары

- декоративное пластиковое кольцо

BESCHREIBUNG DER LEUCHTEN

Die Leuchten bestehen aus einer Polypropylenarmatur und einer Polykarbonatabdeckung

Halterung der Abdeckscheibe - Bajonettverschluss

Zubehör

- Dekorativer Kunststoffring

DESCRIPTION DES LUMINAIRES

Les luminaires se composent d'une monture polypropylène et d'un abat-jour en polycarbonate

Fixation de l'abat-jour - par baïonnette





Accessoires

- Col décoratif en plastique



META

META IP20

Kód bílá code white код	typ type тип	Kód hnědá code brown код	typ type тип	Zdroj source лампа	příkon input [W]	objímka socket патрон	T [h]
A 							
45016	IN-150B	45019	IN-150H		60	G27	
VVG							
45017	IN-151B	45020	IN-151H		13	G24d1	
N							
45018	NZ-7/IN-150B	45021	NZ-7/IN-150H		7	2G7	1,0





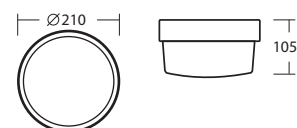

Ø 210mm



META L

META L IP20

Kód bílá code/white ко	typ type тип	Kód hnědá code brown код	typ type тип	Zdroj source лампа	příkon input [W]	objímka socket патрон	T [h]
A 							
45022	IN-150LB	45025	IN-150LH		60	G27	
VVG							
45023	IN-151LB	45026	IN-151LH		13	G24d1	
N							
45024	NZ-7/IN-150LB	45027	NZ-7/IN-150LH		7	2G7	1,0



Ø 220mm

Náhradní stínítko/spare shade/запасное стекло

Kód/code/код	Typ/Type/тип	D [mm]
20500	150,152	210

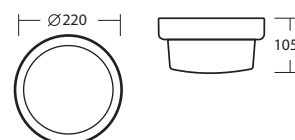



POPISY LED SVÍTIDEL

DESCRIPTIONS OF LED LIGHTING FITTINGS

ОПИСАНИЕ СВЕТОДИОДНЫХ СВЕТИЛЬНИКОВ

LED-LEUCHTENBESCHREIBUNGEN

DESCRIPTION DES LUMINAIRES LED

SVÍTIDLA SE ZDROJI LED

Popis:

Nabídka svítidel s LED zdroji je ve 2 základních skupinách:

- 1) Svítidla s nízkovýkonými LED (cca 0,5W/LED)**
 - Zdrojem světla ve svítidlech jsou LED moduly vlastní konstrukce L11, L12, L13, L14, L26 které jsou osazeny různými počty LED zdrojů (dle typu modulu) od firmy Osram nebo Samsung.
 - Moduly jsou napájeny proudem 700mA.
 - Teplota chromatičnosti 3000K (Ra>80) nebo 4000K (Ra>80).
 - Záruka 3 roky
- 2) Svítidla s vysokovýkonými LED (cca 3W/LED)**
 - Zdrojem světla ve svítidlech je LED modul vlastní konstrukce L02A, který je osazen dvěma LED zdroji od firmy CREE.
 - Modul je napájen proudem 700mA (označení L02A07) nebo proudem 1050mA (označení L02A10).
 - Teplota chromatičnosti 3000K (Ra>80) nebo 4000K (Ra>70).
 - Standardní záruka 5 let,
 - „TOP“ provedení – svítidlo lze připojit na střídavé i stejnosměrné napětí, **záruka 7 let.** (typy označené *)

Počet a konstrukce modulů použitých v jednotlivých typech svítidel určují světelný výkon a zároveň zajišťují optimální teplotní podmínky ve svítidle. Tím je zaručena dlouhodobá životnost LED zdrojů.

Rozmístění modulů umožňuje rovnoměrné osvětlení plochy stínítka bez nežádoucích stínů.

Výhody svítidel Osmont s opalovými stínítky a s LED zdroji

- úsporná svítidla, která díky trojnásobnému lomu světla na stínítku neoslňují
- vhodné pro spínání senzorem – okamžitý start do plného výkonu
- vysoký počet spínacích cyklů – bez omezení
- účinnost LED zdrojů až 120lm/W při provozních teplotách
- životnost LED ve svítidlech je min. 50 000 hod s nepatrnou změnou světelného výkonu
- životnost použitých proudových zdrojů je minimálně 50 000 hodin.
- bezúdržbový provoz – není nutné měnit světelné zdroje
- možnost volby teplot chromatičnosti (3000K, 4000K)
- svítidla se zdroji bez škodlivých látek

DALŠÍ VARIANTY LED SVÍTIDEL

- stmívatelné

výkon LED zdrojů ve svítidle lze řídit nízkým napětím 1-10V nebo digitálně – tlačítkem i systémem DALI (včetně corridor funkce)

Příklad: LED-3L02A10K53/042 1-10V 4000, LED-3L02A10K53/042 DALI 4000

- senzorové

LED zdroje ve svítidle jsou spínány integrovaným vysokofrekvenčním senzorem pohybu

Příklad: LED-3L02A10K53/042 HF 4000

- nouzové

nouzové LED svítidlo se zdrojem o výkonu 1W svítí pouze v nouzovém režimu po dobu 1 hodiny,

Příklad: LED-NZ1W... - světelný tok 100lm

- nouzové kombinované

LED svítidlo je vybaveno dalším LED zdrojem o výkonu 1W, který pracuje v nouzovém režimu po dobu 3 hodin

Zakázkově lze vyrobit i na dobu 1 nebo 2 hodin a výkonu 2 nebo 4W

Příklad: LED-4L02A10K64/062/NK1W 3000 - světelný tok v nouzovém režimu 100lm

LIGHTING WITH LED SOURCES

Description:

The offer of the lighting fittings is in two basic groups:

- 1) Lighting with low efficient LED (ca 0,5W/LED)**
 - The light source in the lamp is a LED module of our own design L11, L12, L13, L14, L26, fitted with different numbers of LED sources (according to module type) from Osram or Samsung company
 - Modules are supplied by power of 700mA (marked as L02A07) or by power of 1050mA (marked as L02A10).
 - Chromaticity temperatures are 3000 K (Ra> 80) or 4000K (Ra >70)
 - Guarantee is 3 years
- 2) Lighting with high efficient LED modules (ca 3W/LED)**
 - The light source in the lamp is a LED module of our own design L02A, fitted with two LED sources made by the company CREE.
 - Modules are supplied by power 700mA
 - Chromaticity temperatures are 3000 K (Ra> 80) or 4000K (Ra >70)
 - Standard guarantee 5 years
 - „TOP“ version – the lighting is possible to connect to AC/DC voltage, **7 years of guarantee** (types are marked as *)

The number and construction of the modules used in each type of the lamp determine the light output and at the same time provide the optimum temperature conditions in the lamp. This ensures long service life of the LED sources. The arrangement of the modules enables even lighting of the shield area without unwanted shades.

Advantages of the Osmont lamps with opaline shields and LED sources CREE

- energy-saving lamps, which do not dazzle thanks to the triple refraction on the shield
- suitable for sensor switching – quick start-up to the full output –
- high number of switching cycles – unlimited
- high efficiency of the LED up to 120lm/W at working hours
- the service life of the LEDs in the lamps is at least 50,000 hours with hardly noticeable change of the light output
- the service life of the power supply used is at least 50,000 hours
- maintenance-free operation – the light sources do not need changing
- possibility to choose from chromaticity temperatures (3000K, 4000K)

- lamps with the sources without harmful substances

Other variants of LED lighting fittings

- dim

The power of the LED sources in the lamps is controlled by means of low voltage 1-10 or digital – switch and the DALI system (incl. corridor function)

Example: LED-3L02A10K53/042 1-10V 4000, LED-3L02A10K53/042 DALI 4000

- sensor

LED sources in the lamp are switched by means of high-frequency motion sensor

Example: LED-3L02A10K53/042 HF 4000

- emergency

Emergency LED lamp shines only in emergency mode for 1 hour

Example: LED-NZ1W...LED luminous flux – 100lm

- Combined emergency

LED lamp is equipped with an additional LED source of an input of 1w, which works in emergency mode for 3 hours

On request it is possible to manufacture a lamp for 1 or 2 hours of an input 2 or 4W

Example: LED-4L02A10K64/062/NK1W 3000 - luminous flux in emergency mode 100lm

СВЕТОДИОДНЫЕ СВЕТИЛЬНИКИ (LED)

Описание:

Светодиодные светильники предлагаются в двух основных вариантах:

- 1) Светильники с менее мощными светодиодами (примерно 0,5W/LED)**
 - Источником света являются светодиодные модули собственной конструкции L11, L12, L13, L14, L26 которые оснащены различным количеством светодиодов (в соответствии с типом модуля) производства компаний Osram или Samsung.
 - Модуль питается током 700mA.
 - Индекс цветопередачи 3000K (Ra>80) или 4000K (Ra>80).
 - Гарантия 3 года
- 2) Светильники с высококачественными светодиодами (примерно 3W/LED)**
 - Источником света являются светодиодные модули собственной конструкции L02A, которые оснащаются двумя светодиодами производства компании CREE.
 - Модуль питается током 700mA (обозначение L02A07) или током 1050mA (обозначение L02A10).
 - Индекс цветопередачи 3000K (Ra>80) или 4000K (Ra>70).
 - Стандартный гарантийный срок 5 лет, под заказ светильник может быть оснащен „TOP“ компонентами с **гарантийным сроком 7 лет.** (типы обозначенные *)

Качество и конструкция модулей, используемых в конкретных типах светильников определяет мощность светового потока и одновременно с этим обеспечивает оптимальный температурный режим внутри светильника. Таким образом гарантируется долговечность светодиодных источников света. Размещение модулей позволяет равномерно осветить поверхность светорассеивателя избежав возникновения неосвещенных участков.

Достоинства светильников Osmont с опаловыми светорассеивателями со светодиодами

- экономичность светильников, которые благодаря тройному преломлению света в светорассеивателе не ослепляют
- подходят для применения с датчиком движения – мгновенный старт на полную мощность
- высокая эффективность 120lm/W при рабочих температурах
- долговечность светодиодов в светильниках составляет как минимум 50 000 часов с незначительным изменением светоотдачи
- долговечность применяемых источников тока составляет как минимум 50 000 часов
- не требуют сервисного обслуживания – нет необходимости менять лампы
- возможность выбора индекса цветопередачи (3000K, 4000K)
- светильники с источниками света без вредных веществ

ВОЗМОЖНЫЕ ВАРИАНТЫ СВЕТОДИОДНЫХ СВЕТИЛЬНИКОВ

- регулируемые

мощность свечения светодиодов может регулироваться аналоговым потенциометром 1-10V или цифровым путем – клавишей и системой DALI (включая функцию –коридор)

Пример: LED-3L02A10K53/042 1-10V 4000, LED-3L02A10K53/042 DALI 4000

- с высокочастотным датчиком движения

светодиоды в светильнике включаются вмонтированным высокочастотным датчиком движения

Пример: LED-3L02A10K53/042 HF 4000

- аварийные

аварийный светодиодный светильник со светодиодом мощностью 1W светит только в аварийном режиме в течении 1 часа,

Пример: LED-NZ1W... – световой поток 100lm

- аварийные-комбинированные

светодиодный светильник дополнительно оснащен ещё одним светодиодом мощностью 1W, который работает в аварийном режиме в течении 3 часов

Под заказ возможно изготовление светильника для работы в аварийном режиме в течении 1 или 2 часов и мощностью 2 или 4W

Пример: LED-4L02A10K64/062/NK1W 3000 – световой поток в аварийном режиме 100lm

LEUCHTEN MIT LED-LAMPEN

Angebot über LED-Leuchten in 2 Grundklassen:

1) Leuchten mit leistungsschwachen LED (ca. 0,5 W/LED)

- Lichtquellen in den Leuchten sind die LED-Module L11, L12, L13, L14, L26 eigener Konstruktion, die mit unterschiedlicher Anzahl von LED (je nach dem Modultyp) von der Firma Osram oder Samsung bestückt sind.

- Die Module werden mit Strom von 700 mA versorgt.
 - Die Chrominanz beträgt 3000 K (Ra>80) oder 4000 K (Ra>80).
 - 3 Jahre Garantie
- 2) Leuchten mit leistungsstarken LED (ca. 3 W/LED)**
- Die Lichtquelle in den Leuchten ist das LED-Modul LO2A eigener Konstruktion, das mit zwei LED-Lampen von der Firma CREE bestückt ist.
 - Das Modul wird mit Strom von 700 mA (Bezeichnung LO2A07) oder 1050 mA (Bezeichnung LO2A10) versorgt.
 - Die Chrominanz beträgt 3000K (Ra>80) oder 4000 K (Ra>70).
 - Standardgarantie 5 Jahre,
 - Auf Bestellung kann die Leuchte mit „TOP“-Komponenten und 7 Jahren Garantie ausgestattet werden (mit * gekennzeichnete Typen)

Die Anzahl sowie die Konstruktion der in den einzelnen Leuchttypen verwendeten Module bestimmen die Lichtleistung und sorgen zugleich für optimale Temperaturbedingungen in der Leuchte. Dadurch ist die lange Lebensdauer der LED-Quellen gewährleistet.

Die Anordnung der Module ermöglicht eine gleichmäßige Beleuchtung der Schirmfläche ohne unerwünschte Schatten.

Vorteile der Osmont-Leuchten mit Opalschirmen und LED-Quellen

- Energiesparleuchten, die dank der dreifachen Lichtbrechung am Schirm nicht blenden
- geeignet für Sensorschaltung – sofortiger Anlauf der Vollleistung
- hohe Anzahl der Schaltzyklen – uneingeschränkt
- Wirkungsgrad der LED-Quellen beträgt 120lm/W bei Betriebstemperatur
- die Lebensdauer der LED-Quellen in den Leuchten beträgt mind. 50.000 Stunden mit geringer Änderung der Lichtleistung
- die Lebensdauer der verwendeten Stromquellen beträgt mindestens 50.000 Stunden
- wartungsfreier Betrieb – die Lichtquellen müssen nicht ausgetauscht werden
- Option für mehrere Farbtemperaturen (3000K, 4000K)
- Leuchten mit LED-Quellen ohne Schadstoffe

WEITERE VARIANTEN DER LED-LEUCHTEN

- LED-Leuchten mit Leistungsregelung

Die Leistung der LED-Quellen in der Leuchte kann durch niedrige Spannung von 1-10V oder digital mittels einer Taste oder auch durch das DALI-System (einschl. der Corridor-Funktion) geregelt werden.

Beispiel: LED-3LO2A10K53/042 1-10V 4000, LED-3LO2A10K53/042 DALI 4000)

- LED-Leuchten mit Bewegungssensor

Die LED-Quellen in der Leuchte werden durch den Hochfrequenz-Bewegungssensor geschaltet.

Beispiel: LED-3LO2A10K53/042 HF 4000

- LED-Notleuchten

Die LED-Notleuchte leuchtet nur im Notbetrieb auf die Dauer für 1 Stunde

Beispiel: LED-NZ1W... – Lichtstrom 100lm

- kombinierte LED-Notleuchten

Die LED-Leuchte ist mit einer weiteren LED-Quelle mit einer Leistung von 1W, die im Notbetrieb für die Dauer von 3 Stunden lang arbeitet

Auf Bestellung können die Brenndauer 1 oder 2 Stunden und die Leistung 2 oder 4 W betragen

Beispiel: LED-4LO2A10K64/062/NK1W 3000 – Lichtstrom im Notbetrieb 100lm

LES LUMINAIRES LED

L'offre des luminaires avec LED se trouve dans deux groupes de base:

1) Lampes à basse consommation LED (environ 0,5 W / LED)

- La source de lumière dans les luminaires sont des modules LED de conception personnalisée L11, L12, L13, L14, L26, qui sont équipés de quantités différentes de LED (selon le type de module) de la société Osram ou Samsung.
- Les modules sont branchés 700mA de courant.
- La température de couleur est de 3000K (Ra> 80) ou de 4000K (Ra> 80).
- 3 ans de garantie

2) Luminaires LED à haute performance (env. 3W/LED)

- La source de lumière dans les luminaires est un module LED LO2A de conception personnalisée, qui est équipé de deux sources LED de la société CREE.
- La tension qui alimente le LED est de 700mm (marqué LO2A07) ou de 1050 mA (marqué :
- La température de couleur est de 3000K (Ra> 80) ou de 4000K (Ra> 70).
- La garantie standard est de 5 ans,
- Version „TOP“ - le luminaire peut être connecté à la fois sur courant alternatif et courant continu, 7 ans de garantie. (* types marqués)

Le nombre et la conception des modules utilisés dans chaque type de luminaires déterminant la puissance de la luminosité en fournissant des conditions optimales thermiques pour chaque luminaire.

Ceci assure une longue durée de vie des LED.

L'emplacement des modules rend possible une importante zone d'éclairage sans ombres indésirables.

Avantages des luminaires Osmont avec abat-jour en opal et source LED

- Luminaires à basse consommation, qui grâce à une triple réfraction de la lumière empêche l'éblouissement
- convient pour un capteur - démarrage immédiat à pleine puissance
- nombre élevé de cycles de commutation - pas de restriction
- efficacité des LED 120lm / W température de fonctionnement
- la durée de vie des LED des luminaires est d'un minimum de 50.000 heures avec un léger changement dans la production de lumière .
- Fonctionnement sans entretien - pas besoin de changer la source de lumière
- Possibilité de choix des températures chromatiques (3000K, 4000K)
- La source lumineuse est exempte de substances nocives

Autres variantes des source lumineuse LED

- Possibilité de changement de la puissance lumineuse

la puissance lumineuse des sources LED dans les luminaires peut être commandée par basse tension 1-10V ou numériquement par le système DALI (y compris la fonction de corridor)

Exemple LED-3LO2A10K53/042 1-10V 4000, LED-3LO2A10K53/042 DALI 4000)

- Senseur

la source LED des luminaires se déclenche par un capteur de mouvement intégré à haute fréquence

Exemple: LED-3LO2A10K53/042 HF 4000

- De secours

Les luminaires de secours avec source LED sont allumés seulement en régime de secours pendant une période de 1 heure,

Exemple: LED-NZ1W... – flux lumineux 100 lm

- De secours mixte

Le luminaire avec LED est équipé d'une autre source LED de puissance 1W qui fonctionne en cas de régime de secours pendant une période de 3 heures.

Exemple: LED-4LO2A10K64/064/NK1W 3000 - flux lumineux pour régime de secours 100 lm

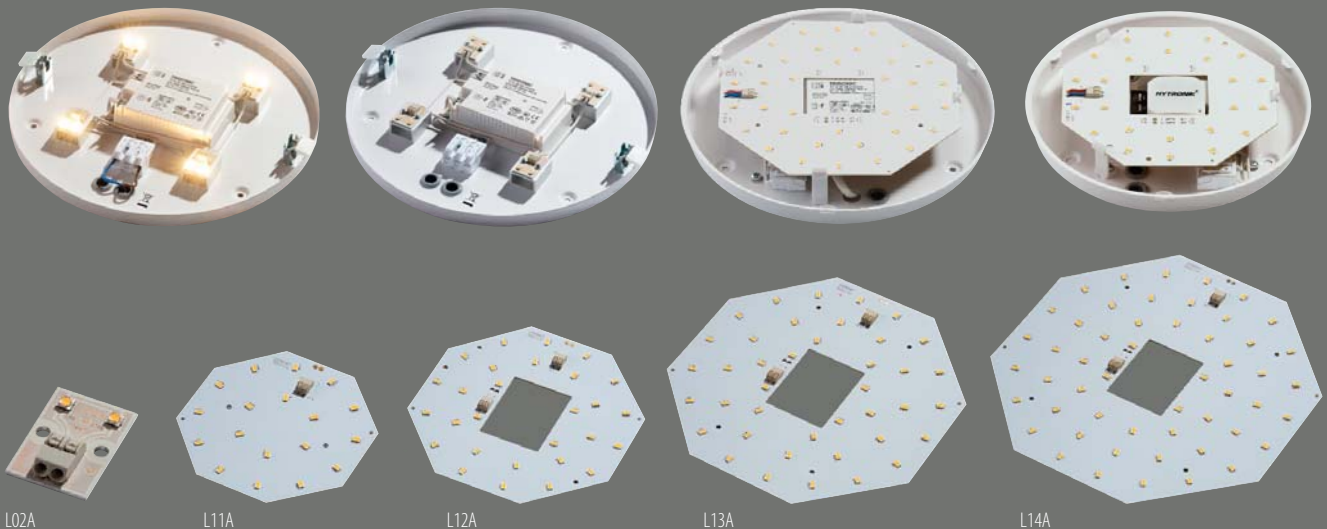

L02A

L11A

L12A

L13A

L14A

SENZOROVÁ SVÍTIDLA/SENSOR LIGHTS





Svítlidla s automatickým spínáním pomocí integrovaného vysokofrekvenčního senzoru
Light fittings with automatic switching by integrated HF sensor

Přednosti svítidel se senzorem/Advantages of sensor lights:

- automatické ,pohodlné spínání svítidla/automatic, comfortable switching the light on
- spínání při nepatrném pohybu bez prodlevy/instantly respond to the slightest movement
- neviditelné umístění senzoru v interiéru/invisibly concealed sensor in the interior
- úspora elektrické energie/save electric energy
- rychlé a snadné nastavení přídržné doby a citlivosti/fast and easy holding time and sensitivity set-up with a button

Vlastnosti/Features:

Detekční úhel/Detection angle	150°
Doba sepnutí/Dwell period	nastavitelná/adjustable: 5s,30s,60s,120s,300s
Dosah/Detection range	max (DMxH) 8 x 6 m
Citlivost na osvětlení/Sensitivity	Ize nastavit podle okolního osvětlení v 5 stupních adjustable according to the outside illumination
Max. zátěž/Max. charge	800 W  400 W 

Doporučení/Advice: Jako zdroj světla doporučujeme použít úsporné kompaktní zdroje s vysokým počtem spínacích cyklů/ Use energy saving compact sources with a high switching-duty cycle number as a light source

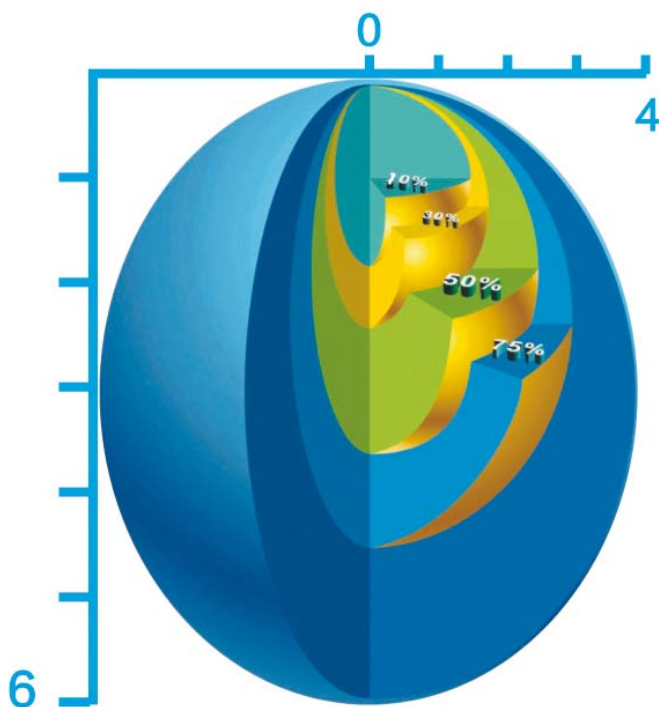

BEZDRÁTOVÉ OVLÁDÁNÍ SVÍTIDEL:

Na zakázku lze svítidla vybavit komponenty pro bezdrátové ovládání světelných zdrojů.

Používáme systém Poseidon® (868MHz), jehož výrobcem je česká firma Enika s.r.o.

Tento systém lze použít především při požadavku na víceokruhové spínání nebo stmívání svítidla v těch prostorech, kde se nenachází vhodná elektroinstalace.

Hlavními částmi systému jsou vysílač a přijímač. Přijímač je zabudován ve svítidle a vysílač může být přenosný (klíčenka), nebo jej lze přichytit (přilepit, přišroubovat) kdekoli na stěnu v prostoru, kde chceme svítidlo ovládat. Systém může být i víceokruhový, tzn. že jím lze ovládat i více svítidel v místnosti. Svítidla lze zapínat, vypínat, nebo plynule regulovat světelný výkon. Vysílače jsou vyráběny ve všech designech vypínačů od firmy ABB, a proto je lze sjednotit se stávajícími vypínači v interiéru.

WIRELESS CONTROL OF THE LIGHTING FITTINGS:

It is possible to equip the lighting fittings with components for wireless control of the luminous lights to the order.

We use Poseidon® (868MHz) system produced by the Czech company of Enika s.r.o.

The system can be used especially where there is the demand of multicircuit switching or dimming of a lighting fitting in the spaces where there is not a suitable wiring.

The main parts of the system are a transmitter and a receiver. The receiver is built in the lighting fitting and the transmitter can be portable (a key pouch) or it can be attached (glued, screwed) anywhere on a wall in the room where we want to control the lighting fitting. The system can be a multicircuit one which means it can control even more lighting fittings in the room. The lighting fittings can be switched on and off or the luminous output can be fluently controlled. The transmitters are produced in all designs of switches by ABB company and so they can be unified with the existing switches in the interior.

ДИСТАНЦИОННОЕ УПРАВЛЕНИЕ СВЕТИЛЬНИКАМИ:

Под заказ светильники могут быть оснащены компонентами для дистанционного управления источниками света.

Применяется система Poseidon® (868MHz), производства чешской компании Enika s.r.o.

Данная система в первую очередь может использоваться в случае необходимости организации многоконтурного включения или регулирования яркости свечения светильника в тех помещениях, в которых отсутствует подходящая электропроводка.

Основными частями светильника являются передатчик и приемник. Приемник встроен в светильник, а передатчик может быть переносной (брелок), или он может быть закреплен (приклеен, прикручен) в любом месте на стене в помещении, в котором планируется управлять светильником. Система может быть и многоконтурной, т.е. она позволяет управлять несколькими светильниками в помещении. Светильники могут включаться, выключаться или регулироваться яркость их свечения. Передатчики изготавливаются во всех дизайнах выключателей компании ABB, и поэтому они легко вписываются в интерьер выключателей в помещении.

DRAHTLOSE LEUCHTENBEDIENUNG:

Auf Bestellung können die Leuchten mit Komponenten für drahtlose Bedienung der Lichtquellen bestückt werden.

Wir verwenden das System Poseidon® (868MHz) vom tschechischen Hersteller Enika s.r.o.

Dieses System kann insbesondere bei gewünschter Mehrkreisschaltung oder bei dimmbaren Leuchten in den Räumlichkeiten eingesetzt werden, wo keine geeignete Elektroinstallation vorhanden ist.

Hauptkomponenten des Systems sind der Sender und der Empfänger. Der Empfänger ist in der Leuchte eingebaut und der Sender kann tragbar (Schlüsselteil) sein oder er kann an beliebige Wandstelle angebracht (angeklebt, angeschraubt) werden, wo man die Leuchte bedienen möchte. Das System kann als Mehrkreisschaltung ausgeführt werden, d.h. dass man damit mehrere Leuchten im Raum bedienen kann. Die Leuchten lassen sich ein- und ausschalten oder man kann damit die Leuchtkraft stufenlos regeln. Die Sender werden in allen Schalterausführungen der Firma ABB hergestellt und können deshalb den im Innenraum bestehenden Schaltern angepasst werden.

COMMANDE SANS FIL DES LUMINAIRES :

Les luminaires fabriqués sur commande peuvent être équipés d'un dispositif de commande sans fil.

Nous utilisons le système Poséidon® (868 MHz), fabriqué par la société tchèque Enika s.r.o.

Ce système est principalement utilisé pour une connection multi-circuit ou pour une graduation de lumière, dans les espaces où le câblage n'est pas approprié.

Les parties principales du système sont un émetteur et un récepteur. Le récepteur est intégré dans le luminaire et l'émetteur peut être portable (clé), ou il peut être fixé (collé, vissé) n'importe où sur le mur à l'espace où nous voulons contrôler la lumière. Le système peut aussi être une connection multi-circuit, c'est à dire qu'elle peut également contrôler plusieurs appareils dans l'espace. Les lampes peuvent être allumées, éteintes ou régler la production de lumière continue. Les émetteurs sont disponibles dans tous les interrupteurs de la société ABB et peuvent donc être intégrés avec les interrupteurs déjà existants dans l'espace.

ORIENTAČNÍ POROVNÁNÍ LED ZDROJŮ SE ŽÁROVKOVÝMI A ZÁŘIVKOVÝMI ZDROJI / COMPARISON OF THE OUTPUT OF LED SOURCES WITH THAT OF BULB AND FLUORESCENT SOURCES / ПРИБЛИЗИТЕЛЬНОЕ СРАВНЕНИЕ СВЕТОДИОДОВ, ЛАМП НАКАЛИВАНИЯ И ЛЮМИНЕСЦЕНТНЫХ ЛАМП / LEISTUNGSABGLEICH DER LED-LAMPEN MIT GLÜH- UND LEUCHSTOFFLAMPEN / COMPARAISON APPROXIMATIVE DE LA PUISSANCE LED ET SOURCES À INCANDESCENCE AVEC DES SOURCES LUMINEUSES FLUORESCENTES

typ type	výkon led output [W]	příkon lamp input [W]	počet LED number of LEDs	světelný tok LED light flux [lm]	žárovka bulb [W]	zářivka fluorescent tube [W]
LED moduly L11A, L12A, L13A, L14A - 700mA						
LED-1L11A07	6,5	9	18	740	75	13
LED-1L12A07	8,7	11	24	980	85	18
LED-1L13A07	13	16	36	1480	110	26
LED-1L14A07	17,3	21	48	1970	170	2x18
LED-4L11A07	26	30	72	2950	250	2x26
LED-4L12A07	34,6	41	96	3940	330	2x36
LED-4L13A07	51,9	59	144	5900	490	3x36
LED-6L13A07	77,8	88	216	8860	740	5x32
LED modul L02A - 700mA						
LED-2L02A07	8,3	11	4	990	85	18
LED-3L02A07	12,4	15	6	1470	110	26
LED-4L02A07	16,7	20	8	1970	170	2x18
LED-5L02A07	20,8	24	10	2460	200	42
LED-6L02A07	25	29	12	2950	250	2x26
LED modul L02A - 1050mA						
LED-3L02A10	19,3	23	6	1970	170	2x18
LED-4L02A10	25,7	30	8	2630	220	2x26
LED-5L02A10	32,1	37	10	3280	270	2x32
LED-6L02A10	38,6	43	12	3940	330	2x36
LED-8L02A10	51,4	58	16	5250	440	2x32
LED-12L02A10	77,1	86	24	7880	660	4x36
LED-16L02A10	115,7	129	36	10510	880	6x32

PŘEHLED POUŽITÍ KOMPAKTNÍCH ZDROJŮ E27 / VIEW OF USING COMPACT LAMPS E27 / ОБЗОР ИСПОЛЬЗОВАНИЯ КОМПАКТНЫХ ЛАМП E27 / ÜBERSICHT ÜBER DEN EINSATZ DER KOMPAKTQUELLEN E27 / PRESENTATION DE L'UTILISATION DES SOURCES COMPACTES E27

SVÍTIDLA SE STÍNÍTKY ZE SKLA TRIPLEX OPÁL

série	kód	typ	žárovka [W]	halogenová žárovka [W]	kompaktní zářivka E27	
					žárovka [W]	max.L/mm
AURA 1	40000	IN-12K2/040	60	42	11	117
	40010	IN-12DU2/040	60	42	11	117
AURA 2	40017	IN-12K52/042	100	70	23	152
	40042	IN-12DU52/042	100	70	20	137
AURA 3	40018	IN-22K52/042	2x60	2x42	2x15	128
	42630	IN-12K63/062	100	70	33	196
AURA 4	40055	IN-22K63/062	2x75	2x52	2x20	137
	40066	IN-22DU63/062	2x60	2x42	2x15	128
AURA 5	40086	IN-22K74/072	2x75	2x52	2x23	152
	40095	IN-32K85/082	3x60	3x42	3x23	152
AURA 9	42400	IN-32K96/084	3x75	3x52	3x30	183
	42800	IN-12K2/051	60	42	15	128
CRATER 1	42808	IN-12DU2/051	60	42	11	117
	42812	IN-12K53/052	100	70	23	152
CRATER 2	42813	IN-22K53/052	2x60	2x42	2x20	137
	42839	IN-12DU53/052	100	70	20	137
CRATER 3	42844	IN-12K64/053	100	70	33	196
	42845	IN-22K64/053	2x75	2x52	2x30	183
CRATER 4	42875	IN-22DU64/053	2x60	2x42	2x23	152
	42880	IN-22K75/054	2x75	2x52	2x33	196
CRATER 5	42896	IN-32K86/055	3x60	3x42	3x33	196
	42915	IN-12K2/251	60	42	15	128
DRACO 1	42923	IN-12DU2/251	60	42	15	128
	42927	IN-12K53/252	100	70	23	152
DRACO 2	42928	IN-22K53/252	2x60	2x42	2x20	137
	42954	IN-12DU53/252	100	70	23	152
DRACO 3	42959	IN-12K64/253	100	70	33	196
	42960	IN-22K64/253	2x75	2x52	2x30	183
DRACO 4	42989	IN-22DU64/253	2x60	2x42	2x30	183
	42995	IN-22K75/254	2x75	2x52	2x33	196
DRACO 5	43012	IN-32K86/255	3x60	3x42	3x33	196
	40104	IN-12B11/011	60	42	x	x
AURA 6	40106	IN-12B12/012	75	52	15	128
AURA 7	40113	IN-12B13/013	100	70	23	152
AURA 8	40114	IN-22B13/013	2x60	2x42	2x15	128
AURA 10	42725	IN-12B14/014	100	70	33	196
	42726	IN-22B14/014	2x75	2x52	2x20	137

série	kód	typ	žárovka [W]	halogenová žárovka [W]	kompaktní zářivka E27	
					žárovka [W]	max.L/mm
AURA 11	40113	IN-22B15/015	2x75	2x52	2x23	152
ELSA 1	44700	IN-12B12/023	75	52	15	128
ELSA 2	44726	IN-12B13/025	100	70	23	152
	44727	IN-22B13/025	2x60	2x42	2x15	128
ELSA 3	44798	IN-12B14/027	100	70	33	196
	44799	IN-22B14/027	2x75	2x52	2x20	137
ELSA 4	44885	IN-22B15/029	2x75	2x52	2x23	152
	41166	IN-12K2/020	60	42	11	117
EDNA 1	41175	IN-12DU2/020	60	42	11	117
	41183	IN-12K52/022	100	70	23	152
EDNA 2	41184	IN-22K52/022	2x60	2x42	2x15	128
	41298	IN-12DU52/022	100	70	20	137
EDNA 3	43028	IN-12K63/024	100	70	33	196
	41221	IN-22K63/024	2x75	2x52	2x20	137
EDNA 4	41232	IN-22DU63/024	2x60	2x42	2x15	128
	43030	IN-22K74/026	2x75	2x52	2x23	152
LINA 1	41252	IN-12K2/033	60	42	15	128
	41262	IN-12DU2/033	60	42	15	128
LINA 2	41269	IN-12K53/035	100	70	23	173
	41270	IN-22K53/035	2x60	42	2x15	126
LINA 3	41294	IN-12DU53/035	100	70	23	173
	43047	IN-12K64/037	100	70	33	196
LINA 6	41307	IN-22K64/037	2x75	2x52	2x15	128
	41318	IN-22DU64/037	2x60	2x42	2x20	145
LINA 4	42310	IN-22K76/039	2x75	2x52	2x23	152
LINA 5	41338	IN-12K2/030	60	42	11	117
	41348	IN-12DU2/030	60	42	11	117
LINA 5	41355	IN-12K53/031	100	70	23	173
	41356	IN-22K53/031	2x60	2x42	2x20	137
ALTAIR 1	41380	IN-12DU53/031	100	70	23	173
	44050	IN-12U20/420	60	42	30	117
ALTAIR 2	44051	IN-22U20/420	2x40	2x28	2x20	137
	44057	IN-12U21/421	60	42	30	117
SYLVIA 1	44058	IN-22U21/421	2x40	2x28	2x20	137
	44070	IN-32U12/129	3x25	3x28	3x11	139
SYLVIA 2	44072	IN-32U12/130	3x25	3x28	3x11	139
	41393	IN-12U8/036	60	42	11	117
JENA 1	41399	IN-12U9/038	100	70	20	145
	41400	IN-22U9/038	2x60	2x42	x	x
NELA 1	41417	IN-12U5/244	60	42	7	113
NELA 2	41421	IN-12U7/264	100	70	20	145
	41422	IN-22U7/264	2x60	2x42	2x11	117

PŘEHLED POUŽITÍ KOMPAKTNÍCH ZDROJŮ E27 / VIEW OF USING COMPACT LAMPS E27 / ОБЗОР ИСПОЛЬЗОВАНИЯ КОМПАКТНЫХ ЛАМП E27 / ÜBERSICHT ÜBER DEN EINSATZ DER KOMPAKTQUELLEN E27 / PRESENTATION DE L'UTILISATION DES SOURCES COMPACTES E27

SVÍTLIDLA SE STÍNÍTKY ZE SKLA TRIPLEX OPÁL

série	kód	typ	žárovka [W]	halogenová žárovka [W]	kompaktní zářivka E27	
					žárovka [W]	max.L/mm
NELA 3	41431	IN-22U7/268	2x60	2x42	2x15	128
NELA 4A	43084	IN-12U31/322	100	70	20	137
LYRA 1	42500	IN-12U4/245	75	52	20	145
LYRA 2	42510	IN-22U6/265	2x75	2x52	2x23	173
NEVA 1	41609	IN-12U8/226	60	42	20	145
NEVA 2	41615	IN-12U9/228	100	70	23	173
	41616	IN-22U9/228	2x60	2x42	2x20	145
ALMA 1	41631	IN-12U1/121	60	42	11	117
ALMA 2	41635	IN-12U2/123	100	70	20	145
	41636	IN-22U2/123	2x60	2x42	2x15	128
PYRAMUS 1	44962	IN-12U3/323	100	70	20	145
PYRAMUS 2	44964	IN-22K65/324	2x60	2x42	2x15	128
PYRAMUS 3	44972	IN-22K65/334	2x60	2x42	2x15	128
ORCUS DK		IN-12K56/472/DK..	100	70	33	196
STYX 1	43971	IN-12BD1/192	75	52	15	128
STYX 2	43972	IN-12BD1/193	75	52	20	145
STYX 3	43973	IN-12BD1/194	100	70	27	174
STYX 4	43975	IN-12BD1/196	150	105	33	196
KIRA 1	41741	IN-12B12/312	75	52	20	137
KIRA 2	41745	IN-12B13/313	100	70	27	174
MIRA D		IN-12S5/195/S..	150	105	33	196

Závěsná svítidla

ADRIA 1,1L,1S	Z11/092/.....	75	52	15	128
ADRIA 2,2L,2S	Z11/094/.....	100	70	27	174
ADRIA 3,3L,3S	Z11/096/.....	150	105	33	196
ADRIA 4,4L,4S	Z11/098/.....	150	105	33	196
ADRIA 5,5L,5S	Z11/099/.....	150	105	33	196
	Z11/3/099/.....	3x60	3x42	3x33	196
DANAE 1	ZS11/5L01/452/L100	40	28	20	137
DANAE 2	ZT11/452/L100	100	70	33	196
DANTE 1	ZS11/5L01/457/L100	40	28	20	137
DANTE 2	Z11/452/a5	100	70	33	196
ASTRA, L,S	Z11/095/.....	150	105	33	196
AURA P3	IN-22ZK63/062/z.	2x75	2x52	2x20	137
AURA P4	IN-22ZK74/072/z.	2x75	2x52	2x23	152
AURA P5	IN-32ZK85/082/z.	3x60	3x42	3x23	152
CRATER P3	IN-22ZK64/053/z.	2x75	2x52	2x20	137
CRATER P4	IN-22ZK75/054/z.	2x75	2x52	2x23	152
CRATER P5	IN-32ZK85/055/z.	3x60	3x42	3x23	152
DRACO P3	IN-22ZK64/253/z.	2x75	2x52	2x20	137
DRACO P4	IN-22ZK75/254/z.	2x75	2x52	2x23	152
DRACO P5	IN-32ZK85/255/z.	3x60	3x42	3x23	152
EDNA P3	IN-22ZK63/024/z.	2x75	2x52	2x20	137
EDNA P4	IN-22ZK74/026/z.	2x75	2x52	2x23	152
EDNA P5	IN-32ZK85/028/z.	3x60	3x42	3x23	152
AURA T5	IN-32ZT85/082/L100	3x60	3x42	3x23	152
AURA T9	IN-32ZT96/082/L100	3x60	3x42	3x23	152
CRATER T5	IN-32ZT85/055/L100	3x60	3x42	3x23	152
DRACO T5	IN-32ZT85/255/L100	3x60	3x42	3x23	152
EDNA T5	IN-32ZT88/028/L100	3x60	3x42	3x23	152
LINA T7	IN-32ZT88/139/L100	3x60	3x42	3x23	152
MIRA R	IN-12S6/195/..	150	105	33	196

Stolní lampy

ACTOR	IN-SL1/251..	60	42	15	128
BIANCA 1	IN-12BD1/192	40	28	8	122
BIANCA 2	IN-12BD1/193	40	28	8	122
BIANCA 3	IN-12BD1/194	60	42	15	128
BIANCA 4	IN-12BD1/196	60	42	15	128
ADELE	SL3/100..	60	42	15	128

PŘEHLED POUŽITÍ KOMPAKTNÍCH ZDROJŮ E27 / VIEW OF USING COMPACT LAMPS E27 / ОБЗОР ИСПОЛЬЗОВАНИЯ КОМПАКТНЫХ ЛАМП E27 / ÜBERSICHT ÜBER DEN EINSATZ DER KOMPAKTQUELLEN E27 / PRESENTATION DE L'UTILISATION DES SOURCES COMPACTES E27

POLYKARBONÁTOVÁ SVÍTLIDLA

série	kód	typ	žárovka [W]	halogenová žárovka [W]	kompaktní zářivka E27	
					žárovka [W]	max.L/mm
TITAN 1A		IN-12KN32/P03	60	42	15	128
TITAN 1		IN-12KN62/P06	60	42	15	126
TITAN 2		IN-22KN83/P08	2x60	2x42	2x20	137
TITAN 3		IN-32KN94/P09	3x60	3x42	3x23	152
TITAN 4		IN-42KN10/PM10	4x40	4x28	4x30	183
TITAN 5		IN-62KN11/PM11	6x40	6x28	6x30	183
DELIA 1		IN-12KN62/P22	60	42	15	126
DELIA 2		IN-22KN83/P23	2x60	2x42	2x20	137
DELIA 3		IN-32KN94/P24	3x60	3x42	3x23	152
TILIA 1		IN-22NU2/P32	2x40	2x28	2x20	137
TILIA 2		IN-22NU3/P33	3x40	3x28	3x20	137
TITAN 13 PM		IN-32T10/PM19/S..	3x40	3x28	3x30	183
VEGA	56020	IN-66	2x40	2x28	2x11	144
ISIS 1,L1,S1		Z11,ZL11,ZS11/PE3/.....	100	70	33	196
ISIS 2,L2,S2		Z11,ZL11,ZS11/PE4/.....	100	70	33	196
TITAN T2		IN-22ZT11/P08/L100	2x60	2x42	2x20	137
TITAN T3		IN-32ZT11/P09/L100	3x60	3x42	3x23	152
DELIA T2		IN-22ZT11/P23/L100	2x60	2x42	2x20	137
DELIA T3		IN-32ZT11/P24/L100	3x60	3x42	3x23	152
TITAN L4		IN-42ZL11/PM10/L100	4x40	4x28	4x30	183
TITAN L5		IN-62ZL11/PM11/L100	6x40	6x28	6x30	183
VELA L		IN-42ZL11/PC19/...	4x40	4x28	4x30	183
ELEKTRA 3		IN-152.....	60	42	11	117
ELEKTRA 4,6		IN-172.....	100	70	15	128
ELEKTRA 5	50039	IN-174	2x60	2x42	2x20	137
MEIA		IN-150.....	60	42	11	117

Přehled pictogramů/view of pictograms/Обзор пиктограмм

Piktogramy vhodné pro svítidla z řad LINA, FLORA, JENA / Pictograms suitable for the lighting fittings from the series LINA, FLORA, JENA / Пиктограммы подходят для светильников серий: LINA, FLORA, JENA

Příklad označení piktogramů pro svítidlo JENA 1: 036/Pic 08 (typ stínítka/typ piktogramu)



Pic 01



Pic 04



Pic 07



Pic 02



Pic 05



Pic 08



Pic 03

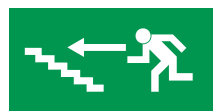

Pic 06



Pic 09









OSMONT, s.r.o.

Hybrálec 129, 586 01 Jihlava

Czech Republic

tel.: +420 567 210 023

+420 567 220 271

fax: +420 567 572 621

e-mail: osmont@osmont.cz

www.osmont.eu

www.osmont.cz