

Manual motor starter MS116

Manual motor starters are electro-mechanical protection devices for the main circuit. They are used mainly to switch motors manually ON/OFF and protect them fuse less against short-circuit, overload and phase failures.

Fuse less protection with a manual motor starter saves costs, space and ensures a quick reaction under short-circuit condition, by switching off the motor within milliseconds. Fuse less starter combinations are setup together with contactors.

Description

- Overload protection – trip class 10A
- Phase loss sensitivity
- Disconnect function
- Temperature compensation from -25 ... +55 °C
- Adjustable current setting for overload protection
- Suitable for three- and single-phase application
- Trip-free mechanism
- Clear switch position indication ON/OFF



Order data

MS116 screw terminal



Setting range	Type	Trip class	Order code	Pack- ing unit	Weight per PCE
A				PCE	kg
0.10...0.16	MS116-0.16	10A	1SAM250000R1001	1	0.225
0.16...0.25	MS116-0.25	10A	1SAM250000R1002	1	0.225
0.25...0.40	MS116-0.4	10A	1SAM250000R1003	1	0.225
0.40...0.63	MS116-0.63	10A	1SAM250000R1004	1	0.225
0.63...1.00	MS116-1.0	10A	1SAM250000R1005	1	0.225
1.00...1.60	MS116-1.6	10A	1SAM250000R1006	1	0.265
1.60...2.50	MS116-2.5	10A	1SAM250000R1007	1	0.265
2.50...4.00	MS116-4.0	10A	1SAM250000R1008	1	0.265
4.00...6.30	MS116-6.3	10A	1SAM250000R1009	1	0.265
6.30...10.0	MS116-10	10A	1SAM250000R1010	1	0.265
8.00...12.0	MS116-12	10A	1SAM250000R1012	1	0.265
10.0...16.0	MS116-16	10A	1SAM250000R1011	1	0.265
16.0...20.0	MS116-20	10A	1SAM250000R1013	1	0.310
20.0...25.0	MS116-25	10A	1SAM250000R1014	1	0.310
25.0...32.0	MS116-32	10A	1SAM250000R1015	1	0.310

Note: MS116 with pre-assembled auxiliary contact HKF1-11, please order as follow 1SAM250005Rxxxx

Functional description

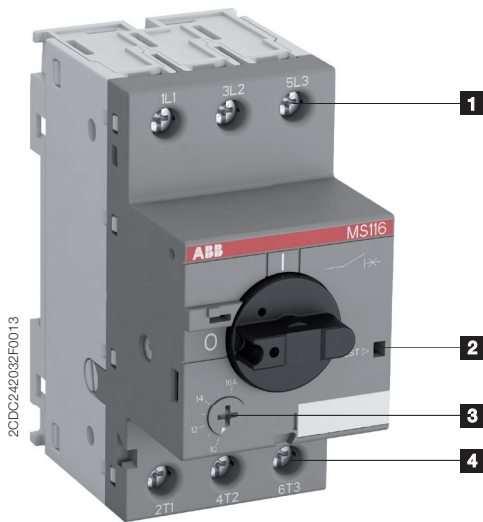

- 1** Terminals 1L1, 3L2, 5L3
- 2** Test function
- 3** Current setting range / Adjustable current setting for overload protection
- 4** Terminals 2T1, 4T2, 6T3

Application

The manual motor starters protect the load and the installation against short-circuit and overload. They are three pole protection devices with thermal tripping elements for overload protection and electromagnetic tripping elements for short-circuit protection. Furthermore, they provide a disconnect function for safely isolation of the installation and the supply and can be used for the manual switching of loads.

The manual motor starters have a setting scale in amperes, which allows the direct adjusting of the device without any additional calculation. In compliance with international and national standards, the setting current is the rated current of the motor and not the tripping current (no tripping at $1.05 \times I$, tripping at $1.2 \times I$; I = setting current).

Operation mode

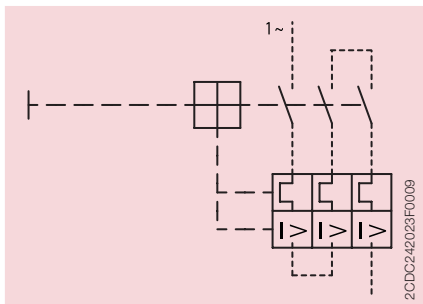

Single-phase operation

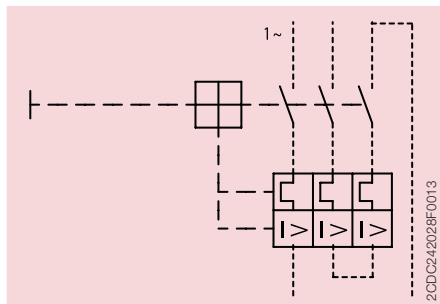

Single-phase operation

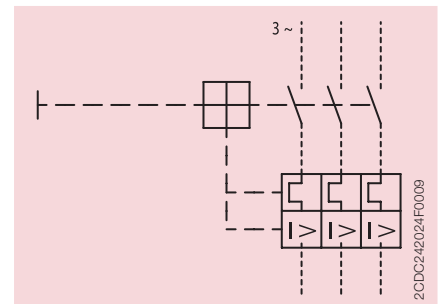

Three-phase operation

Wiring diagram

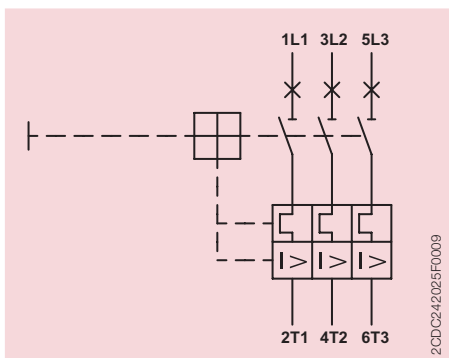

Resistance and power loss per pole

Type	Setting range		Resistance per pole Ω	Power loss per pole	
	lower value A	upper value A		at lower value W	at upper value W
MS116-0.16	0.10	0.16	66.00	0.7	1.7
MS116-0.25	0.16	0.25	25.50	0.7	1.7
MS116-0.4	0.25	0.40	10.38	0.7	1.7
MS116-0.63	0.40	0.63	4.36	0.7	1.7
MS116-1.0	0.63	1.00	1.605	0.7	1.7
MS116-1.6	1.00	1.60	0.648	0.7	1.7
MS116-2.5	1.60	2.50	0.292	0.7	1.8
MS116-4.0	2.50	4.00	0.114	0.7	1.8
MS116-6.3	4.00	6.30	0.046	0.7	1.8
MS116-10	6.30	10.0	0.024	0.9	2.4
MS116-12	8.00	12.0	0.016	1.0	2.3
MS116-16	10.0	16.0	0.011	1.1	2.8
MS116-20	16.0	20.0	0.0057	1.5	2.3
MS116-25	20.0	25.0	0.0045	1.8	2.8
MS116-32	25.0	32.0	0.0030	1.9	3.1

Technical diagram

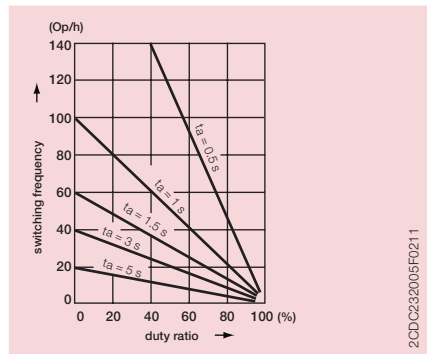

Intermittent periodic duty, t_a : Motor starting time

Dimensions

in mm / inches

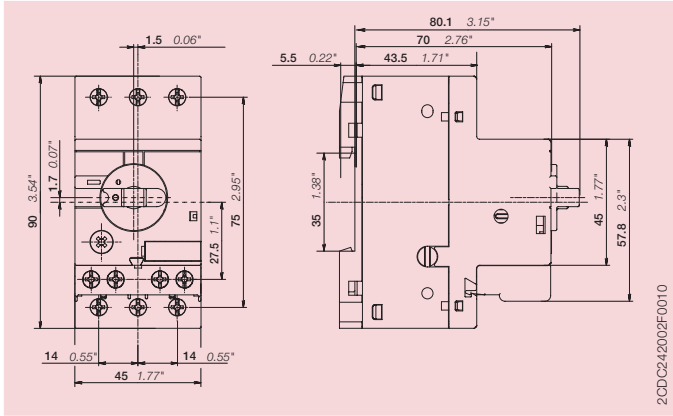

MS116 ≤ 16 A

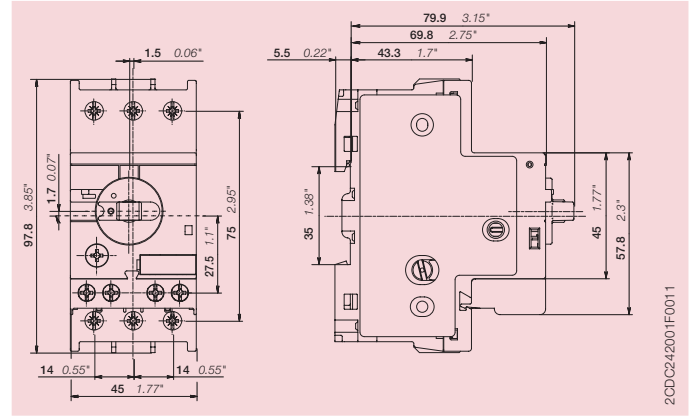

MS116 ≥ 20 A

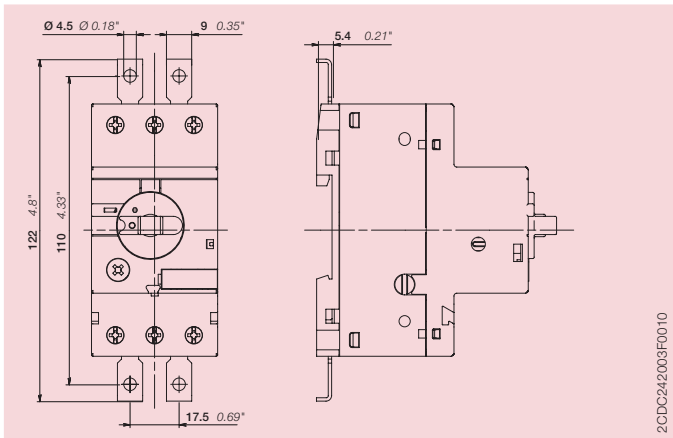

MS116 ≤ 16 A with screw fixing kit FS116 (accessory)

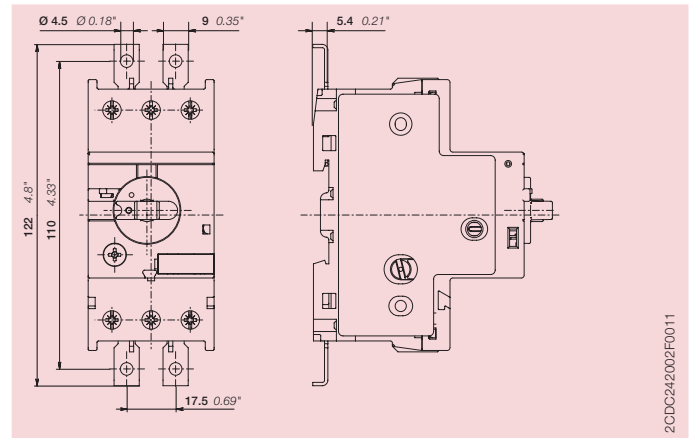

MS116 ≥ 20 A with screw fixing kit FS116 (accessory)

Main accessories for manual motor starter

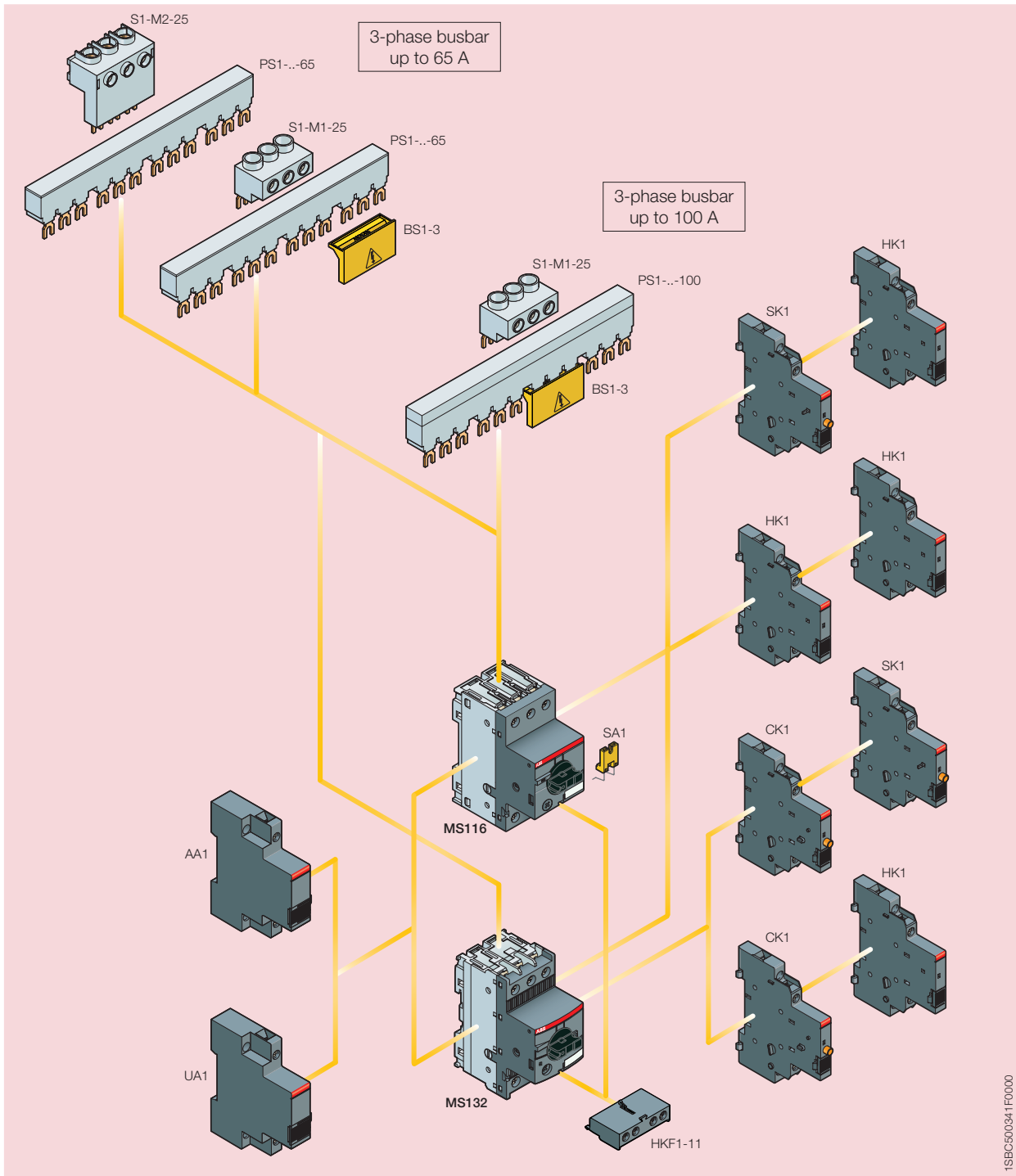

1SBC500341F0000

Technical data IEC/EN

Data at $T_A = 40\text{ °C}$ and at rated values, if nothing else indicated

Main circuit

	1L1-3L2-5L3 2T1-4T2-6T3
Rated operational voltage U_e	690 V AC - V DC
Setting range - thermal overload protection	see table "Order data" on page 1
Rated operational current I_e	see table below
Rated instantaneous short-circuit current setting I_i	see table below
Rated service short-circuit breaking capacity I_{cs}	see table "Short-circuit breaking capacity and back-up fuses" on page 8
Rated ultimate short-circuit breaking capacity I_{cu}	see table "Order data" on page 1
Trip class	50/60 Hz
Rated frequency	3
Number of poles	see table "Resistance and power loss per pole" on page 3
Resistance per pole	
Power loss per pole	

Isolation data

Rated impulse withstand voltage U_{imp}	6 kV
Rated insulation voltage U_i	690 V
Pollution degree	3

Electrical connection		MS116 ≤ 16 A	MS116 ≥ 20 A
Connecting capacity	solid	1/2 x 1 ... 4 mm ²	1/2 x 1 ... 2.5 mm ² 1/2 x 2.5 ... 6 mm ²
	stranded	1/2 x 1 ... 4 mm ²	1/2 x 1 ... 2.5 mm ² 1/2 x 2.5 ... 6 mm ²
	flexible with ferrule	1/2 x 0.75 ... 2.5 mm ²	1/2 x 0.75 ... 6 mm ²
	flexible with insulated ferrule	1/2 x 0.75 ... 2.5 mm ²	1/2 x 0.75 ... 6 mm ²
	flexible without ferrule	1/2 x 0.75 ... 2.5 mm ²	1/2 x 1 ... 2.5 mm ² 1/2 x 2.5 ... 6 mm ²
Stripping length		9 mm	10 mm
Tightening torque		0.8 ... 1.2 Nm	2 Nm
Recommended screw driver		M3.5	M4

Type	Rated instantaneous short-circuit current setting I_i	Rated operational current I_e
	A	A
MS116-0.16	2.00	0.16
MS116-0.25	3.13	0.25
MS116-0.4	5.00	0.40
MS116-0.63	7.88	0.63
MS116-1.0	12.50	1.0
MS116-1.6	20.00	1.6
MS116-2.5	31.25	2.5
MS116-4.0	50.00	4.0
MS116-6.3	78.75	6.3
MS116-10	150	10
MS116-12	180	12
MS116-16	240	16
MS116-20	300	20
MS116-25	375	25
MS116-32	480	32

General data

Mechanical durability		100000
Electrical durability	MS116 ≤ 16 A	100000
	MS116 ≥ 20 A	50000
Duty time		100 %
Operating frequency without early tripping		up to 15 operations/h or 60 operations/h with 40 % duty ratio, if the motor breaking current $6 \times I_n$ and the motor starting time does not exceed 1 s
Dimensions (W x H x D)		see drawing on page 6
Weight		see table "Order data" on page 1
Mounting		DIN-rail (EN 60715)
Mounting positions		position 1-6 (optional for single mounting)
Group mounting		on request
Minimum distance to other units same type	horizontal	0 mm
	vertical	150 mm
Minimum distance to electrical conductive board	horizontal, up to 400 V	0 mm
	horizontal, up to 690 V	> 1.5 mm
	vertical	75 mm
Degree of protection	housing / main circuit terminals	IP20
Utilization category		A
Maximum operating altitude permissible		up to 2000 m
Maximum operating frequency		170 cycles/h

Electromagnetic compatibility

Electromagnetic compatibility		not applicable
-------------------------------	--	----------------

Environmental data

Ambient air temperature		
Operation	open - compensated	-25 ... +55 °C
	open	-25 ... +70 °C
	enclosed (IB132)	0 ... +40 °C
Storage		-50 ... +80 °C
Ambient air temperature compensation		acc. to IEC/EN 60947-4-1
Resistance to vibrations acc. to IEC 60068-2-6		5g / 3 ... 150 Hz
Resistance to shock acc. to IEC 60068-2-27		25g / 11 ms

Standards / directives

Standards		IEC/EN 60947-1 IEC/EN 60947-2 IEC/EN 60947-4-1 UL 60947-1 UL 60947-4-1
Low Voltage Directive		2006/95/EC
EMC Directive		2004/108/EC
RoHS Directive		2002/95/EC

Short-circuit breaking capacity and back-up fuses

I_{CS} Rated service short-circuit breaking capacity

I_{CU} Rated ultimate short-circuit breaking capacity

I_{CC} Prospective short-circuit current at installation location

Note: Maximum rated current of the back-up fuses if $I_{CC} > I_{CS}$

Type	230 V AC			400 V AC			440 V AC			500 V AC			690 V AC		
	I_{CS} kA	I_{CU} kA	gG, aM A	I_{CS} kA	I_{CU} kA	gG, aM A	I_{CS} kA	I_{CU} kA	gG, aM A	I_{CS} kA	I_{CU} kA	gG, aM A	I_{CS} kA	I_{CU} kA	gG, aM A
MS116-0.16															
MS116-0.25															
MS116-0.4															
MS116-0.63															
MS116-1.0															
MS116-1.6	No back-up fuse required up to $I_{CC} = 50$ kA														
MS116-2.5							10	10	25	10	10	25	5	5	25
MS116-4.0							6	6	25	6	6	25	2	2	25
MS116-6.3							6	6	63	6	6	63	2	2	40
MS116-10							6	6	63	6	6	63	2	2	50
MS116-12	25	25	80	25	25	80	6	6	63	6	6	63	2	2	50
MS116-16	16	16	80	16	16	80	6	6	63	4	4	63	2	2	63
MS116-20	10	15	125	10	15	125	3	6	125	3	4	125	2	2	80
MS116-25	10	15	125	10	15	125	3	6	125	3	4	125	2	2	100
MS116-32	10	10	125	10	10	125	3	6	125	3	4	125	2	2	100

No back-up fuse required up to $I_{CC} = 30$ kA

Technical data UL/CSA

Main circuit

Maximum operational voltage	600 V	
Manual Motor Controller ratings	see table "UL 508 – Manual Motor Controller" on page 10	
Motor ratings	Horse power	see table below
	Full load amps (FLA)	see table below
	Locked rotor amps (LRA)	see table below

Electrical connection		MS116 ≤ 16 A	MS116 ≥ 20 A
Connecting capacity	stranded	1/2 x AWG 16 ... 12	1/2 x AWG 16 ... 8
	flexible without ferrule	1/2 x AWG 16 ... 12	1/2 x AWG 16 ... 8
Stripping length		9 mm	10 mm
Tightening torque		10 ... 12 lb-In	18 lb-In
Recommended screw driver		M3.5	M4

Motor rating, single phase

hp Horse power

FLA Full load amps

LRA Locked rotor amps

Type	120 VAC			220-240 VAC		
	hp	FLA	LRA	hp	FLA	LRA
MS116-0.16	-	0.16	0.96	-	0.16	0.96
MS116-0.25	-	0.25	1.5	-	0.25	1.5
MS116-0.4	-	0.4	2.4	-	0.4	2.4
MS116-0.63	-	0.63	3.78	-	0.63	3.78
MS116-1.0	-	1	6	-	1.0	6.0
MS116-1.6	-	1.6	9.6	1/10	1.5	-
MS116-2.5	-	2.5	15	1/6	2.2	-
MS116-4.0	1/8	4	24	1/3	3.6	-
MS116-6.3	1/4	6.3	37.8	1/2	4.9	-
MS116-10	1/2	9.8	58.8	1-1/2	10	-
MS116-12	1/2	9.8	58.8	2	12	-
MS116-16	1	16	96	2	12	-
MS116-20	1-1/2	20	120	3	17	92
MS116-25	2	24	144	3	17	127
MS116-32	2	24	144	5	28	162

Motor rating, three phase

hp Horse power

FLA Full load amps

LRA Locked rotor amps

Type	220-240 VAC			440-480 VAC			550-600 VAC		
	hp	FLA	LRA	hp	FLA	LRA	hp	FLA	LRA
MS116-0.16	-	0.16	0.96	-	0.16	0.96	-	0.16	0.96
MS116-0.25	-	0.25	1.5	-	0.25	1.5	-	0.25	1.5
MS116-0.4	-	0.4	2.4	-	0.4	2.4	-	0.4	2.4
MS116-0.63	-	0.63	3.78	-	0.63	3.78	-	0.63	3.78
MS116-1.0	-	1.0	6.0	-	1.0	6.0	1/2	0.9	8
MS116-1.6	-	1.6	9.6	3/4	1.6	12.5	3/4	1.3	10
MS116-2.5	1/2	2.2	20	1	2.1	15	1-1/2	2.4	16
MS116-4.0	1	4.2	30	2	3.4	25	3	3.9	25.6
MS116-6.3	1-1/2	6.4	40	3	4.8	32	5	6.1	36.8
MS116-10	3	9.6	64	5	7.6	46	7-1/2	9	50.8
MS116-12	3	9.6	64	7-1/2	11	63.5	10	11	64.8
MS116-16	5	15.2	92	10	20	81	10	11	64.8
MS116-20	5	15.2	92	10	14	81	15	17	93
MS116-25	7-1/2	22	127	15	21	116	20	22	116
MS116-32	10	28	162	20	27	145	25	27	146

UL 508 — Manual Motor Controller

Type	Maximum fuse type K5 o. RK5 per UL/NEC 480 V / 600 V A	Maximum short-circuit current			
		for motor disconnect ¹⁾		for group installation	
		480 V kA	600 V kA	480 V kA	600 V kA
MS116-0.16	100	30	5	18	5
MS116-0.25	100	30	5	18	5
MS116-0.4	100	30	5	18	5
MS116-0.63	100	30	5	18	5
MS116-1.0	100	30	5	18	5
MS116-1.6	100	30	5	18	5
MS116-2.5	100	30	5	18	5
MS116-4.0	100	18	5	18	5
MS116-6.3	100	18	5	18	5
MS116-10	100	18	5	18	5
MS116-12	100	18	5	18	5
MS116-16	100	18	5	18	5
MS116-20	100	18	5	18	5
MS116-25	100	18	5	18	5
MS116-32	100	18	5	18	5

¹⁾ Suitable as motor disconnect only when provided with padlock SA1 or SA3...

Contact us

ABB STOTZ-KONTAKT GmbH

Eppelheimer Straße 82
69123 Heidelberg, Germany
Phone: +49 (0) 6221 7 01-0
Fax: +49 (0) 6221 7 01-13 25
E-Mail: info.desto@de.abb.com

You can find the address of your
local sales organization on the
ABB home page
<http://www.abb.com/contacts>
-> Low Voltage Products and Systems

Note:

We reserve the right to make technical changes or modify the contents of this document without prior notice. With regard to purchase orders, the agreed particulars shall prevail. ABB AG does not accept any responsibility whatsoever for potential errors or possible lack of information in this document.

We reserve all rights in this document and in the subject matter and illustrations contained therein. Any reproduction, disclosure to third parties or utilization of its contents – in whole or in parts – is forbidden without prior written consent of ABB AG.

Copyright© 2014 ABB
All rights reserved